

Setting
the
Standard

CLIPSAL[®]
every room, every home

**STANDARD
SERIES**



No other range
is up to Standard.

Setting
the
Standard

technical data

clipsal.com



STANDARD SERIES

page

CONTENTS

2	STANDARD SERIES INTRODUCTION
4	HOW TO ORDER SECTION
12	STANDARD SERIES COLOURS
	SWITCHES
13	Standard Size Flush Switches
14	Architrave & Miniature Architrave Size Flush Switches
15	Intermediate & Large Format Size Flush Switches
16	Flush Plates
19	Dimmers & Fan Controllers
21	Timer Controls
23	Sunset Switches
23	Switch Multipliers & Booster Element Relay
24	Under Voltage Relays
24	Key Tag & Key Operated Switches
26	Ceiling & Foot Operated Switches
29	Circuit Identification Products & Mounting Accessories
30	Cable Connection Accessories
31	Protected Switches - Moulded and Zinc Diecast
	SOCKETS
32 - 38	Various Socket Outlets
39	Wilco & Clock Connection Accessories
40	Switched Socket Outlets
46	Safety, Cooker Socket & Plug and Universal Shaver Outlets
47	TV Equipment
50	Chemical Resistant Standard Industrial Range
54	Protected Switched Socket Outlets - Zinc Diecast
55	30 SERIES SWITCH MECHANISMS
61	SCHEMATIC WIRING DIAGRAMS
68	MOUNTING TEMPLATES
69	STANDARD RANGE QUICK REFERENCE GUIDE
81	FOLD OUT MOUNTING ACCESSORIES CROSS REFERENCE CHART

SETTING THE STANDARD

STANDARD SERIES

The Clipsal Standard Range of Flush Switches, Socket Outlets and Accessories has been a firm favourite for many years, and with good reason.

With pure, uncluttered styling and timeless lines, Clipsal's Standard Range has stood the test of time.

These accessories make it easy to update or replace switches in the thousands of Australian homes built in the 1970s and 80s that already feature Standard Range products.

Today's Standard Range however, features a greater choice of economical flush switches, sockets and accessories than have ever been available before.

Switches in all sizes from mini architrave to large format can be purchased either assembled or as plates only, along with printed mechanisms for specific functions.



FOR OVER 30 YEARS



Dimmers, fan controllers, time delays, surface, ceiling and other special purpose switches are all available in the Standard Range format.

Socket outlets with features such as Surge Protection, RCD Protection, Timers and Dual Voltage also add to this range to provide for today's requirements.

Approvals and Certification

Where required, all Clipsal Standard Range products have been approved by The Department Of Energy, South Australia, and carry the **Approval Mark S/1**.



HOW TO ORDER SWITCHES

Single/Multi Switch Mechanisms

Clipsal Standard Range products use the 30 Series Switch Mechanism, which is a Trademark of Clipsal Australia Pty. Ltd. Standard Range switches are supplied in **one, two, three, four, five and six-gang formats**, meaning that the gridplate remains the same size, however, a varying number of switch mechanisms may be used.

Standard size switch dimensions are 115mm (length) x 73mm (width) x 11mm (depth).

Each range of switches and socket outlets have different prefixes at the beginning of the Catalogue Number.

The "3" prefix indicates the product is a **Standard Range Switch Product**.

For Standard Range switches that prefix is '3'. For example, a vertically mounted single gang switch in Standard Range is **31VA**.

Note: Depth refers to the dimensions that switchplate protrudes off the wall surface. It does not include the amount the mechanism recesses into the wall.

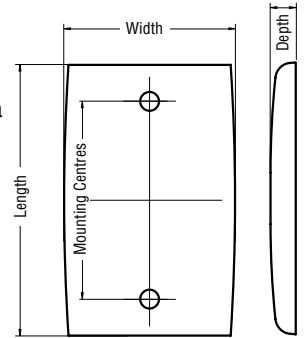

This number indicates the **number of switch mechanisms** included in the product. Note that the size of the gridplate does not change, only the number of switch mechanisms is variable.

3 1 V A

One Gang	Two Gang	Three Gang	Four Gang	Five Gang	Six Gang
31VA	32VA	33VA	34VA	35VA	36VA

Horizontal or Vertical Formats

Standard Range Catalogue Numbers will also vary depending on whether the switch is vertically or horizontally mounted. For example, **31VA is vertically mounted** whereas **31HA is horizontally mounted**. The 'A' in the catalogue number refers to the product being **Assembled**.

3 1 V A

The letter "V" indicates the product is **Vertically Mounted**.

3 1 H A

The letter "H" indicates the product is **Horizontally Mounted**.

One Gang	Two Gang	Three Gang	Four Gang
31HA	31VA	32HA	32VA
33HA	33VA	34HA	

Architrave Switches

Standard Range switches are also available in architrave sizes in **one, two, three and four-gang formats**.

- 30** dimensions are 75mm (l) x 32mm (w) x 10mm (d).
- 32A** dimensions are 85mm (l) x 32mm (w) x 10mm (d).
- 33A** dimensions are 113mm (l) x 32mm (w) x 10mm (d).
- 34A** dimensions are 140mm (l) x 32mm (w) x 10mm (d).

One Gang	Two Gang	Three Gang	Four Gang
30	32A	33A	34A

HOW TO ORDER SWITCHES (continued)

Miniature Architrave Switches

Miniature Architrave size switches are available in **one, two and three gang** formats.

A 'T' in the Catalogue Number refers to "miniature" plate size.

Each format has a different size gridplate.

30T dimensions are 54mm (l) x 27mm (w) x 10mm (d).

32TA dimensions are 75mm (l) x 27mm (w) x 10mm (d).

33TA dimensions are 98mm (l) x 27mm (w) x 10mm (d).

One Gang



30T

Two Gang



32TA

Three Gang



33TA

Intermediate Switches

Intermediate switches are available in **one and two-gang** formats.

A 'B' in the Catalogue Number refers to "intermediate" plate size. An 'L' in the Catalogue Number refers to the mounting centres being spaced further apart.

The gridplate remains the same size for both formats.

31BA & 32BA dimensions are

95mm (l) x 48mm (w) x 11mm (d).

31BLA & 32BLA dimensions are

95mm (l) x 48mm (w) x 11mm (d).

One Gang

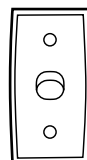

31BA

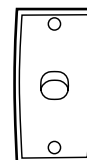

31BLA

Two Gang

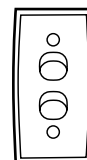

32BA

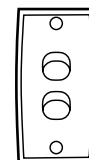

32BLA

Large Format Switches

Large Format switches are available from **one to nine-gang** formats.

The gridplate remains the same size for all formats.

Dimensions are 116mm (l) x 116mm (w) x 11mm (d) for all products.

3 1/2 V A

The "/2" indicates the gridplate is larger than standard or approximately 50% wider.

One Gang

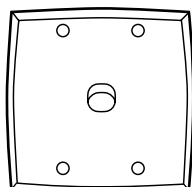

31/2VA

Two Gang

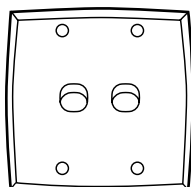

32/2VA

Three Gang

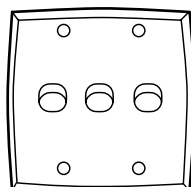

33/2VA

Four Gang

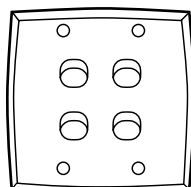

34/2VA

Five Gang

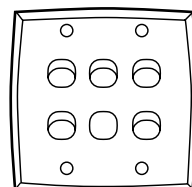

35/2VA

Six Gang

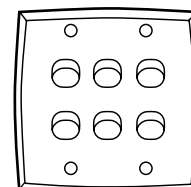

36/2VA

Seven Gang

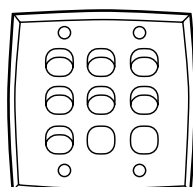

37/2VA

Eight Gang

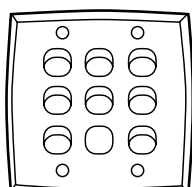

38/2VA

Nine Gang

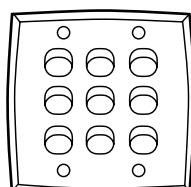

39/2VA

HOW TO ORDER FLUSH PLATES

Standard Range switches can also be purchased with flush plate only (no switch mechanisms). Note "A" is not part of the catalogue number which means no mechanisms are "assembled" in the plate.

See below for one-gang through to six-gang Catalogue Numbers (please note that the 'VH' part of the Catalogue Number means that mechanisms can be mounted either vertically or horizontally).

Standard Size Flush Plates

One Gang

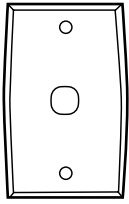

31VH

Two Gang

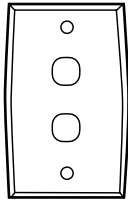

32VH

Three Gang

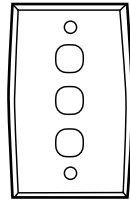

33VH

Four Gang

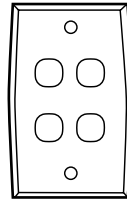

34VH

Five Gang

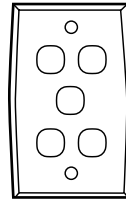

35VH

Six Gang

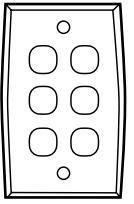

36VH

Miniature Architrave Flush Plates

One Gang



31T

Two Gang



32T

Three Gang



33T

Architrave Flush Plates

One Gang



31

Two Gang



32

Three Gang



33

Four Gang



34

Intermediate Flush Plates

One Gang

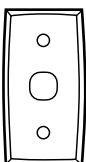

31B

One Gang

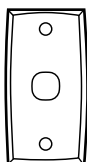

31BL

Two Gang

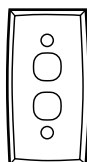

32B

Two Gang

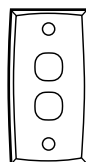

32BL

HOW TO ORDER FLUSH PLATES AND NON-STANDARD SWITCHES

Large Format Flush Plates

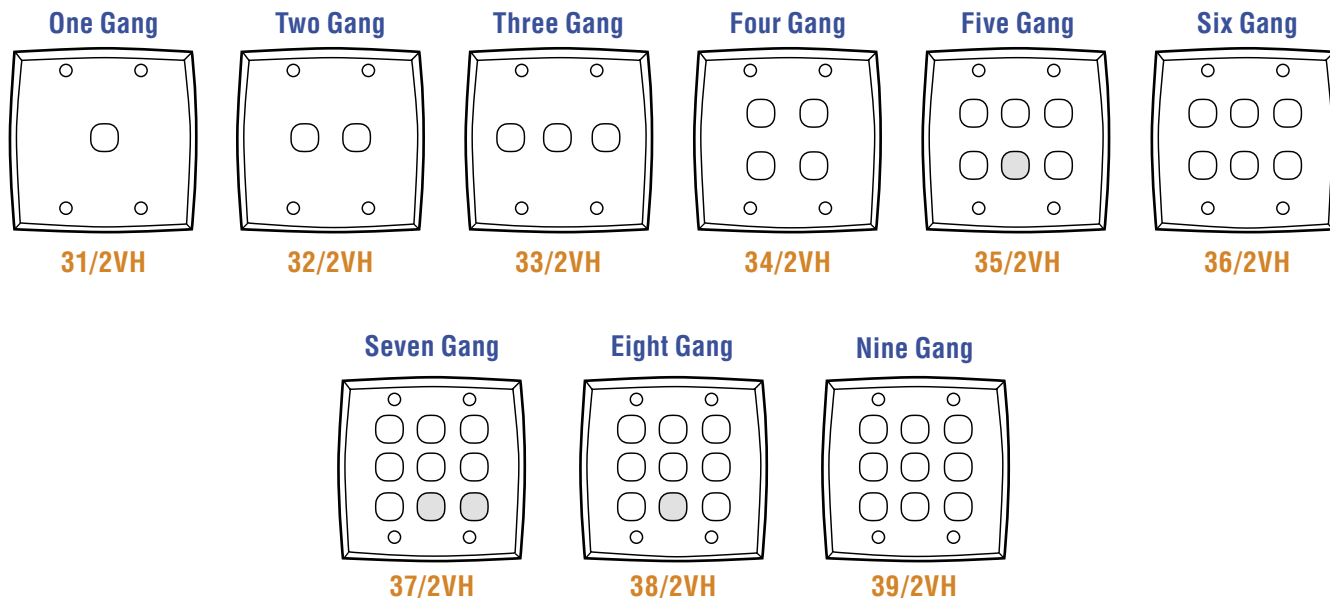

Note  depicts aperture is filled in.

How To Order Non-Standard Switches

Switches can also be ordered with features, including neon switch mechanisms and indicators, dimmers, fan controllers, timers, credit card operation, weatherproof versions and other variations.

Message and Neon Indicator Mechanisms:

Message mechanisms are available in an endless amount of configurations (see Pages 57-60 for more details). Neon indicator mechanisms include **30N-RED** & **30N-COLOURS**. **30/2NM** is a switch mechanism with a neon indicator. Please note that flush plates must be purchased separately for these products.

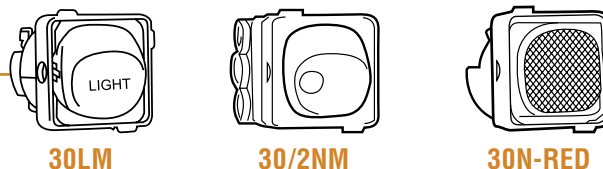

30LM

30/2NM

30N-RED

Sunset Switches

Catalogue number arrangement is formed as follows:
31VSSR.

- '31' refers to Single Switch Plate
- 'V' refers to Vertical orientation
- 'SS' refers to Sunset Switch
- 'R' refers to with Relay

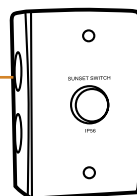

31VSSR

Light Dimmers:

include **32E450L** (C-Thru® Leading Edge),
32E450T (C-Thru® Trailing Edge).

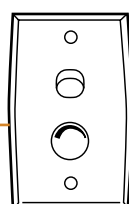

32E450L

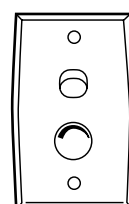

32E450T

Fan Speed Controller:

is **32E500F**.

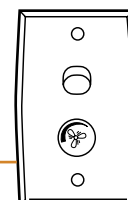

32E500F

HOW TO ORDER NON-STANDARD SWITCHES (CONTINUED)

Timers - Electronic:

include **31VETR**, **31VETR3** & **31VETF** (fans).

'ET' refers to Electronic Timer.

'R' refers to Relay (2 wire, no neutral required).

'R3' refers to 3 Wire Relay (3 wire, neutral required).

'F' refers to Fan.

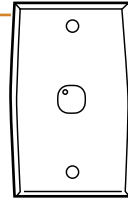

**31VETR &
31VETR3**

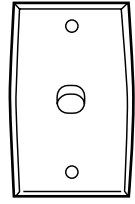

31VETF

Timers - Pneumatic:

include **319**, **319RA**, **319N**, **319HP** & **319X**.

All Pneumatic timer products are prefixed with '319'.

'RA' refers to a Reverse Action (operation).

'N' means that the product includes a Neon.

'HP' refers to the product being Hose Proof (weatherproof).

'X' means that the product is supplied with an extra switch.

NOTE: Analogue timers are also available, refer page 22.

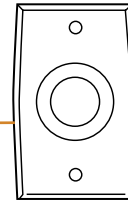

319

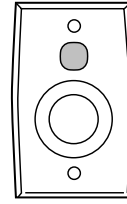

319N



319HP

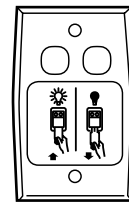

36VKT3N & 36VKT4

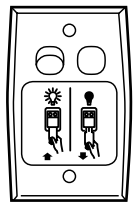
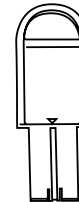

36VKT3NX & 36VKT4X

Key Tag Switches:

include **36VKT3N**, **36VKT3NX**, **36VKT4**, **36VKT4X**.

'V' refers to Vertical.

'KT' refers to Key Tag.

'N' refers to Neon.

'X' refers to Extra Switch.

Key Operated Switches:

include **31VK1**, **31VK1/2**, **31VK2**, **31VK2/2**.

'K1' refers to Key Operated 'One Way' Switch.

'K1/2' refers to Key Operated 'Two Way' Switch.

'K2' refers to Key Operated, Locking in both On/Off Positions.

'K2/2' refers to Key Operated 'Two Way', Locking in both On/Off Positions.

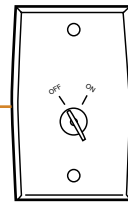

31VK1



**31VK1/2 &
31VK2/2**

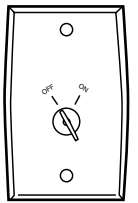

31VK2

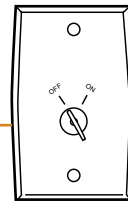

31VK1CK



**31VK1/2CK &
31VK2/2CK**

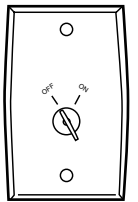

31VK2CK

Common Keyed Switches:

include **31VK1CK**, **31VK1/2CK**, **31VK2CK**, **31VK2/2CK**.

'CK' - By adding "CK" to Key Operated Switches allows for 'One Common Key' to be used across all switches.

IP54 Weatherproof Switch:

is **31VHWP**.

'WP' refers to Weather Proof.

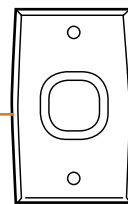

31VHWP



HOW TO ORDER TELEPHONE, DATA AND TV CONNECTION ACCESSORIES



Telephone and Data Outlets

The following accessory is available:

One Gang Data Outlet

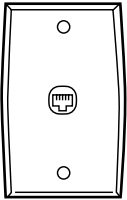

31VRJ

TV Antenna Connection Accessories

The following accessories are available:

TV Outlet Plate

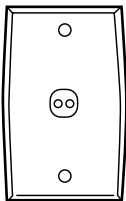

31VTVA

Coaxial TV Socket 75 Ohm

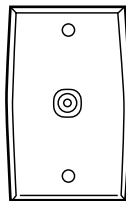

31VTV75

TV Socket 3kVAc Isolation, 75 Ohm

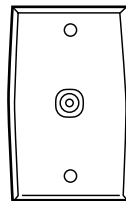

31VTV75ACF

TV Socket F Type Connection, 75 Ohm

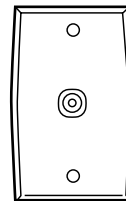

31VTV75F

TV-FM Splitter Standard Plate

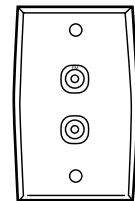

32VTV75FM

Pay TV Socket marked 'PAY TV'



31TVF

Pay TV & FTA TV AC Isolation, Standard Plate

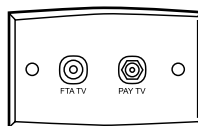

32TVACFF

Pay TV & FTA TV F Type, Standard Plate

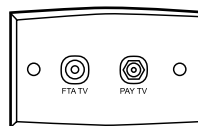

32TVFF

Pay TV & FTA TV Screw Coaxial, Standard Plate

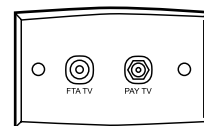

32TVSF

Ordering Colours

When ordering switches, colour variations also have to be taken into consideration, as the Catalogue Number will change depending on the colour of the product. Each colour has its own 'code', for example, the code for White Electric is 'WE' and the code for Cream is 'CM'. The Catalogue Number for a Standard Range One-Gang Vertically Mounted Switch in White Electric is 31VA,WE.

Refer to 'Standard Range Colours' on page 12 for colour options and their corresponding codes.



HOW TO ORDER SWITCHED SOCKET OUTLETS

Switched Socket Outlets are often referred to as GPO's (General Purpose Outlets), Power Points or Power Outlets. So that there is no confusion, the description 'Switched Socket Outlets' will be used throughout this brochure. Single and twin Socket Outlets are available in the Standard Range in horizontal and vertical formats.

Catalogue Numbers will vary depending on the number of sockets and whether the product is horizontally or vertically mounted. Single Switched Socket Outlet dimensions are 115mm (length) x 73mm (width) x 14mm (depth). Twin Switched Socket Outlet dimensions are 115mm (l) x 72mm (w) x 14mm (d).

This number indicates the **number of sockets** included in the product. The plate size remains the same for both single and twin switched socket outlets, only the number of switches and sockets vary.

15V

The letter 'V' indicates that the product is **vertically mounted**. Where there is no letter 'V', the product is **horizontally mounted**.

Single Horizontal

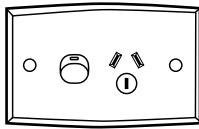

15

Single Vertical

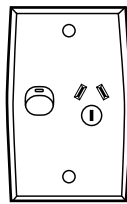

15V

Twin Horizontal

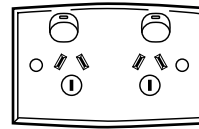

25

Twin Vertical

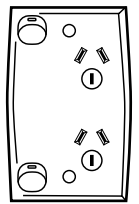

25V

Please note: Single and Twin Automatically Switched Socket Outlets are also available (Catalogue Numbers **10** and **20**).

10 dimensions are 115mm (l) x 73mm (w) x 16mm (d).

20 dimensions are 115mm (l) x 73mm (w) x 16mm (d).

If a Quad Socket Outlet is required, this will only be achieved by using the Classic C2000 Range (Catalogue Number C2015D4).

Large Format Switched Socket Outlets

The Catalogue Number for a Single Switched Large Format Socket Outlet is **15/2**, whereas for a Twin Switched Large Format Socket Outlet it is **23**.

15/2 dimensions are 115mm (l) x 115mm (w) x 14mm (d).

23 dimensions are 145mm (l) x 86mm (w) x 15mm (d).

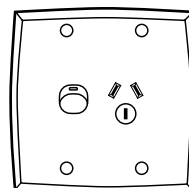

15/2

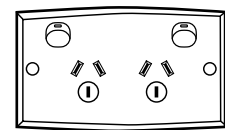

23

Intermediate Switched Socket Outlets

The Standard Range also includes a Single Switched Intermediate size Socket Outlet, Catalogue Number **14**.

Dimensions are 115mm (l) x 61mm (w) x 13mm (d).

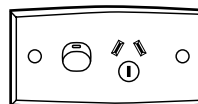

14

Skirting Mounted Switched Socket Outlets

Single Automatic (Catalogue Number **11**), Twin Automatic (Catalogue Number **11/2**), Single Switched (Catalogue Number **16**), and Twin Switched (Catalogue Number **16/2**) Skirting Mounted Socket Outlets available.

11 dimensions are 99mm (l) x 45mm (w) x 17mm (d).

11/2 dimensions are 125mm (l) x 50mm (w) x 17mm (d).

16 dimensions are 99mm (l) x 45mm (w) x 14mm (d).

16/2 dimensions are 168mm (l) x 45mm (w) x 13mm (d).



11/2

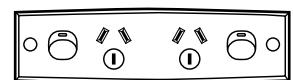

16/2

HOW TO ORDER SWITCHED SOCKET OUTLETS (Continued)

Special Features and Options

Standard Range Socket Outlets may also be ordered with special features, including an extra switch mechanism, safety shutters, neons, double pole switched versions, deep plate format products and more. For example, a Single Combination Switched Socket Outlet may be ordered with Safety Shutters (Catalogue Number **15S**). Please see the main part of the brochure for Combination and Automatically Switched Socket Outlets with special features.



Ordering Colours

When ordering switched socket outlets, colour variations also have to be taken into consideration, as the Catalogue Number will change depending on the colour of the product. Each colour has its own 'code', for example, the code for White Electric is '**WE**' and the code for Cream is '**CM**'. The Catalogue Number for a Standard Range Twin Switched Socket Outlet in White Electric is 25,**WE**.

Refer to 'Standard Range Colours' on page 12 for colour options and their corresponding codes.

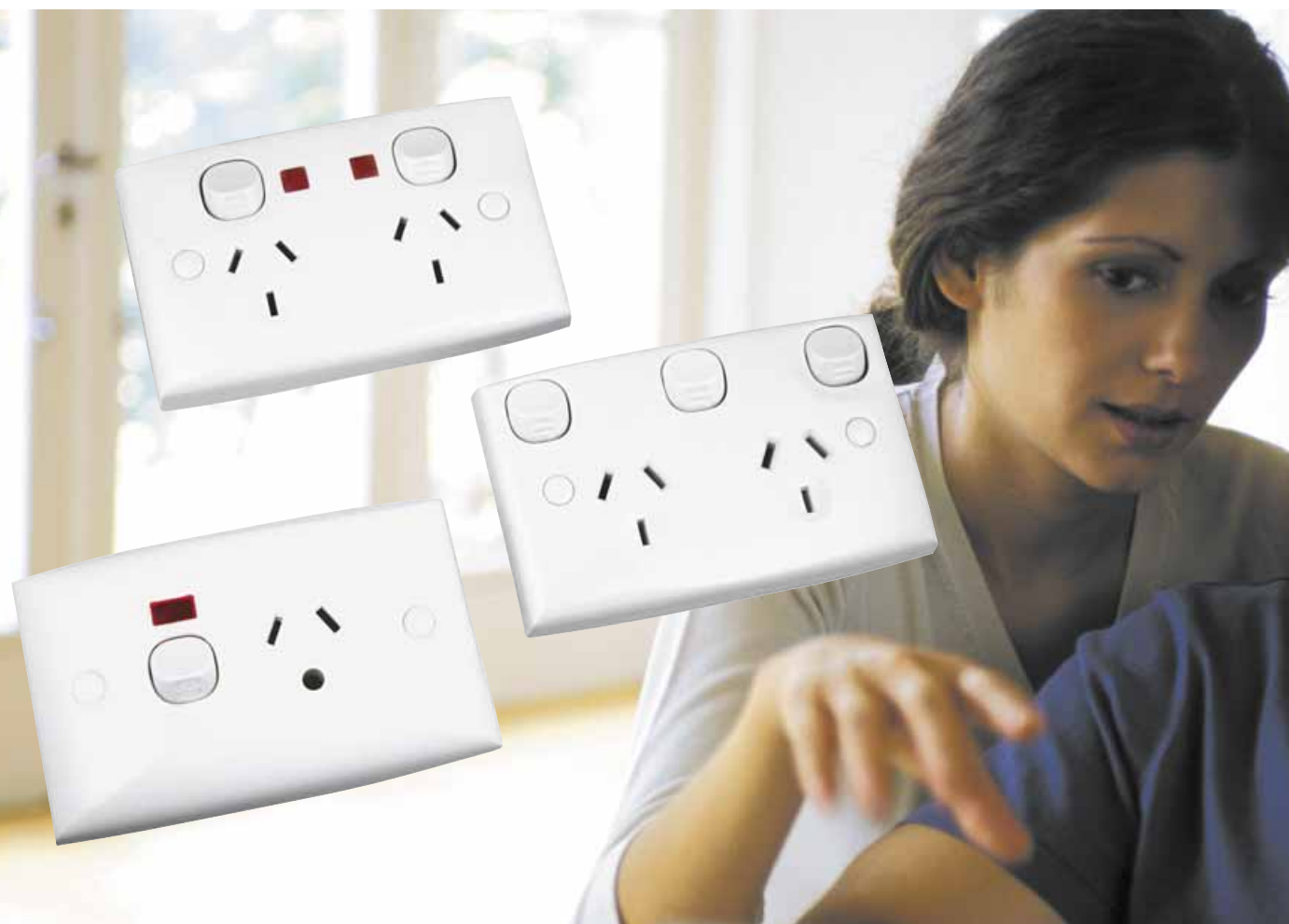
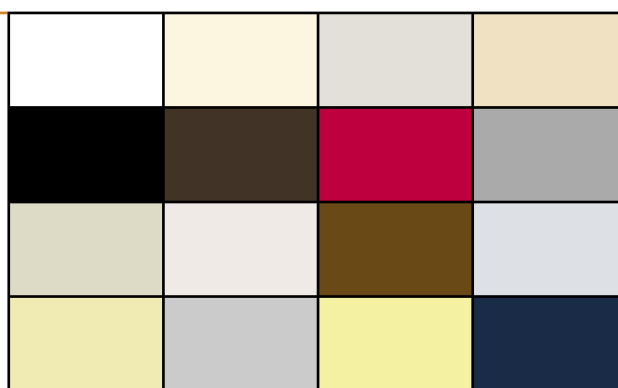

STANDARD SERIES COLOURS

The Standard Range offers an unsurpassed choice of decorator colours, from subtle hues to bold vibrant colours for maximum impact. Five colours are available as standard and a further six colours available for a small surcharge. Two chemical resistant colours are available at standard prices.

Each colour has its own code, which must be added to the end of the Catalogue Number, if that particular colour is desired. For example, if a Vertically Mounted Single Switch in White Electric is desired, the Catalogue Number is **31VA,WE**.

Standard Colours

White Electric - WE



Cream - CM



Soft Grey - SG



Desert Sand - DS



Brown - BR



Black - BK



Surcharge Colours

Red - RD



Grey - GY



Beige - BG



Dove Grey - DO



Nutmeg - NU



Chemical Resistant Colours

Chemical White - RW



Chemical Soft Grey - RS



SWITCHES



Standard Size Flush Switches

These impact resistant flush plates mount to all standard pattern mounting brackets and wall boxes. Being the most common plate size in the Standard Range, it also offers the largest choice of options.

All vertical models can be converted to horizontal by removing mechanisms and turning them 90° before replacing. All models have a base projection of 15mm and room projection of 11mm.

STANDARD SIZE FLUSH SWITCHES - HORIZONTAL MOUNTING				
Cat. No.	Length	Width	Depth	Mounting Centres
All Products	115mm	73mm	11mm	84mm apart
31HA	A	1 Gang Switch, 250V/10A, 1 way/2 way.		
32HA	B	2 Gang Switch, 250V/10A, 1 way/2 way.		
33HA	C	3 Gang Switch, 250V/10A, 1 way/2 way.		
34HA	D	4 Gang Switch, 250V/10A, 1 way/2 way.		



STANDARD SIZE FLUSH SWITCHES - VERTICAL MOUNTING				
Cat. No.	Length	Width	Depth	Mounting Centres
All Products	115mm	73mm	11mm	84mm apart
31VA	A	1 Gang Switch, 250V/10A, 1 way/2 way.		
32VA	B	2 Gang Switch, 250V/10A, 1 way/2 way.		
33VA	C	3 Gang Switch, 250V/10A, 1 way/2 way.		
34VA	D	4 Gang Switch, 250V/10A, 1 way/2 way.		
35VA	E	5 Gang Switch, 250V/10A, 1 way/2 way.		
36VA	F	6 Gang Switch, 250V/10A, 1 way/2 way.		

ARCHITRAVE AND MINIATURE ARCHITRAVE SIZE FLUSH SWITCHES

Architrave Size Flush Switches

Architrave switches are available in models with one to four switches. Also available is a single switch model with a deep plate and a double pole version for caravans, mobile homes and similar.

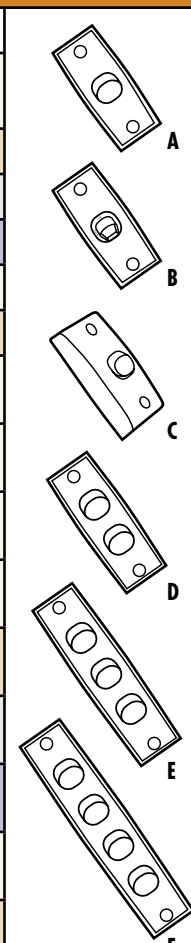

ARCHITRAVE SIZE FLUSH SWITCHES				
Cat. No.	Length	Width	Depth	Mounting Centres
30, 30D, 30/15, 30D15	75mm	32mm	10mm	55mm apart
39	75mm	32mm	10mm	55mm apart
30DD	77mm	35mm	18mm	55mm apart
32A	85mm	32mm	10mm	70mm apart
33A	113mm	32mm	10mm	97mm apart
34A	140mm	32mm	10mm	124mm apart
30	A	1 Gang Switch, 250V/10A, 1 way/2 way.		
30D	A	1 Gang Switch, 250V/10A, 1 way, double pole.		
30/15	A	1 Gang Switch, 250V/15A, 1 way/2 way.		
30D15	A	1 Gang Switch, 250V/15A, 1 way, double pole.		
39	B	1 Gang Switch, 250V/10A, 1 way/2 way, 3 position - Low/Off/High.		
30DD	C	1 Gang Switch, 250V/10A, 1 way, double pole, deep plate.		
32A	D	2 Gang Switch, 250V/10A, 1 way/2 way.		
33A	E	3 Gang Switch, 250V/10A, 1 way/2 way.		
34A	F	4 Gang Switch, 250V/10A, 1 way/2 way.		

Miniature Architrave Switches

Miniature Architrave switches are available in single, two or three gang models. They are designed for use in areas where space is at a premium. All models are suitable only for direct fixing.

MINIATURE ARCHITRAVE SWITCHES				
Cat. No.	Length	Width	Depth	Mounting Centres
30T	54mm	27mm	10mm	40mm apart
32TA	75mm	27mm	10mm	60mm apart
33TA	98mm	27mm	10mm	83mm apart
30T	A	1 Gang Switch, 250V/10A, 1 way/2 way.		
32TA	B	2 Gang Switch, 250V/10A, 1 way/2 way.		
33TA	C	3 Gang Switch, 250V/10A, 1 way/2 way.		

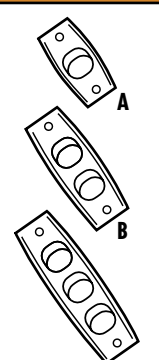
INTERMEDIATE AND LARGE FORMAT SIZE FLUSH SWITCHES

Intermediate Size Switches

One or two gang intermediate size models offer the convenience of either wall or architrave mounting. This range offers the option of two mounting centres, 55mm (B) and 78mm (BL).

INTERMEDIATE SIZE SWITCHES				
Cat. No.	Length	Width	Depth	Mounting Centres
31BA, 32BA	95mm	48mm	10mm	55mm apart
31BLA, 32BLA	95mm	48mm	10mm	78mm apart
31BA	A	1 Gang Switch, 250V/10A, 1 way/2 way (95 x 48mm at centre).		
32BA	B	2 Gang Switch, 250V/10A, 1 way/2 way (95 x 48mm at centre).		
31BLA	C	1 Gang Switch, 250V/10A, 1 way/2 way (95 x 48mm at centre).		
32BLA	D	2 Gang Switch, 250V/10A, 1 way/2 way (95 x 48mm at centre).		

Large Format Size Flush Switches

These Large Format Switches are used mainly to replace older accessories, particularly in locations such as hospitals and schools. Impact resistant, the flush plates are available with up to nine mechanisms.

Plates mount to Standard two gang pattern 157/2 and 164/2 Metal Wall Boxes, 257D2 PVC Deep Wall Boxes, 448 and 448SD Surface Mounting Blocks, 156/2 Mounting Brackets and 154/2 Mounting Clips.

All Large Format Switches have a base projection of 14mm.

LARGE FORMAT SIZE FLUSH SWITCHES - VERTICAL MOUNTING				
Cat. No.	Length	Width	Depth	Mounting Centres
All Products	116mm	116mm	11mm	84 x 46mm
31/2VA	A	1 Gang Switch, 250V/10A, 1 way/2 way.		
32/2VA	B	2 Gang Switch, 250V/10A, 1 way/2 way.		
33/2VA	C	3 Gang Switch, 250V/10A, 1 way/2 way.		
34/2VA	D	4 Gang Switch, 250V/10A, 1 way/2 way.		
35/2VA	E	5 Gang Switch, 250V/10A, 1 way/2 way.		
36/2VA	F	6 Gang Switch, 250V/10A, 1 way/2 way.		
37/2VA	G	7 Gang Switch, 250V/10A, 1 way/2 way.		
38/2VA	H	8 Gang Switch, 250V/10A, 1 way/2 way.		
39/2VA	I	9 Gang Switch, 250V/10A, 1 way/2 way.		

FLUSH PLATES



Standard Size Flush Plates

Flush plates can be purchased without the 30M Switch for convenience and increased choice. They are available in Miniature, Architrave, Standard and Large Format sizes.

A series of blank plates are also available for particular applications, such as the termination of unused or looped cables, mounting of custom equipment or simply blanking off unused openings in wall/wall cladding.

Unused 'gangs' can be blanked off with 30P. (see Page 60).

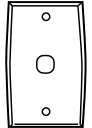
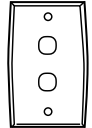
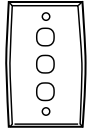
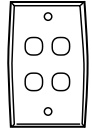
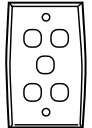
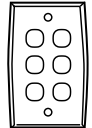
STANDARD SIZE FLUSH PLATES				
Cat. No.	Length	Width	Depth	Mounting Centres
All Products	115mm	73mm	11mm	84mm apart
31VH	A	1 Gang Flush Plate.		
32VH	B	2 Gang Flush Plate.		
33VH	C	3 Gang Flush Plate.		
34VH	D	4 Gang Flush Plate.		
35VH	E	5 Gang Flush Plate.		
36VH	F	6 Gang Flush Plate.		
31VX	G	Blank Flush Plate.		
31VXCB	G	Blank Flush Plate, with 30A terminal block.		











31VH





35VH

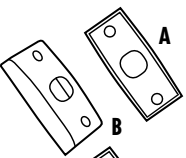
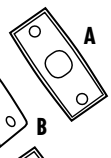
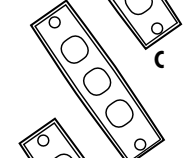
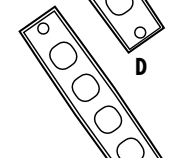
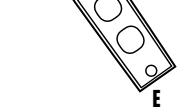

31VX

ARCHITRAVE SIZE FLUSH PLATES				
Cat. No.	Length	Width	Depth	Mounting Centres
31	75mm	32mm	11mm	55mm apart
31D	77mm	35mm	18mm	55mm apart
32	85mm	32mm	11mm	70mm apart
33	113mm	32mm	11mm	97mm apart
34	140mm	32mm	11mm	124mm apart
31	A	1 Gang Flush Plate.		
31D	B	1 Gang Flush Plate, deep.		
32	C	2 Gang Flush Plate.		
33	D	3 Gang Flush Plate.		
34	E	4 Gang Flush Plate.		









31D



32



34

MINIATURE ARCHITRAVE SIZE FLUSH PLATES

Cat. No.	Length	Width	Depth	Mounting Centres
31T	54mm	27mm	10mm	40mm apart
32T	75mm	27mm	10mm	60mm apart
33T	98mm	27mm	10mm	83mm apart
31T	A	1 Gang Flush Plate.		
32T	B	2 Gang Flush Plate.		
33T	C	3 Gang Flush Plate.		

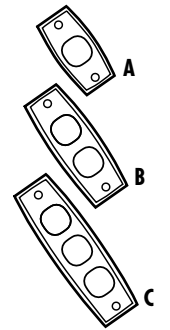

INTERMEDIATE SIZE FLUSH PLATES

Cat. No.	Length	Width	Depth	Mounting Centres
31B	95mm	48mm	10mm	55mm apart
32B	95mm	48mm	10mm	55mm apart
31BL	95mm	48mm	10mm	78mm apart
32BL	95mm	48mm	10mm	78mm apart
31B	A	1 Gang Flush Plate, with 55mm mounting centres.		
32B	B	2 Gang Flush Plate, with 55mm mounting centres.		
31BL	C	1 Gang Flush Plate, with 78mm mounting centres.		
32BL	D	2 Gang Flush Plate, with 78mm mounting centres.		

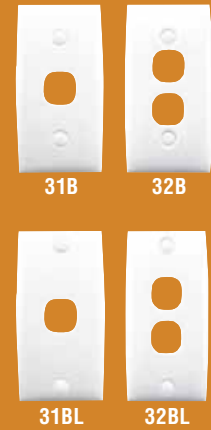
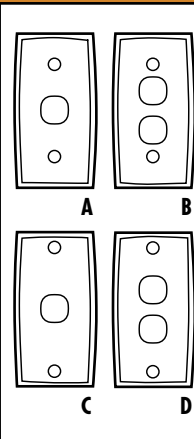

LARGE FORMAT SIZE FLUSH PLATES - VERTICAL MOUNTING

Cat. No.	Length	Width	Depth	Mounting Centres
31/2VX, 31/2V, 32/2V, 33/2V, 34/2V, 35/2V, 36/2V, 37/2V, 38/2V, 39/2V	116mm	116mm	11mm	84mm x 46mm
31/3VX	162mm	115mm	11mm	84mm x 46mm x 46mm
31/2VX	A	1 Gang Blank Flush Plate.		
31/2V	B	1 Gang Flush Plate.		
32/2V	C	2 Gang Flush Plate.		
33/2V	D	3 Gang Flush Plate.		
34/2V	E	4 Gang Flush Plate.		
35/2V	F	5 Gang Flush Plate.		
36/2V	G	6 Gang Flush Plate.		
37/2V	H	7 Gang Flush Plate.		
38/2V	I	8 Gang Flush Plate.		
39/2V	J	9 Gang Flush Plate.		
31/3VX	K	3 Gang Blank Flush Plate.		

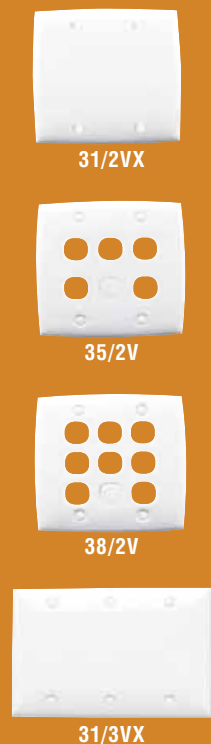
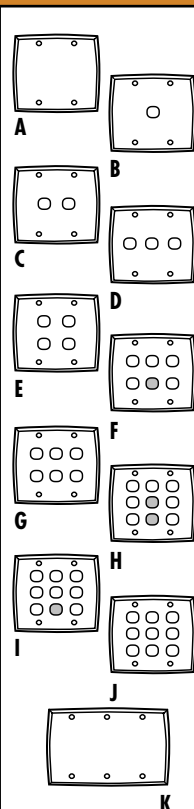

FLUSH PLATES, DATA COMMS. & WEATHERPROOF SWITCHES

SKIRTING SIZE FLUSH PLATES

Cat. No.	Length	Width	Depth	Mounting Centres
31BMF, 32BMF	99mm	45mm	18mm	78mm apart
35BMF	156mm	45mm	18mm	136mm apart
31BMF	A	1 Gang Flush Plate.		
32BMF	B	2 Gang Flush Plate.		
35BMF	C	5 Gang Flush Plate.		

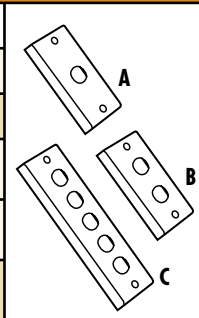

JUNCTION BOX MOUNTED FLUSH PLATE

Cat. No.	Diameter	Depth	Mounting Centres
31VR	70mm Ø	24mm	51mm
31VR	A	Round Plate, suits J.Box Mounting (70mm diameter).	

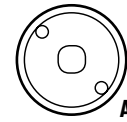

Data Comms. Accessory

TELEPHONE/DATA OUTLET PLATE

Cat. No.	Length	Width	Depth	Mounting Centres
31VRJ	115mm	73mm	11mm	84mm apart
31VRJ	A	Telephone/Data Outlet Plate, with Cat 3 RJ45 Socket.		

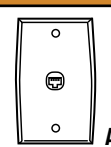

Multi-gang Telephone/Data plates should be ordered by purchasing RJ45 Sockets and Plates separately.

IP54 Rated Weatherproof Switch

The 31VHWP is an attractive switchplate designed for use in outdoor locations such as stairwells, barbecue areas and gazebos.

Completely weatherproof, the switchplate is particularly suitable for 30 Series illuminated press buttons and switch mechanisms that are easy to see at night.

The secret of the switchplate is the translucent rubber membrane that keeps out water and dust, yet still enables easy switching.



For more information, check the Clipsal Standard Range Weatherproof Switchplate flyer O/N 17771.

IP54 RATED WEATHERPROOF FLUSH SWITCH

Cat. No.	Length	Width	Depth	Mounting Centres
31VHWP	115mm	73mm	11mm	84mm apart
31VHWP	A	1 Gang Weatherproofed Switch Plate (IP54 rated).		

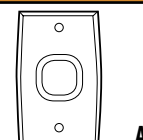

C-THRU® LIGHT DIMMERS & FAN CONTROLLERS

A Clipsal C-Thru® Light Dimmer lets you adjust the lighting levels in any area, for any occasion. For instance, you may want to add a little romance to an intimate dinner, create the right mood for a movie, or leave just enough light on to navigate your way to the bathroom during the night.

In commercial environments too, light dimmers have an almost endless number of applications. Auditoriums, restaurants and boardrooms are just a few of the possible locations in which a light dimmer will offer you full control of lighting to suit any occasion, and the new C-Thru® Light Dimmers enable you to choose the right dimmer, first time - every time.

In a market first, Clipsal has teamed up with other industry leaders and lighting manufacturers to colour code both dimmer and load, allowing unprecedented ease in compatible product selection. Never before has it been so simple to choose the right dimmer or fan control product to suit your application.

The C-Thru® Light Dimmer unit comprises a separately switched, compact, modular dimming mechanism rated at 450W (1.8A). The units utilise state-of-the-art Leading Edge and Trailing Edge dimming technology to provide full control of incandescent and low voltage lighting (using either iron core or electronic transformers).

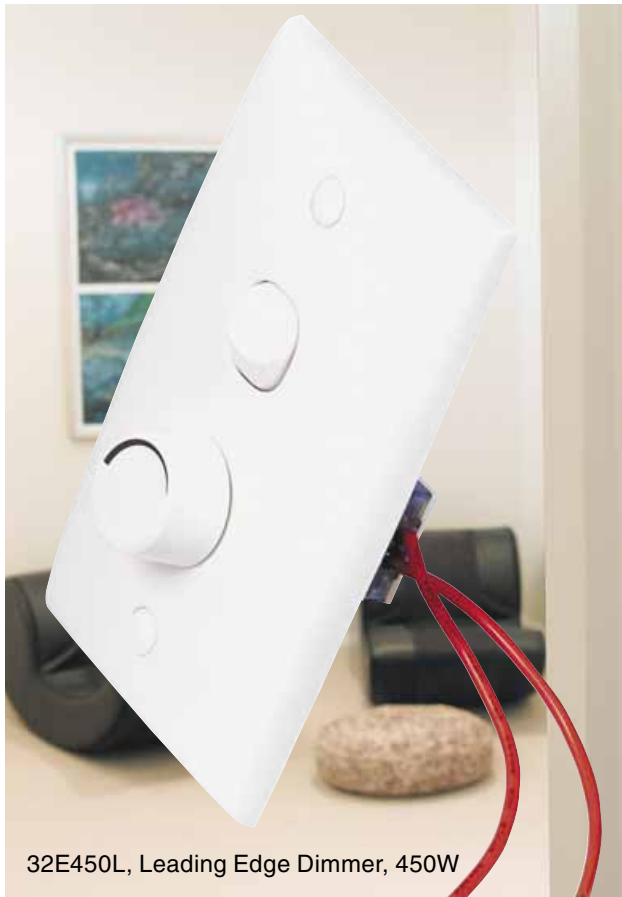

32E450L, Leading Edge Dimmer, 450W

The C-Thru® Product Range is suitable for use in any new installation, but is also retrofittable, and may be used to replace a standard switch in any existing installation.

Please note that the C-Thru® Range of Dimmer and Fan Speed Control products is immune to the effects of high frequency (ripple) signal injection on the mains voltage supply. These signals are commonly injected onto the mains by the supply authority for such applications as off-peak hot water switching and remote meter monitoring. This unique Australian design innovation ensures true flicker-free dimming operation.

Load Compatibility

Each product in the Clipsal C-Thru® Product Range is colour coded to indicate load compatibility. This colour coding concept allows easy selection of the right dimmer for your application.

Load Symbol	Compatible Loads	C-THRU® COLOUR		
		Leading Edge Dimmer 32E450L Series 450W	Trailing Edge Dimmer 32E450T Series 450W	Fan Speed Controller 32E500F Series 500W
	Incandescent lighting Halogen 240V lamps	✓	✓	✗
	Low voltage lighting with iron-core transformers	✓	✗	✗
	Low voltage lighting with electronic transformers	✗	✓	✗
	Exhaust fans (shaded pole induction motors) Ceiling fans (split-phase induction motors)	✗	✗	✓

Recommended C-Thru® Dimmer/ Fan Control Loads

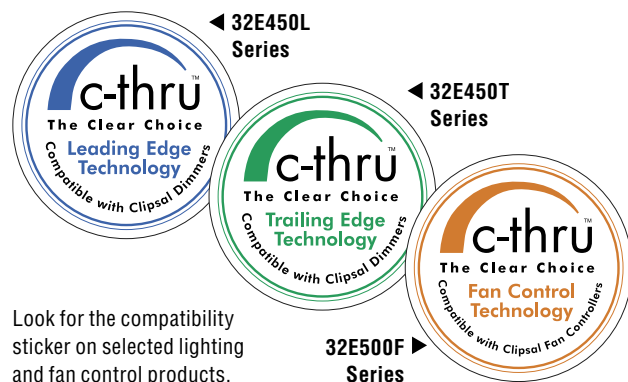

Look for the compatibility sticker on selected lighting and fan control products.

Please note: the colour coding scheme outlined above is the subject of an exclusive Clipsal patent.

DIMMERS, FILTER MODULE & FAN SPEED CONTROLLERS

C-THRU® LIGHT DIMMERS

Cat. No.	Length	Width	Depth	Mounting Centres
32E450L, 32E450T	115mm	73mm	11mm - plate 13mm - knob 30mm - wall recess	84mm apart
32E450LM, 32E450TM	22mm	22mm	13mm - knob 41mm - wall recess	N/A
32E450L	A	C-Thru® Light Dimmer, Leading Edge, 220 - 240V/450W.		
32E450LM	B	C-Thru® Light Dimmer Mechanism, Leading Edge, 220 - 240V/450W.		
32E450T	A	C-Thru® Light Dimmer, Trailing Edge, 220 - 240V/450W.		
32E450TM	B	C-Thru® Light Dimmer Mechanism, Trailing Edge, 220 - 240V/450W.		

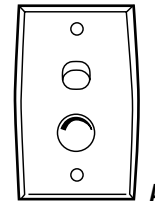

HIGH POWER SERIES LIGHT DIMMERS

Cat. No.	Length	Width	Depth	Mounting Centres
31E800T, 31E1000L	115mm	73mm	15mm - plate 11mm - knob 30mm - wall recess	84mm apart
32/1000, 32/2400	115mm	73mm	11mm - plate 13mm - knob 30mm - wall recess	84mm apart
31E800T	A	Trailing Edge Light Dimmer, 250V/800W, suits incandescent and electronic transformers.		
31E1000L	B	Leading Edge Light Dimmer, 250V/1000W, suits incandescent and iron core transformers.		
32/1000	A	High Power Leading Edge Light Dimmer, 250V/1000VA, remote wired.		
32/2400	B	High Power Leading Edge Light Dimmer, 250V/2400VA, remote wired.		

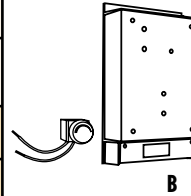
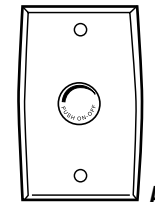

FILTER MODULE

Cat. No.	Length	Width	Depth	Mounting Centres
32EIND	96mm	70mm	48mm	73mm apart
32EIND	A	Inductor Filter Module for use with 32 Series High Powered Dimmers.		

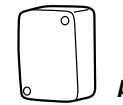

C-Thru® Fan Speed Controller

The C-Thru® Fan Speed Controller unit is rated at 500W (2A), and may be used to provide continuous variable speed control of motor loads such as ceiling sweep fans and exhaust fans.

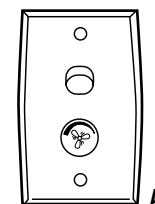

C-THRU® FAN SPEED CONTROLLER

Cat. No.	Length	Width	Depth	Mounting Centres
32E500F	116mm	73mm	11mm - plate 13mm - knob 30mm - wall recess	84mm apart
32E500FM	22mm	22mm	13mm - knob 41mm - mechanism	N/A
32E500F	A	C-Thru® Fan Speed Controller, 220 - 240V/500W - standard size gridplate and surround complete with one 30M switch and one 32E500FM fan control mechanism with knob (suits exhaust fans and ceiling fans).		
32E500FM	B	C-Thru® Fan Controller Mechanism, 220 - 240V/500W (suits exhaust fans and ceiling fans).		

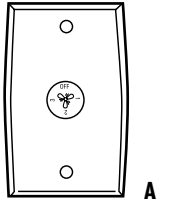

Capacitor Ceiling Sweep Fan Controllers

FAN SPEED CONTROLLER FOR "AIRFLOW" ACES36AL & ACES48AL				
Cat. No.	Length	Width	Depth	Mounting Centres
All Products	115mm	73mm	11mm - plate 14mm - knob 40mm - wall recess	84mm apart
31VF3CA	A	3 Speed Fan Controller, 100VA, suitable for use with Airflow ACES36AL and ACES48AL.		
31VF3CB	A	3 Speed Fan Controller, 100VA, suitable for Airflow ACES56AL and AFLR48.		

This range is available in **White Electric (WE)** only.

Electronic Timer Controls



Time delay switches are a convenient way of saving energy in both domestic and commercial applications such as toilets, bathrooms, stairwells, passageways and other areas that are occupied for a limited or known time, ensuring electrical loads are switched OFF when not in use.

Clipsal offers three types of time delay switches.

The 31VETR is a push-button electronic time delay switch for loads up to 10A. The timer can be set between 15 seconds and 254 minutes. A remote switching function is also included. Another push-button electronic time delay switch is the 31VETR3 which includes remote switching facilities. The time setting can be set from 10 seconds to 15 hours. The 31VETF incorporates two switched outputs and can be used to turn the fan load on at the same time as the light, making it ideal for bathrooms and toilets. When the light is switched off, the fan will remain on for a period of time that can be set from 2 to 20 minutes.

All models have a base projection of 29mm and all terminals accommodate 2 x 2.5mm² cables.

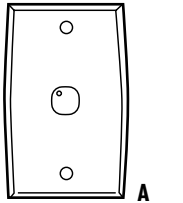
ELECTRONIC TIMER CONTROLS				
Cat. No.	Length	Width	Depth	Mounting Centres
All Products	115mm	73mm	11mm	84mm apart
31VETR	A	Electronic Timer Control, 254 Minute Time Delay, 250V/10A, 2 wire - remote switch input. Neon indicator, load on/neon off/neon off, load on. Delays between 15 secs and 254 mins. Push button to turn load on for set period. Toggle push-button to cancel timer and turn load off. Minimum load is 40mA. Suitable for incandescent or fluorescent lighting.		
31VETR3	A	Electronic Timer Control, 15 Hour Time Delay, 250V/10A, 3 wire - remote switch input. Neon indicator, programmable state. Delays between 10 secs and 15 hours. Push button to turn load on for set period. Toggle push-button to cancel timer. Programmable (NO or NC) output. No minimum load. Suitable for incandescent or fluorescent lighting.		
31VETF	B	Electronic Timer Control, 10 Minutes Time Delay, 250V/10A, Fans/Lights - lights are operated directly off the switch. Lighting load (incandescent only) is 1600VA, fan load is 400VA. Delays between 2 and 20 minutes.		

TIMERS - PNEUMATIC & ANALOGUE

Pneumatic Time Delay Switches

Pneumatic Time Delay switches are robust timers that operate by using air pressure. When the switch is 'pushed in', the load will remain on until the switch 'pops out'. The pneumatic pressure can be set by the installer, allowing time ranges of 2-10 minutes (with care, 20 minutes).

PLEASE NOTE: Rotate the control knob carefully and in very small increments (over tightening will damage the tapered valve).

This time switch operates on the air bleed principle and therefore it is not possible to calibrate it too exactly. The timing will vary slightly with manufacturing tolerances, air temperatures, relative humidity and barometric pressure. Pneumatic Timers are most commonly used in units to operate the lighting in stairwells and other public places such as schools and gymnasiums.

PNEUMATIC TIME DELAY SWITCHES				
Cat. No.	Length	Width	Depth	Mounting Centres
All products	115mm	73mm	11mm	84mm apart
319	A	Time Delay Switch.		
319RA	A	Time Delay Switch, Reverse Action.		
319N	B	Time Delay Switch, with Neon.		
319HP	C	Time Delay Switch, Weatherproof/Hose Proof.		
319X	D	Time Delay Switch, with Extra Switch.		

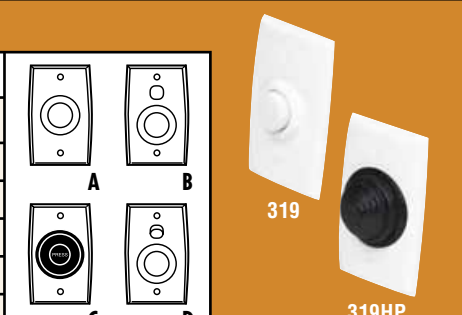

Adjusting Pneumatic Time Delay Switches

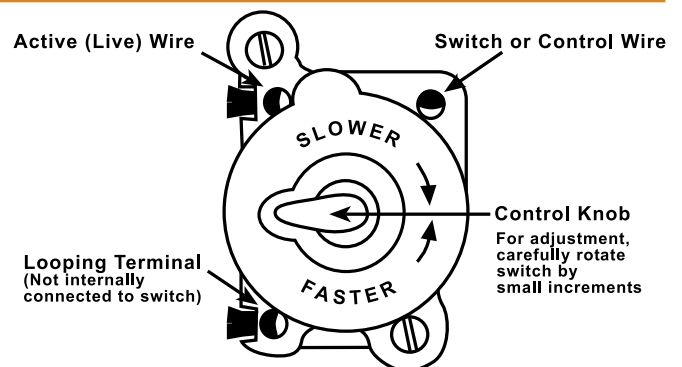

Analogue Timer Controls

Analogue timer controls are available in both switch, socket and portable socket outlet configurations. Connected Loads can be set by the user to turn ON and turn OFF at different times of the day according to the users requirement. Multiple scheduled switching events are supported by all models.

ANALOGUE TIMER CONTROLS				
Cat. No.	Length	Width	Depth	Mounting Centres
TC15/24, TC15/15/24, TC15/15/7D	121mm	79mm	42mm	84mm apart
TC32V1, TC32V24, TC32V7D	115mm	73mm	62mm	84mm apart
TC475/24	160mm	130mm	120mm	N/A
TC15/24	A	24 Hour Timer, single socket outlet, 250V/10A (with safety shutter).		
TC15/15/24	B	24 Hour Timer, single socket outlet, 250V/15A (with safety shutter).		
TC15/15/7D	B	7 Day Timer, single power outlet, 250V/15A (with safety shutter).		
TC32V1	C	1 Hour Timer, flush switch, 250V/15A.		
TC32V24	C	24 Hour Timer, flush switch, 250V/15A.		
TC32V7D	C	7 Day Timer, flush switch, 250V/15A.		
TC475/24	D	24 Hour Timer, portable dual switch socket.		

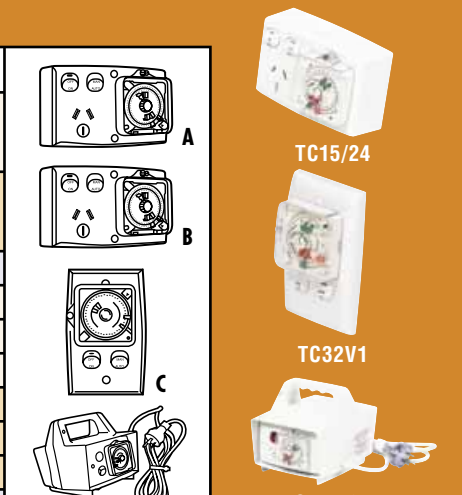

SUNSET SWITCH, BOOSTER ELEMENT RELAYS & SWITCH MULTIPLIERS

Sunset Switches

Sunset Switches cleverly operate lighting in response to the surrounding light levels. Only switching lights on when they are needed, Sunset Switches are convenient and they save money.

The 31VSSR will automatically turn on a connected load when the ambient light level falls below 10 LUX (at around sunset). The load will then turn off the next morning when the light level exceeds 30 LUX. Delays of around 8 seconds for turn off and 30 seconds for turn on take into account any short term changes in light levels that may turn the light on or off.

For more information, check the Clipsal 31VSSR Automatic Sunset Switch brochure O/N 892-912.

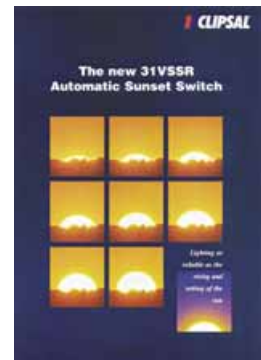

SUNSET SWITCH				
Cat. No.	Length	Width	Depth	Mounting Centres
31VSSR	115mm	74mm	Plate - 13mm Mech - 30mm Box - 37mm	84mm apart
31VSSR	A	Sunset Switch, 250V/10A, 16 hours, 2 wire, IP56 (standard size).		

Please refer to the 56 & 66 Series Industrial brochure, O/N 826-812 for information about the 56SSR & 56PEDD3 Sunset Switches.

Booster Element Relay

The 31VBER is a Booster Relay for a solar hot water element. The relay drops out when the water reaches a certain temperature, returning to solar operation. The push button switch incorporates a neon indicator to illuminate when the Booster Element is operating.

BOOSTER ELEMENT RELAY				
Cat. No.	Length	Width	Depth	Mounting Centres
31VBER	115mm	73mm	Plate - 16mm Button - 4.5mm	84mm apart
31VBER	A	Booster Relay for Solar Hot Water Element, 250V/15A.		

Switch Multipliers

Switch multipliers are used to add additional circuits to existing single circuit installations and also provide two-way switching to an existing single switch installation. They are used instead of wall chasing and running wires down the wall. In this way, they save both time and money.



SWITCH MULTIPLIERS				
Cat. No.	Length	Width	Depth	Mounting Centres
780/1, 780/2, 780K1, 780K2	96mm	70mm	48mm	73mm apart
780/1	A	Switch Multiplier, 250V/10A, 1 way.		
780/2	B	Switch Multiplier, 250V/10A, 2 way.		
780K1	C	Switch Multiplier, 250V/10A, 1 way		
780K2	D	Switch Multiplier, 250V/10A, 2 way.		
780M	E	Switch Multiplier Mechanism, 250V/10A.		
780A2M	F	Switch Multiplier Mechanism, suits 2 loads 2 way type A bias.		
780B2M	F	Switch Multiplier Mechanism, suits 2 loads 2 way type B bias.		

UNDERVOLTAGE RELAYS & KEY TAG TYPE SWITCHES

Under Voltage Relays

Specifically designed to reduce overloads to airconditioners and other sensitive equipment during under voltage (brown-out) situations, the relay switching to open circuit. Excessive loads caused by high in-rush currents when supply is restored are prevented by the manual reset operation requirement, allowing time to full load restoration.

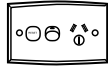
Under Voltage Relays are designed to drop power to the outlet when an under voltage supply condition (or a 'brown-out') occurs.

UNDER VOLTAGE RELAYS					
Cat. No.	Length	Width	Depth	Mounting Centres	
All products	115mm	73mm	11mm	84mm apart	
15X15RZ	A	Single Power Outlet, 250V/15A (with no volt relay and reset switch).			 <p>A</p>  <p>B</p>  <p>C</p>
15XRZ	B	Single Power Outlet, 250V/10A (with no volt relay and reset switch).			
32VRZ	C	No Volt Relay and Reset Switch, 250V/10A, (standard size).			
32VRZ15	C	No Volt Relay and Reset Switch, 250V/15A, (standard size).			



15XRZ



32VRZ

Key Tag type switches and Key Operated Switches

Clipsal's Standard Range Key Tag Switches and Room Access Card Operated Switches are the ideal form of energy management for hotels, motels and other locations where power can be left on unnecessarily.

Inserting the key Tag or card into the switch activates selected circuits to operate lighting, air-conditioning, television, radio and other appliances. Circuits to refrigerators and other equipment that need to continually run are not connected to the switches. Removing the key Tag or card automatically cuts off power to all of the circuits to significantly reduce power wastage.

Refer to adjacent page for detailed information on this range.



KEY TAG & KEY OPERATED SWITCHES

KEY TAG TYPE SWITCHES				
Cat. No.	Length	Width	Depth	Mounting Centres
All Products	115mm	73mm	11mm	84mm apart
36VKT3N	A	Key Tag, suits 3 x 20A, 250V a.c., 1/2way circuit with neon.		
36VKT3NX	B	Key Tag, suits 3 x 20A, 250V a.c., 1/2way circuit, neon, extra 250V a.c. 10A switch.		
36VKT4	A	Key Tag Type Switch, suits 4 x 20A, 250V a.c., 1/2way circuits.		
36VKT4X	B	Key Tag Type Switch, suits 4 x 20A, 250V a.c., 1/2way circuits, extra 10A 250V a.c. switch mech.		

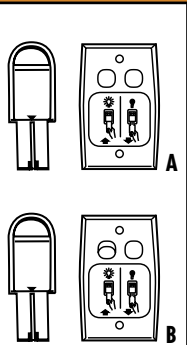





36VK KEY

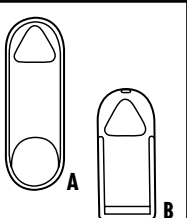

36VK

KEY TAG ONLY				
Cat. No.	Length	Width	Depth	Mounting Centres
35VKT	120mm	45mm	5mm	N/A
2034VKT	92mm	40mm	7mm	N/A
35VKT	A	Key Tag, suits 35VKT series switches.		
2034VKT	B	Short Key Tag, suits 2034VKT series switches.		







35VKT

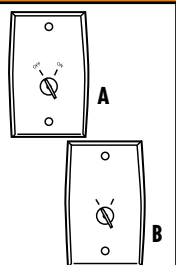

2034VKT

KEY OPERATED SWITCHES				
Cat. No.	Length	Width	Depth	Mounting Centres
All Products	115mm	73mm	*11mm	84mm apart
31VK1	A	Key Operated Switch, 250V 20A/16AX, 1 way (locks in OFF position).		
31VK1/2	B	Key Operated Switch, 250V 20A/16AX, 2 way (locks in OFF position).		
31VK2	A	Key Operated Switch, 250V 20A/16AX, 1 way (locks in ON & OFF position).		
31VK2/2	B	Key Operated Switch, 250V 20A/16AX, 2 way (locks in ON & OFF position).		







31VK1
31VK2

* Depth does not include key height.

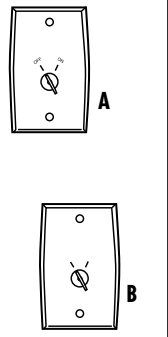
COMMON KEYED SWITCHES				
Cat. No.	Length	Width	Depth	Mounting Centres
All Products	115mm	73mm	*11mm	84mm apart
31VK1CK	A	Key Operated Switch, 250V 20A/16AX, 1 way (locks in OFF position).		
31VK1/2CK	B	Key Operated Switch, 250V 20A/16AX, 2 way (locks in OFF position).		
31VK2CK	A	Key Operated Switch, 250V 20A/16AX, 1 way (locks in ON & OFF position).		
31VK2/2CK	B	Key Operated Switch, 250V 20A/16AX, 2 way (locks in ON & OFF position).		





31VK1/2CK
31VK2/2CK

* Depth does not include key height.



Note: Common key number is 60051.

CEILING & FOOT OPERATED SWITCHES

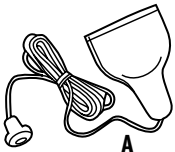
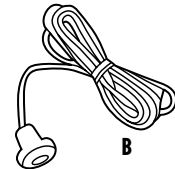

Ceiling Switches

Ceiling switches can be used to operate lights, fans and even hot water boosters. They are convenient in that wires do not have to be run down the wall and they can also be placed in an easier switching position, for example, near a bed.

CEILING SWITCHES				
Cat. No.	Diameter	Depth	Mounting Centres	
306, 342, 343, 346	52mm Ø	71mm	39mm	
306	A	Ceiling Switch, 250V/15A a.c., 1 way (available in Brown - BR, White Electric - WE).		
342	A	Ceiling Switch, 250V/10A a.c., 1 way (available in Brown - BR, White Electric - WE).		
343	A	Ceiling Switch, 250V/10A a.c., 2 way (available in Brown - BR, White Electric - WE).		
346	B	Ceiling Switch Cord in 1.8m lengths (available in White Electric - WE).		

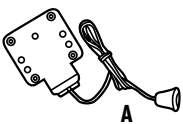

WILCO CEILING SWITCH				
Cat. No.	Length	Width	Depth	Mounting Centres
PC1	57mm	45mm	18mm	30mm x 28mm
PC1	A	Ceiling Switch, Pull Cord, 10A, double pole with indicator (available in White Electric - WE).		

Foot Operated Switch

The 360 foot operated switch is very handy when installed under desks to operate heaters, lighting or fans. It can also be placed in other convenient positions when 'foot switching' is preferred.

FOOT OPERATED SWITCH				
Cat. No.	Length	Width	Depth	Mounting Centres
360	93mm	55mm	29mm	68 x 18mm apart
360	A	Foot Switch, 250V/10A, double pole.		

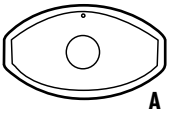
* Please note:- For Mounting Accessory suggestions, refer to your Clipsal Representative.

AMERICAN STYLE FLUSH SWITCHES & PLATES

AMERICAN STYLE FLUSH SWITCHES AND PLATES - INDIRECT MOUNTING				
Cat. No.	Length	Width	Depth	Mounting Centres
321,321R	115mm	70mm	8mm	60mm apart
322/1R	116mm	116mm	8mm	60 x 46mm
320,320/15	93mm	35mm	35mm	84mm apart
DC3, DC3-SPDT	93mm	35mm	36mm	84mm apart
WSW110, WSW110/TW, WSW116, WSW116/TW	93mm	35mm	32mm	84mm apart
FS169/I, FS169/15DPDT	93mm	35mm	22mm	84mm apart
321	A	1 Gang Switch Plate (available in White Electric - WE).		
321R	B	Switch Plate , suits one x 405 or 415 series socket (available in Brown - BR, Soft Grey - SG, Grey - GY, White Electric - WE).		
322/1R	C	Switch Plate , suits one x 320 series switch and 1 x 405 or 415 series socket (available in Brown - BR, White Electric - WE).		
320	D	Switch Mechanism , 250V a.c./10A, 1 way (available in Brown - BR, Grey - GY, White Electric - WE).		
320/15	D	Switch Mechanism , 250V a.c./15A, 1 way (available in Brown - BR, White Electric - WE).		
DC3	E	Flush Switch , 5A, 3 terminal, 1 way, DC, with mounting lugs (available in Brown - BR).		
DC3-SPDT	E	Flush Switch , 5A, 3 terminal, single pole/double throw, DC, with mounting lugs (available in Brown - BR).		
WSW110	F	Flush Switch , 10A, 1 way (available in Brown - BR, Grey - GY, White Electric - WE).		
WSW110/TW	G	Flush Switch , 10A, 2 way (available in Brown - BR, Grey - GY, White Electric - WE).		
WSW116	F	Flush Switch , 15A, 1 way (Brown - BR, Grey - GY, White Electric - WE).		
WSW116/TW	G	Flush Switch , 16A, 2 way (Grey - GY).		
FS169/I	H	Flush Switch , 10A, intermediate, with mounting lugs (available in Grey - GY).		
FS169/15DPDT	I	Flush Switch , 15A, intermediate, double pole/double throw, with mounting lugs (available in Grey - GY).		

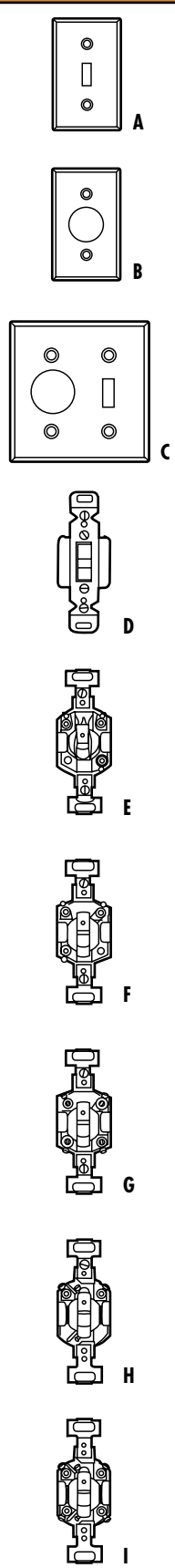

* Please note:- For Mounting Accessory suggestions, refer to your Clipsal Representative.

SURFACE & PUSH BUTTON SWITCHES

Surface switches are traditional switches that existed before the introduction of the 30 Series mechanism. They are an economical alternative to the Heritage Range if a traditional look is preferred.

WILCO SURFACE SWITCH

Cat. No.	Diameter	Depth	Mounting Centres
SS165/15/2	52mm Ø	17mm	36mm
SS165/15/2	A	Surface Switch, 15A, 2 way, 3 terminal, screw secured cover, 52mm diameter (available in Brown - BR, White Electric - WE).	

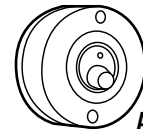

SS165/15/2

SURFACE SWITCHES

Cat. No.	Diameter	Depth	Mounting Centres
362, 362/15, 363	60mm Ø	19mm	48mm apart
389	61mm Ø	27mm	43mm apart
362	A	Surface Switch, 250V/10A, 1 way, 3 terminal (available in Brown - BR, White Electric - WE).	
362/15	A	Surface Switch, 250V/15A, 1 way, 3 terminal (available in Black - BK, Brown - BR, White Electric - WE).	
363	A	Surface Switch, 250V/10A, 2 way, 4 terminal (available in Black - BK, Brown - BR, White Electric - WE).	
389	B	Surface Switch, 250V/25A a.c., 32V d.c., 1 way (available in Black - BK, White Electric - WE).	

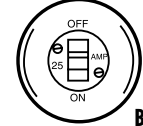
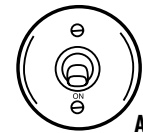

362,
362/15,
363

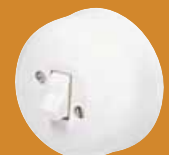

389

BELL PRESS

Cat. No.	Length	Width	Depth	Mounting Centres
98	60mm	25mm	19mm	48mm apart
98	A	Bell Press, Illuminated (available in Brown - BR, White Electric - WE).		

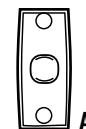

98

WILCO PUSH BUTTON SWITCHES

Cat. No.	Length	Width	Depth	Mounting Centres
PBS136	28mm	15mm	28mm (Room protrusion - 18mm)	N/A
PBS236	28mm	15mm	34mm (Room protrusion - 18mm)	N/A
PBS136	A	Push Button Mechanism with Collar and Locknut, 2A, single pole (available in White Electric - WE).		
PBS236	B	Push Button Mechanism with Collar and Locknut, 2A, double pole (available in WE).		

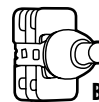
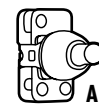

PBS136



PBS236

PUSH BUTTON WEATHERPROTECTED 1P53 SURFACE SWITCHES

Cat. No.	Length	Width	Depth	Mounting Centres
All products	60mm	35mm	32mm	67mm x 54mm
WPBSW110	A	1 Gang Push Button Surface Switch, 10A, 1 way/2 way, single pole.		
WPBSW116	A	1 Gang Push Button Surface Switch, 16A, 1 way/2 way, single pole.		



WPBSW110,
WPBSW116

* Please note:- For Mounting Accessory suggestions, refer to your Clipsal Representative.

Circuit Identification Products

Clipsal offers a range of Circuit Identification products to make your job easier.

CIRCUIT IDENTIFICATION PRODUCTS				
Cat. No.	Length	Width	Depth	Mounting Centres
30P, 30PFO	21mm	21mm	10mm	
30PID	21mm	21mm	7mm	
30P	A	Removable Blank Plug, suits 30 Series.		
30PFO	B	Plug, marked "FRIDGE - FREEZER ONLY".		
30PID	C	30 Series ID Circuit Plug, tamper proof.		
30PIDA4L*	D	Label Sheets, 10 x A4 packet (RD, BU, GR, YL, WE colours available).		
9	E	Cap, suits switch plate screw recesses.		
9SERIES	E	Identi-Caps for Circuit Identification.		

*Software for printing these Label Sheets are available on the Alfred CD-ROM Electronic Trade Product Guide.

Mounting Accessories

Mounting Accessories are for use when mounting 30 Series mechanisms without a flush plate, for example, in a panel or enclosure.

MOUNTING ACCESSORIES				
Cat. No.	Length	Width	Depth	Mounting Centres
ET30	6mm	N/A	N/A	N/A
B30GFZ	45mm	27mm	11mm	24mm apart
F30Z1, F30Z1.5 F30Z2, F30Z4	29mm	29mm	N/A	N/A
31/3F	167mm	116mm	11mm	92mm apart
ET30	A	Screw Mounted Earthing Terminal.		
B30GFZ	B	Mounting Clip with Moulded Surround.		
F30Z1	C	Mounting Clip Mechanism, suits 1mm thick sheet.		
F30Z1.5	C	Mounting Clip Mechanism, suits 1.5mm thick sheet.		
F30Z2	C	Mounting Clip Mechanism, suits 2mm thick sheet.		
F30Z4	C	Mounting Clip Mechanism, suits 4mm thick sheet.		
31/3F	D	Three Gang Mounting Flange.		

CABLE CONNECTION ACCESSORIES

Cable Connection Accessories

Cable Connection Accessories are used for safety and to anchor cables.

CABLE CONNECTION ACCESSORIES				
Cat. No.	Length	Width	Depth	Mounting Centres
31VXCB	115mm	73mm	11mm	84mm apart
32VA15/38TB	115mm	73mm	11mm	84mm apart
38, 38A, 38X, 38Y*, 38Z	22mm Ø		TBA	N/A
38HD	25mm	21mm	30mm	N/A
38TB	32mm	22mm		N/A
31VXCB	A	Blank Plate with 30A Connector Block.		
32VA15/38TB	B	30M15 Mech and 38TB Terminal Block, in standard size plate.		
38	C	Grommet, suits up to 2.5mm ² ordinary duty flex cord.		
38A	C	Grommet, suits up to 1.5mm ² ordinary duty flex cord.		
38X	C	Grommet, suits up to 1mm ² ordinary duty flex cord.		
38Y*	D	Grommet, suits figure 8 two core flex cord, outer diameter of the figure 8 core cable is maximum 3mm (each core).		
30Z	C	Grommet, suits up to 0.75mm ² light duty flex cord.		
38HD	E	Grommet, suits up to 2.5mm ² ordinary duty with clamp.		
38TB	F	Cord Outlet Terminal Block with Grommet, suits 30 series plates.		

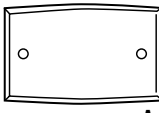

A

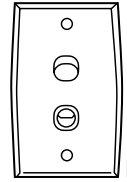

B

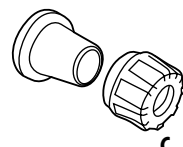

C

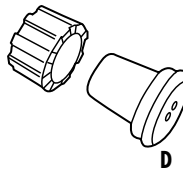

D

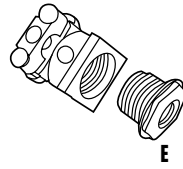

E



F



31VXCB



32VA15/38TB



38



38Y



38HD





38TB

* 38Y Grommet requires an 18mm hole for installation.

PROTECTED SWITCHES

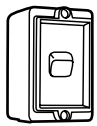
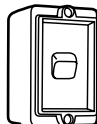
PROTECTED SWITCHES - MOULDED

Cat. No.	Length	Width	Depth	Mounting Centres	
PSM110	75mm	46mm	51mm	69mm apart	 A
PSM115	75mm	46mm	51mm	69mm apart	
PSM110	A	Protected Switch, 250V/10A, 1 way/2 way.			 B
PSM115	B	Protected Switch, 250V/15A, 1 way/2 way.			



PSM110

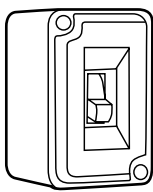
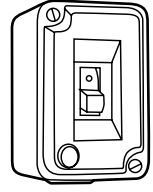
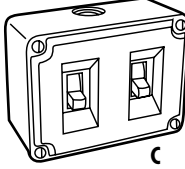

PSM115

PROTECTED SWITCHES - 250V, 10A, ZINC DIE CAST

Cat. No.	Length	Width	Depth	Mounting Centres	
PS110, PS110-DC, PS110-DP, PS110-I, PS110-N, PS110-TW	79mm	51mm	50mm	37mm apart	 A
PS110-2, PS110-2DP, PS110-2I	101mm	79mm	50mm	82mm apart	
PS110	A	Single pole.			 B
PS110-DC	A	Single pole, DC operation.			
PS110-DP	A	Double pole.			
PS110-I	A	Single pole, intermediate.			
PS110-N	B	Single pole, with neon.			 C
PS110-TW	A	Single pole, 2 way.			
PS110-2	C	Single pole, two gang.			
PS110-2DP	C	Double pole, two gang.			
PS110-2I	C	Single pole, two gang, intermediate.			



PS110

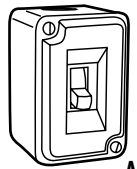
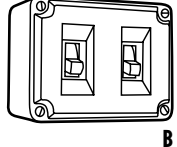

PS110-N

PS110-2

PROTECTED SWITCHES - 250V, 16A, ZINC DIE CAST

Cat. No.	Length	Width	Depth	Mounting Centres	
PS116, PS116/TW	80mm	51mm	50mm	38mm apart	 A
PS116/2	101mm	80mm	50mm	82mm apart	
PS116	A	Single pole.			 B
PS116/TW	A	Single pole, two gang.			
PS116/2	B	Single pole, 2 way.			

PS116

PS116-2

SOCKET OUTLETS

SOCKET OUTLETS



AUTOMATICALLY SWITCHED SOCKET OUTLETS

Automatically switched socket outlets are most commonly used to supply power to computers, refrigerators, microwaves and other accessories that don't need to be switched off at the socket. Simply inserting the plug into the outlet provides power to equipment. Removing the plug opens the contacts in the socket to provide the same level of safety as a conventional switched socket when switched off.

Automatically switched socket outlets are also advantageous in that an appliance which is plugged into it can be switched on or off from a more convenient location, saving time and effort for more valuable activities.

Available in the Standard Range are single and double automatically switched socket outlets, with a weatherproof version (ideal for caravans) and a product with a security flap.

The socket outlets are manufactured in accordance with AS/NZ 3100, AS/NZ 3112, AS/NZ 3133 and other relevant Standards Australia Approval and Testing Specifications, Wiring Rules and Supply Authority requirements.

STANDARD SIZE SINGLE AUTOMATICALLY SWITCHED SOCKET OUTLETS				
Cat. No.	Length	Width	Depth	Mounting Centres
10, 10D, 10DS, 10DN, 10DLS, 10D15S	115mm	73mm	16mm	84mm apart
10DWP, 10DWP15,	93mm	82mm	12mm	70 x 54mm
415VF, 415VF15	101mm	80mm	37mm	76 x 65mm
10PL	115mm	73mm	22mm	84mm apart
10	A	Single Auto Switched Socket Outlet, 10A, single pole, horizontal mount.		
10D	A	Single Auto Switched Socket Outlet, 10A, double pole, horizontal mount.		
10DS	A	Single Auto Switched Socket Outlet, 10A, double pole with safety shutters, horizontal mount.		
10DN	B	Single Auto Switched Socket Outlet, 10A, double pole with safety shutters and neon, horizontal mount.		
10DLS	C	Single Auto Switched Socket Outlet, 10A, round earth, double pole with safety shutters, horizontal mount.		
10D15S	D	Single Auto Switched Socket Outlet, 15A, double pole with safety shutters, horizontal mount.		
*10DWP	E	Single Auto Switched Socket Outlet, 10A, double pole flush weatherproof with flap. <i>*Will be superseded by 415VF</i>		
*10DWP15	F	Single Auto Switched Socket Outlet, 15A, double pole flush weatherproof with flap. <i>*Will be superseded by 415VF15</i>		
415VF	G	Single Auto Switched Socket Outlet, 10A, double pole with flap, IP34 rating.		
415VF15	H	Single Auto Switched Socket Outlet, 15A, double pole with flap, IP34 rating.		
10PL	I	Single Auto Switched Socket Outlet, 10A, single pole with security flap, horizontal mount.		

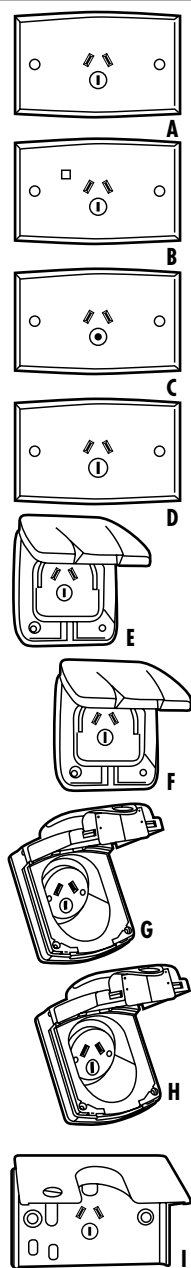

AUTOMATICALLY SWITCHED SOCKET OUTLETS (Continued)

STANDARD SIZE TWIN AUTOMATICALLY SWITCHED SOCKET OUTLETS - HORIZONTALLY MOUNTED

Cat. No.	Length	Width	Depth	Mounting Centres
All products	115mm	73mm	16mm	84mm apart
20	A	Twin Auto Switched Socket Outlet, 10A, single pole.		
20D	A	Twin Auto Switched Socket Outlet, 10A, double pole.		
20DS	A	Twin Auto Switched Socket Outlet, 10A, double pole with safety shutters.		
20DN	B	Twin Auto Switched Socket Outlet, 10A, double pole with safety shutters and neons.		
20DLS	C	Twin Auto Switched Socket Outlet, 10A, round earth, double pole and safety shutters.		

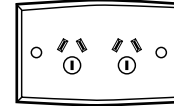

A

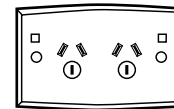

B

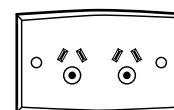

C



20



20DN



20DLS

SKIRTING MOUNTED SINGLE AUTOMATICALLY SWITCHED SOCKET OUTLET

Cat. No.	Length	Width	Depth	Mounting Centres
11	95mm	45mm	17mm	78mm apart
11	A	Single Auto Switched Socket Outlet, skirting mounted, 10A, single pole (95 x 45mm at centre).		

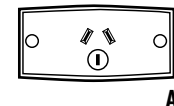

A



11

SKIRTING MOUNTED TWIN AUTOMATICALLY SWITCHED SOCKET OUTLETS

Cat. No.	Length	Width	Depth	Mounting Centres
11/2	125mm	50mm	17mm	104mm apart
11/2MF 11/2MFN	156mm	45mm	18mm	136mm apart
11/2	A	Twin Auto Switched Socket Outlet, skirting mounted, 10A, single pole (125 x 50mm at centre).		
11/2MF	B	Twin Auto Switched Socket Outlet, skirting mounted, 10A, single pole, suits ducting (156 x 45mm at centre).		
11/2MFN	C	Twin Auto Switched Socket Outlet, skirting mounted, 10A, single pole, safety shutters, neons, suits ducting (156 x 45mm at centre).		

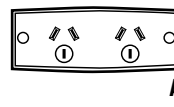

A

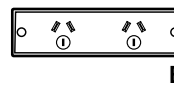

B

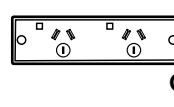

C



11/2



11/2MF



11/2MFN

AUTOMATICALLY AND SPECIAL PURPOSE SWITCHED SOCKET OUTLETS



AUTOMATICALLY SWITCHED SOCKET OUTLETS

Cat. No.	Length	Width	Depth	Mounting Centres
All products	97mm	43mm	29mm	84mm apart
10M	A	Single Auto Switched Socket Outlet Mechanism, 10A, single pole (available in Brown - BR, Grey - GR, White Electric - WE).		
10MD	A	Single Auto Switched Socket Outlet Mechanism, 10A, double pole (available in Brown - BR, Grey - GR, White Electric - WE).		
10MDS	A	Single Auto Switched Socket Outlet Mechanism, 10A, double pole with safety shutter (available in Brown - BR, White Electric - WE).		
10MDLS	B	Single Auto Switched Socket Outlet Mechanism, 10A, round earth, double pole with safety shutter (available in White Electric - WE).		
10MD15S	C	Single Auto Switched Socket Outlet Mechanism, 15A, double pole with safety shutter (available in White Electric - WE).		
10MD20	D	Single Auto Switched Socket Outlet Mechanism, 20A, double pole (available in White Electric - WE).		

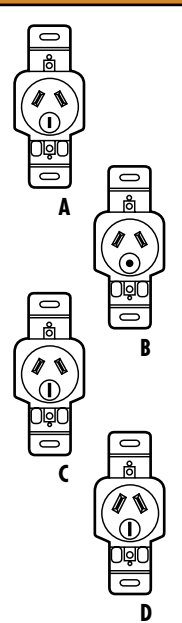

SPECIAL PURPOSE AUTOMATICALLY SWITCHED SOCKET OUTLETS

Cat. No.	Length	Width	Depth	Mounting Centres
10MP	43mm	42mm	33mm (Room protrusion - 3.5mm)	See mounting detail Pg. 38
10MDP, 10MDPL, 10MDP15	43mm	42mm	33mm (Room protrusion - 3.5mm)	See mounting detail Pg. 38
10MP	A	Single Auto Switched Socket Outlet Mechanism, 10A, single pole, panel mount (available in Brown - BR, Grey - GY, White Electric - WE). Fascia - 42mm Ø.		
10MDP	B	Single Auto Switched Socket Outlet Mechanism, 10A, double pole, panel mount (available in Brown - BR, Grey - GY, White Electric - WE). Fascia - 42mm Ø.		
10MDPL	C	Single Auto Switched Socket Outlet Mechanism, 10A, round earth, double pole, panel mount (available in Brown - BR, Grey - GY, White Electric - WE). Fascia - 42mm Ø.		
10MDP15	D	Single Auto Switched Socket Outlet Mechanism, 15A, double pole, panel mount (available in Brown - BR, Grey - GY, White Electric - WE). Fascia - 42mm Ø.		

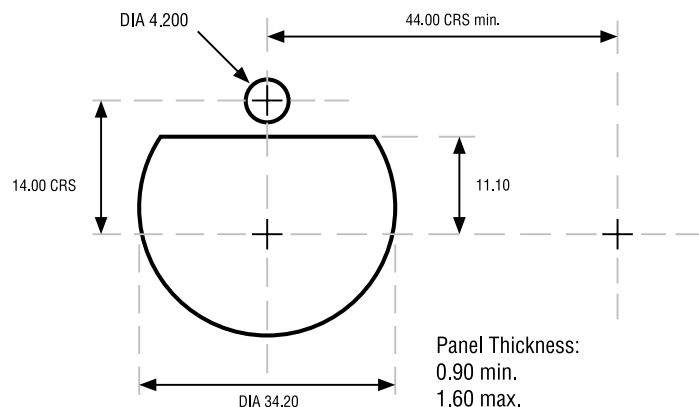
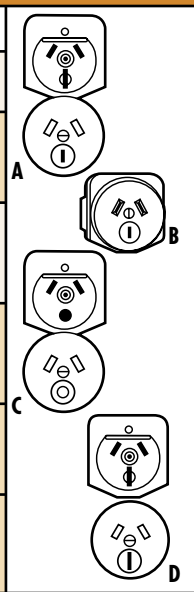

415MP and 10MP Panel Mount Detail

AUTOMATICALLY AND SPECIAL PURPOSE SWITCHED SOCKET OUTLETS

SPECIAL PURPOSE AUTOMATICALLY SWITCHED SOCKET OUTLETS (Continued)



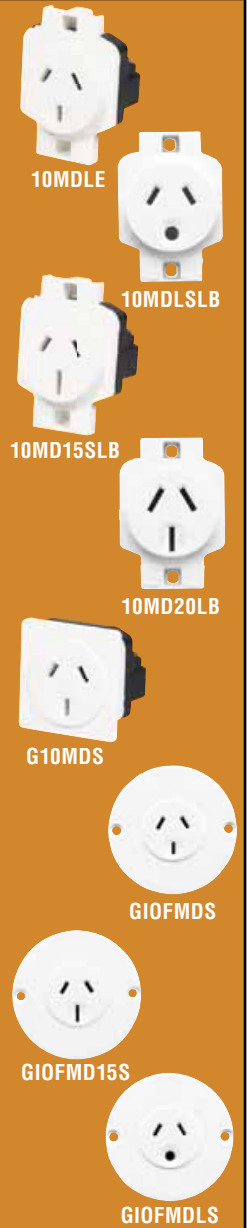
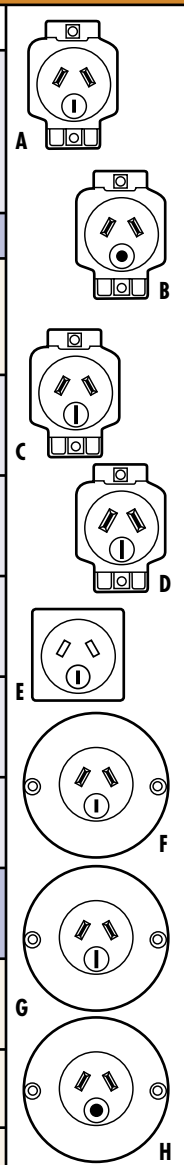

SPECIAL PURPOSE AUTOMATICALLY SWITCHED SOCKET OUTLETS

Cat. No.	Length	Width	Depth	Mounting Centres
10MDLB, 10MDSLb, 10MDLSLB, 10MD15SLB, 10MD20LB	60mm	42mm	33mm	50mm apart
G10MDS	46mm	46mm	34mm	N/A
G10FMDS, G10FMD15S, G10FMDLS	74mm Ø		31mm	64mm apart
10MDLB	A	Single Auto Switched Socket Outlet Mechanism, 10A, double pole, less bracket (available in Grey - GY, Soft Grey - SG, White Electric - WE).		
10MDSLb	A	Single Auto Switched Socket Outlet Mechanism, 10A, double pole with safety shutter, less bracket (available in Grey - GY, White Electric - WE).		
10MDLSLB	B	Single Auto Switched Socket Outlet Mechanism, 10A, round earth, double pole, safety shutter, less bracket (available in White Electric - WE).		
10MD15SLB	C	Single Auto Switched Socket Outlet Mechanism, 15A, double pole with safety shutter, less bracket (available in White Electric - WE).		
10MD20LB	D	Single Auto Switched Socket Outlet Mechanism, 20A, double pole, less brackets (available in White Electric - WE).		
G10MDS	E	GEC Miniplug Mechanism, 10A, double pole with safety shutter (available in Grey - GY, White Electric - WE).		
G10FMDS	F	GEC AF Series Mechanism, 10A, double pole with safety shutter (available in Grey - GY, White Electric - WE).		
G10FMD15S	G	GEC AF Series Mechanism, 15A, double pole with safety shutter (available in White Electric - WE).		
G10FMDLS	H	GEC AF Series Mechanism, 10A, round earth with safety shutter (available in White Electric - WE).		

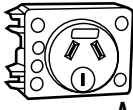

SKIRTING MOUNTED & TOGGLE SWITCHED SOCKET OUTLETS

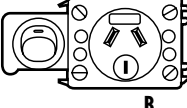
SKIRTING MOUNTED SIDE CONNECTING SOCKET OUTLETS

Cat. No.	Length	Width	Depth	Mounting Centres		
12M	63mm	43mm	29mm	N/A	 A	 12M
17M	90mm	43mm	29mm	N/A		
12M	A	Single Auto Switched Socket Outlet , skirting mounted, side connecting 250V/10A, single pole (available in Black - BK, Grey - GY, Red - RD, Soft Grey - SG, White Electric - WE).			 B	 17M
17M	B	Single Switched Socket Outlet , skirting mounted, side connecting, 250V/10A, single pole (available in Beige - BG, Black - BK, Brown - BR, Grey - GY, Red - RD, Soft Grey - SG, White Electric - WE).				

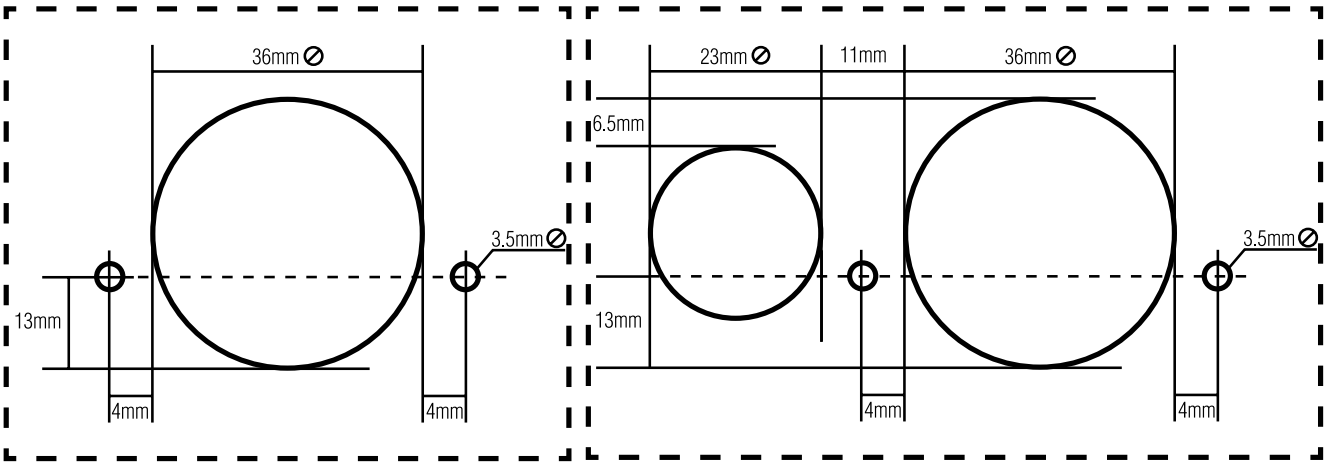

12M Cutout Template





17M Cutout Template

Screws must be at least 15mm long with countersunk heads and fastened with nuts (for both 12M & 17M)

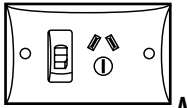

Toggle Switched Socket Outlets

Toggle switched socket outlets are a foundation product for Clipsal, as they have been around before the 30 Series mechanism was introduced. They operate similarly to the 30 Series mechanism, however they have a switch design which is more traditional.

STANDARD SIZE SINGLE TOGGLE SWITCHED SOCKET OUTLETS - HORIZONTALLY MOUNTED

Cat. No.	Length	Width	Depth	Mounting Centres		
All products	115mm	70mm	15mm	84mm apart	 A	 42/20
42/20	A	Single Switched Socket Outlet , toggle switch, 250V/20A, single pole.				
42/20N	B	Single Switched Socket Outlet , toggle switch, 250V/20A, single pole with safety shutter and neon.			 B	 42/20N

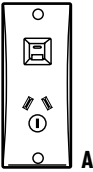
SINGLE TOGGLE NARROW ARCHITRAVE SIZE SWITCHED SOCKET OUTLETS - VERTICALLY MOUNTED

Cat. No.	Length	Width	Depth	Mounting Centres		
All products	115mm	48mm	15mm	98mm apart	 A	 40
40	A	Single Switched Socket Outlet , toggle switch, 250V/10A, single pole (115 x 48mm at centre).				
40D	A	Single Switched Socket Outlet , toggle switch, 250V/10A, double pole (115 x 48mm at centre).				

UNSWITCHED SOCKET OUTLETS

Unswitched Socket Outlets

Unswitched Socket Outlets are reliable products which have a strong history. They are usually mounted flush against panels or enclosures and are specialised, in that most Unswitched Socket Outlets are not available in Standard Range flush plates.

UNSWITCHED SOCKET OUTLETS				
Cat. No.	Length	Width	Depth	Mounting Centres
405, 405/32, 415, 415L, 415/110, 415/15	96mm	42mm	33mm (Room protrusion of 3.5mm)	84mm apart
415MP, 415MP15, 415MPL	43mm	42mm	33mm (Room protrusion of 3.5mm)	See mounting detail Pg. 38
426, 426L, 426/15	66mm Ø		24mm	50mm apart
405	A	Single Auto Switched Socket Outlet, 250V/10A, 2 pin parallel (available in Brown - BR, Grey - GY, White Electric - WE). Fascia - 42mm Ø.		
405/32	B	Single Auto Switched Socket Outlet, 32V/15A, 2 pin polarised, extra low voltage (available in Brown - BR, Grey - GY, White Electric - WE). Fascia - 42mm Ø.		
415	C	Single Auto Switched Socket Outlet, 250V/10A, 3 pin (available in Brown - BR, Grey - GY, White Electric - WE). 42mm Ø fascia.		
415L	D	Single Auto Switched Socket Outlet, 250V/10A, 3 pin, round earth pin (available in Brown - BR, Grey - GY, White Electric - WE). Fascia - 42mm Ø.		
415/110	E	Single Auto Switched Socket Outlet, 110V/10A, 3 pin, 2 round live pins (available in Black - BK, Brown - BR, Grey - GY, White Electric - WE). Fascia - 42mm Ø.		
415/15	F	Single Auto Switched Socket Outlet, 250V/15A, 3 pin, (available in Brown - BR, Grey - GY, White Electric - WE). Fascia - 42mm Ø.		
415MP	G	Single Auto Switched Socket Outlet, 250V/10A, 3 pin, panel mount (available in Black -BK, White Electric - WE). Fascia - 42mm Ø.		
415MP15	H	Single Auto Switched Socket Outlet, 250V/15A, 3 pin, panel mount (available in Black -BK, White Electric - WE). Fascia - 42mm Ø.		
415MPL	I	Single Auto Switched Socket Outlet, 250V/10A, 3 pin, round earth, panel mount (available in Black -BK, White Electric - WE). Fascia - 42mm Ø.		
426	J	Single Auto Switched Socket Outlet, 250V/10A, 3 pin, suits round J-Box (available in Brown - BR, Grey - GY, White Electric - WE).		
426L	K	Single Auto Switched Socket Outlet, 250V/10A, 3 pin, round earth pin, suits round J-Box (available in Brown - BR, Grey - GY, White Electric - WE).		
426/15	L	Single Auto Switched Socket Outlet, 32V/15A, 3 pin, suits round J-Box (available in White Electric - WE).		

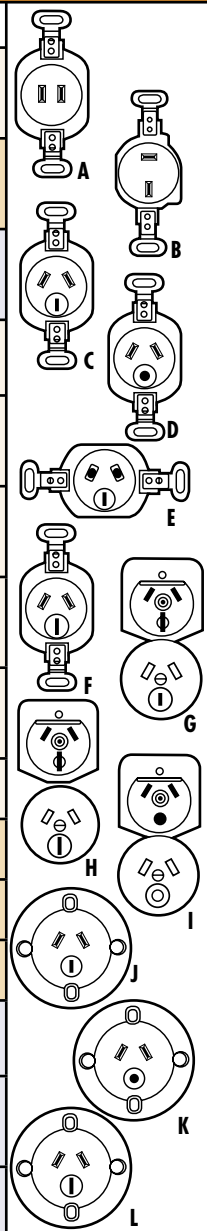

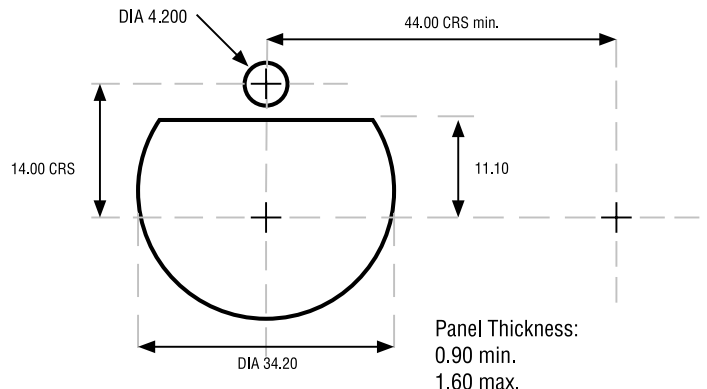

* Please note:- For Mounting Accessory suggestions, refer to your Clipsal Representative.



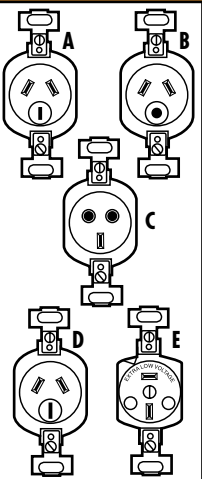

415MP and 10MP Panel Mount Detail

WILCO SOCKET OUTLETS (GREY ONLY)				
Cat. No.	Length	Width	Depth	Mounting Centres
All products	96mm	42mm	28mm	84mm apart
FOS106	A	Single Automatically Switched Socket Outlet, 250V/10A, 3 flat pins.		
FOS106R	B	Single Automatically Switched Socket Outlet, 250V/10A, 3 pin, round earth pin.		
FOS106/2R	C	Single Automatically Switched Socket Outlet, 110V/10A, 3 pin, 2 round live pins.		
FOS106/15	D	Single Automatically Switched Socket Outlet, 250V/15A, 3 flat pins.		
FOS105T	E	Single Automatically Switched Socket Outlet, 2 flat polarised, extra low voltage.		

All models available less lugs (add 'LL' to cat. no.).
 All models are available in Grey - GY only.

ELECTRIC CLOCK CONNECTION ACCESSORIES				
Cat. No.	Length	Width	Depth	Mounting Centres
408/3, 408/3A, 408/4	106mm	59mm	25mm	84mm apart
409/3, 409/3A, 409/4	48mm	16.5mm	N/A	
408/3	A	Clock Point Recessed Socket, 250V/5A, 50Hz, 3 pin.		
408/3A	B	Clock Point Recessed Socket, 3 pin, suitable for other than 250V/50Hz.		
408/4	C	Clock Point Recessed Socket, 250V/15A, 4 pin.		
409/3	D	Clock Point Plug, 250V/5A, 50Hz, 3 pin.		
409/3A	E	Clock Point Plug, 3 pin, suitable for other than 250V/50Hz.		
409/4	F	Clock Point Plug, 250V/5A, 50Hz, 4 pin.		

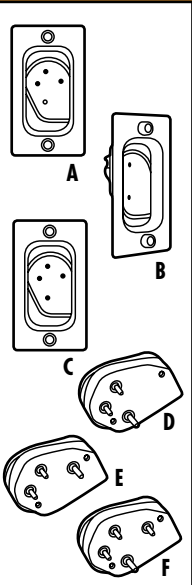
* Please note:- For Mounting Accessory suggestions, refer to your Clipsal Representative.



SWITCHED SOCKET OUTLETS

SWITCHED SOCKET OUTLETS



The Standard Range offers a huge variety of Switched Socket Outlets. Available in 10 and 15A ratings, vertical and horizontal formats, they also come with a number of options such as neons, extra switches and safety shutters, not to mention two-piece base versions and more. Also available are large format, intermediate and skirting mounted versions.

All terminal screws face the same direction and are backed off for easy cable insertion. Socket terminal bores are 5.5mm.

Switched Socket Outlets are manufactured in accordance with AS/NZ 3100, AS/NZ 3112, AS/NZ 3133 and other relevant Australian and New Zealand Standards, and comply with all relevant Wiring Rules and Electrical Authorities' requirements.

Double Pole Switched Socket Outlets

The safety features of double pole switched sockets has led to them becoming an integral part of electrical accessories in recent times. Standard Range double pole switched socket outlets enable marine craft, caravan and mobile home manufacturers to install double pole switched sockets in their boats, vans and homes to comply with AS/NZS3000 requirements.

STANDARD SIZE SINGLE SWITCHED SOCKET OUTLETS - HORIZONTALLY MOUNTED				
Cat. No.	Length	Width	Depth	Mounting Centres
15 Series	115mm	73mm	14mm	84mm apart
15DD Series	115mm	73mm	33mm	84mm apart
15	A	Single Switched Socket Outlet, 250V/10A.		
15S	A	Single Switched Socket Outlet, 250V/10A, with safety shutter.		
15N	B	Single Switched Socket Outlet, 250V/10A, with safety shutter and neon.		
15D	A	Single Switched Socket Outlet, 250V/10A, double pole.		
15D15	C	Single Switched Socket Outlet, 250V/15A, double pole.		
15DN	B	Single Switched Socket Outlet, 250V/10A, double pole with safety shutter and neon.		
15DD	D	Single Switched Socket Outlet, 250V/10A, double pole, deep plate.		
15DDN	E	Single Switched Socket Outlet, 250V/10A, double pole, deep plate, safety shutter and neon.		
15DX	F	Single Switched Socket Outlet, 250V/10A, double pole with removable extra switch.		
15/15	G	Single Switched Socket Outlet, 250V/15A.		
15/15S	G	Single Switched Socket Outlet, 250V/15A, with safety shutter.		
15/15N	H	Single Switched Socket Outlet, 250V/15A, with safety shutter and neon.		
15L	I	Single Switched Socket Outlet, 250V/10A, round earth pin.		
15LN	J	Single Switched Socket Outlet, 250V/10A, round earth pin, neon and safety shutter.		
15X	K	Single Switched Socket Outlet, 250V/10A, with removable extra switch.		
15XS	K	Single Switched Socket Outlet, 250V/10A, with removable extra switch and safety shutter.		
15XN	L	Single Switched Socket Outlet, 250V/10A, with removable extra switch, neon and safety shutter.		
15XX	M	Single Switched Socket Outlet, 250V/10A, with two removable extra switches.		

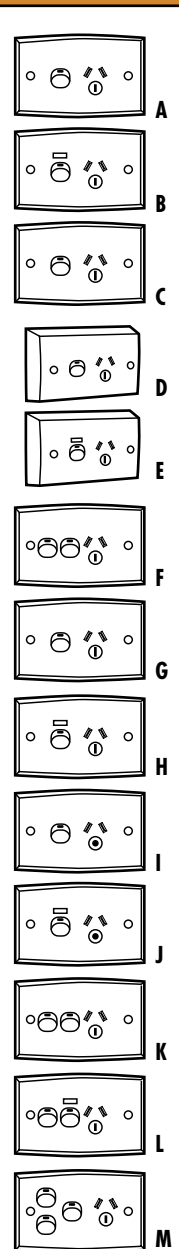

TWIN SWITCHED SOCKET OUTLETS- HORIZONTALLY MOUNTED

STANDARD SIZE TWIN SWITCHED SOCKET OUTLETS - HORIZONTALLY MOUNTED

Cat. No.	Length	Width	Depth	Mounting Centres
All products	115mm	73mm	16mm	84mm apart
25	A	Twin Switched Socket Outlet, 250V/10A.		
25S	A	Twin Switched Socket Outlet, 250V/10A with safety shutters.		
25N	D	Twin Switched Socket Outlet, 250V/10A with neons and safety shutters.		
25D	B	Twin Switched Socket Outlet, 250V/10A, double pole.		
25D15	C	Twin Switched Socket Outlet, 250V/15A, double pole.		
25/15	E	Twin Switched Socket Outlet, 250V/15A.		
25/15S	E	Twin Switched Socket Outlet, 250V/15A, with safety shutters.		
25/15N	F	Twin Switched Socket Outlet, 250V/15A, with neons and safety shutters.		
25/1510	G	Twin Switched Socket Outlet, 250V/15A and 10A.		
25L	H	Twin Switched Socket Outlet, 250V/10A, round earth pin.		
25X	I	Twin Switched Socket Outlet, 250V/10A with extra one way switch.		
25XS	I	Twin Switched Socket Outlet, 250V/10A, extra one way switch and safety shutters.		
MF25X	J	Twin Switched Socket Outlet, 250V/10A, marked with "FAN" on extra switch.		
ML25X	K	Twin Switched Socket Outlet, 250V/10A, marked with "LIGHT" on extra switch.		
25XA	L	Twin Switched Socket Outlet, 250V/10A with removable extra switch.		
25XAN	M	Twin Switched Socket Outlet, 250V/10A, removable extra switch, neons and safety shutters.		
25XD	I	Twin Switched Socket Outlet, 250V/10A, double pole and removable extra switch.		

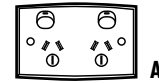

A

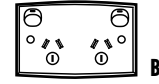

B

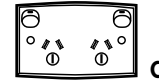

C

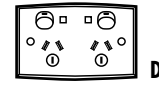

D

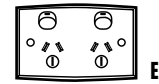

E

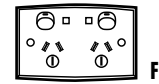

F

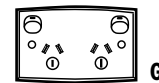

G

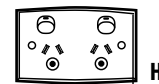

H

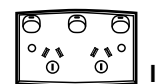

I

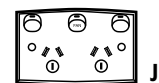

J

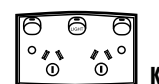

K

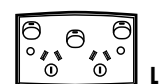

L

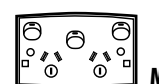

M



25



25N



25D15



25/15N



25X

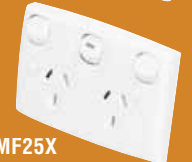

MF25X



ML25X



25XAN

SINGLE & TWIN SWITCHED SOCKET OUTLETS - VERTICALLY MOUNTED

STANDARD SIZE SINGLE SWITCHED SOCKET OUTLETS - VERTICALLY MOUNTED

Cat. No.	Length	Width	Depth	Mounting Centres
All products	115mm	73mm	14mm	84mm apart
15V	A	Single Switched Socket Outlet, 250V/10A.		
15VS	A	Single Switched Socket Outlet, 250V/10A with safety shutters.		
15VN	B	Single Switched Socket Outlet, 250V/10A with safety shutters and neon.		
15V15	C	Single Switched Socket Outlet, 250V/15A.		
15V15N	D	Single Switched Socket Outlet, 250V/15A with safety shutters and neon.		
15VX	E	Single Switched Socket Outlet, 250V/10A with removable extra switch.		
15VXS	E	Single Switched Socket Outlet, 250V/10A with safety shutters and removable extra switch.		
15VXN	F	Single Switched Socket Outlet, 250V/10A with safety shutters, neon and removable extra switch.		
15VXX	G	Single Switched Socket Outlet, 250V/10A with two removable extra switches.		

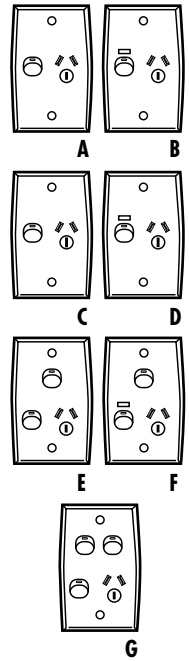

15V



15V15N



15VXX

STANDARD SIZE TWIN SWITCHED SOCKET OUTLETS - VERTICALLY MOUNTED

Cat. No.	Length	Width	Depth	Mounting Centres
15/2V, 15/2VS, 15/2VN, 15D2V,	115mm	73mm	14mm	84mm apart
15DD2V	133mm	83mm	37mm	97mm
25V, 25VXA	115mm	73mm	16mm	84mm apart
15/2V	A	Twin Switched Socket Outlet, 250V/10A, two piece base.		
15/2VS	A	Twin Switched Socket Outlet, 250V/10A with safety shutters, two piece base.		
15/2VN	B	Twin Switched Socket Outlet, 250V/10A with neons and safety shutters, two piece base.		
15D2V	A	Twin Switched Socket Outlet, 250V/10A, double pole, two piece base.		
15DD2V	C	Twin Switched Socket Outlet, 250V/10A, double pole with deep plate, two piece base.		
25V	D	Twin Switched Socket Outlet, 250V/10A.		
25VXA	E	Twin Switched Socket Outlet, 250V/10A with removable extra switch.		

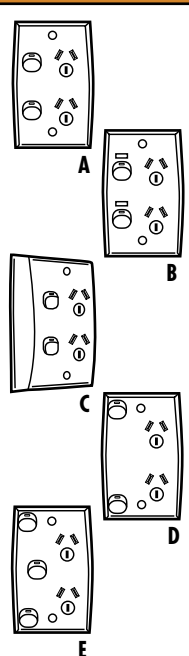

15/2V













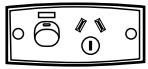

15DD2V







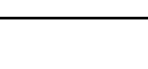



25V

SKIRTING MOUNTED & INTERMEDIATE SWITCHED SOCKET OUTLETS

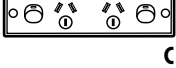

SKIRTING MOUNTED SINGLE SWITCHED SOCKET OUTLETS

Cat. No.	Length	Width	Depth	Mounting Centres		
All products	98mm	45mm	14mm	78mm apart		
16	A	Single Switched Socket Outlet, skirting mounted, 250V/10A with safety shutter (98 x 45mm at centre).				
16N	B	Single Switched Socket Outlet, skirting mounted, 250V/10A with safety shutter and neon (98 x 45mm at centre).				
16F	C	Single Switched Socket Outlet, skirting mounted, 250V/10A, in line terminals (98 x 45mm at centre).				
16/15	D	Single Switched Socket Outlet, skirting mounted, 250V/15A (98 x 45mm at centre).				
16X	E	Single Switched Socket Outlet, skirting mounted, 250V/10A with removable extra switch (125 x 45mm at centre).				
16D	A	Single Switched Socket Outlet, skirting mounted, 250V/10A, double pole (98 x 45mm at centre).				

SKIRTING MOUNTED TWIN SWITCHED SOCKET OUTLETS





Cat. No.	Length	Width	Depth	Mounting Centres		
16/2 Series	168mm	45mm	18mm	145mm apart		
16/2M Series	156mm	44mm	18mm	136mm apart		
16/2	A	Twin Switched Socket Outlet, skirting mounted, 250V/10A (168 x 45mm).				
16/2S	A	Twin Switched Socket Outlet, skirting mounted, 250V/10A, with safety shutters (168 x 45mm).				
16/2N	B	Twin Switched Socket Outlet, skirting mounted, 250V/10A, with neons and safety shutters (168 x 45mm).				
16/2F	C	Twin Switched Socket Outlet, skirting mounted, 250V/10A, with straight sides.				
16/2MF	D	Twin Switched Socket Outlet, skirting mounted, 250V/10A, suits ducting (156 x 44mm).				
16/2MF1510	E	Twin Switched Socket Outlet, skirting mounted, 250V/15A & 10A, suits ducting (156 x 44mm).				
16/2MFD	D	Twin Switched Socket Outlet, skirting mounted, 250V/10A, double pole.				

INTERMEDIATE SINGLE SWITCHED SOCKET OUTLETS - HORIZONTALLY MOUNTED



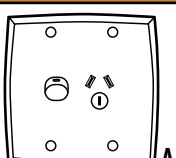

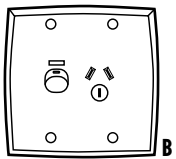
Cat. No.	Length	Width	Depth	Mounting Centres		
14	115mm	61mm	13mm	84mm apart		
14	A	Single Switched Socket Outlet, intermediate size, 250V/10A, horizontal.				

LARGE FORMAT & PROTECTED SWITCHED SOCKET OUTLETS

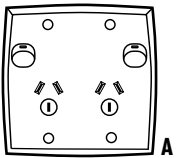

LARGE FORMAT SIZE SINGLE SWITCHED SOCKET OUTLETS - HORIZONTALLY MOUNTED

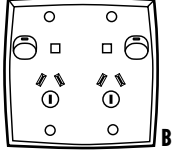
Cat. No.	Length	Width	Depth	Mounting Centres		
All products	115mm	115mm	14mm	84 x 46mm		
15/2	A	Single Switched Socket Outlet, large format, 250V/10A, single pole.				
15/2S	A	Single Switched Socket Outlet, large format, 250V/10A, single pole with safety shutter.				
15/2N	B	Single Switched Socket Outlet, large format, 250V/10A, single pole with safety shutter and neon.				

LARGE FORMAT SIZE TWIN SWITCHED SOCKET OUTLETS - VERTICALLY MOUNTED

Cat. No.	Length	Width	Depth	Mounting Centres		
All products	115mm	115mm	11mm	84 x 46mm		
25/2V	A	Twin Switched Socket Outlet, 250V/10A (115 x 115mm).				
25/2VS	A	Twin Switched Socket Outlet, 250V/10A with safety shutters (115 x 115mm).				
25/2VN	B	Twin Switched Socket Outlet, 250V/10A with neons and safety shutters (115 x 115mm).				

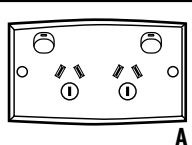
LARGE FORMAT SIZE TWIN SWITCHED SOCKET OUTLETS - HORIZONTALLY MOUNTED

Cat. No.	Length	Width	Depth	Mounting Centres		
23	145mm	86mm	15mm	120mm apart		
23	A	Twin Switched Socket Outlet, large format, 250V/10A.				

Protected Switched Socket Outlets

Electricity brings with it the life threatening danger of electrocution, and accidents do occur. Clipsal Residual Current Devices are renowned for being at the forefront of RCD technology. The 15/15EL and 25EL Series are RCD protected single and twin socket outlets that provide a simple method of individual circuit protection for your safety.

They simply replace existing socket outlets and work by protecting not only their own outlet(s) but all 'downstream' outlets on the same circuit. If a fault occurs, power will be cut in less than 40 milliseconds. The 10mA versions are most commonly used in hospitals and similar locations, whereas the 30mA versions are used in homes and offices.

Surge protection is ideal for protecting electronic devices (computers, TVs, stereos) from damage against harsh surge and spike voltages that can occur on the mains supply to the premises. They could save you thousands of dollars protecting expensive electronic equipment. Please refer to the top of the next page for technical information and dimensions for this range.

SAFETY, COOKER SOCKET & PLUG AND UNIVERSAL SHAVER OUTLETS

PROTECTED SOCKET OUTLETS

Cat. No.	Length	Width	Depth	Mounting Centres
Earth Leakage Protected Outlets	116mm	74mm	30mm	84mm apart
25SF	115mm	73mm	plate - 17mm wall recess - 23mm	84mm apart
15/15EL10	A	Single Switched Socket Outlet, 250V/15A, with RCD, 10mA.		
15/15EL30	A	Single Switched Socket Outlet, 250V/15A, with RCD, 30mA.		
25EL10	B	Twin Switched Socket Outlet, 250V/10A, with RCD, 10mA.		
25EL30	B	Twin Switched Socket Outlet, 250V/10A, with RCD, 30mA.		
25ELSB	C	Spacer Block, (L122 x W83 x H30mm).		
25SF	D	Twin Switched Socket Outlet, 250V/10A, surge protected, (L115 x W73 x H16mm).		
25SFM	E	Surge Filter Mechanism, 250V/10A		

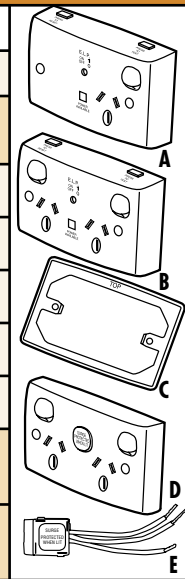

15/15EL10



25ELSB



25SF

Cooker Socket Outlet and Plug

The Cooker Socket Outlet and plug are used so that the stove in a new home can be plugged in by the end user at the last stages of development rather than hard wired by the electrician. This is so that the stove is not a 'sitting duck' in a new home during development for thieves to steal. When maintenance or cleaning is required, it also means that the stove can be unplugged safely.

COOKER SOCKET OUTLET AND PLUG

Cat. No.	Length	Width	Depth	Mounting Centres
31VCS	115mm	73mm	11mm	84mm apart
800CL	A	1.8m, 4mm ² Cord, with 250V/32A 3 pin plug.		
31VCS	B	3 Pin Cooker Socket on Standard Plate, 250V/32A (suits 800CL).		

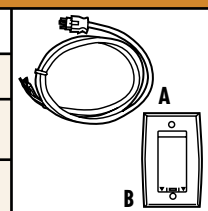

800CL



31VCS

Universal Shaver Outlets

Universal Shaver Outlets are used in hotels where international customers require different voltage outlets and an outlet to plug their shavers into. These are superb products for hotels.

UNIVERSAL SHAVER OUTLET

Cat. No.	Length	Width	Depth	Mounting Centres
727	258mm	73mm	17mm	230 x 40mm
727H	184mm	85mm	18mm	152mm
727V	184mm	85mm	18mm	152mm
727	A	Universal Shaver Outlet, Dual Voltage, 240V - 110V.		
727H	B	Universal Shaver Outlet, Dual Voltage, 240V - 110V (horizontal mount).		
727V	C	Universal Shaver Outlet, Dual Voltage, 240V - 110V (vertical mount).		

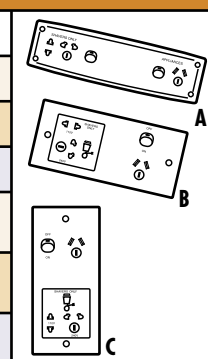

727



727H



727V

TV Antenna Connection Accessories









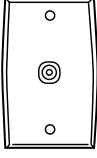

Computers and fax machines are now an everyday part of our lives, not only in the office, but also in our homes. The Standard Range includes TV and communications accessories for every application.

75 Ohm Coaxial Sockets

There are four 75 Ohm coaxial TV sockets available in Standard Range gridplates. Each provides a secure connection to antenna cables to ensure optimum reception.

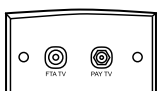
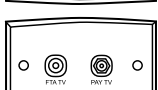
Included in the range is a two gang plate with a TV/FM splitter between TV and radio or other signals to be divided amongst different receivers.

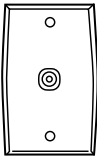
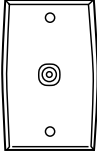
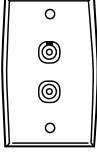
Also included in the Standard Range of telecommunications' accessories is a gridplate that enables easy installation of printed circuit boards.

TV ANTENNA CONNECTION ACCESSORIES						
Cat. No.	Length	Width	Depth	Mounting Centres		
All products	115mm	73mm	11mm	84mm apart		
31VTVA	A	1 Gang Standard Pattern Television Assembly.				
31VTV75	B	TV Antenna Socket in Standard Plate, 75 Ohm.				
31TVF	C	"PAY TV" Antenna Socket, in standard size plate.				
32TVACFF	D	"PAY TV/FTA TV" with a.c. Isolation.				
32TVFF	E	"PAY TV/FTA TV" with F Type Connection.				
32TVSF	F	"PAY TV/FTA TV" Screw Coaxial Connection.				
31VTV75ACF	G	TV Socket with 3kV a.c. Isolation, 75 Ohm in standard size plate.				
31VTV75F	H	TV Socket with F Type Connection, 75 Ohm in standard size plate.				
32VTV75FM	I	TV-FM Splitter, in standard size plate.				

TV CONNECTION SOCKETS, PLUGS & TERMINATORS AND ACCESSORIES

CONNECTION SOCKETS, PLUGS AND TERMINATORS

Cat. No.	Length	Width	Depth	Mounting Centres
30TV75P, 30TV75CS	33mm	11mm	11mm	N/A
30TV75C, 30TV75C1, 30TV75T	18mm	17mm	17mm	N/A
30TV75P	A	Coaxial Cable Plug, 75 Ohm.		
30TV75CS	B	TV Antenna Connection Socket, 75 Ohm.		
30TV75C	C	Coaxial RG59 Cable Connection Plug, 75 Ohm (screw type).		
30TV75C1	D	Coaxial RG9 Cable Connection Plug, 75 Ohm (screw type).		
30TV75T	E	Terminator, suits screw type sockets.		

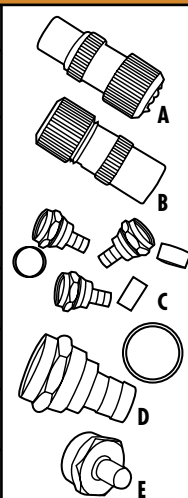





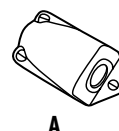

SURFACE MOUNTING CONNECTION ACCESSORY



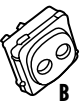

Cat. No.	Length	Width	Depth	Mounting Centres
30TV75S	54mm	29mm	25mm	N/A
30TV75S	A	Coaxial Cable Surface Socket, 75 Ohm.		

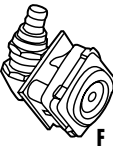

TV ANTENNA MECHANISMS AND FLY LEADS

ANTENNA MECHANISMS				
Cat. No.	Length	Width	Depth	Mounting Centres
30PFM	22mm	22mm	26mm	N/A
30TVM	22mm	22mm	19mm	N/A
30TVFM	21mm	21mm	19mm	N/A
30TV75M	22mm	22mm	38mm	N/A
30TV75MF	22mm	22mm	35mm	N/A
30TV75MACF	22mm	22mm	33mm	N/A
30TV75MS	22mm	22mm	28mm	N/A
30PFM	A	"F" Type Connection, 75 Ohm suits "PAY TV".		
30TVM	B	TV Socket, 300 Ohm type (rear clip).		
30TVFM	C	TV Socket, 300 Ohm type (front clip).		
30TV75M	D	TV Antenna Socket, 75 Ohm, suits 30 series plates.		
30TV75MF	E	TV Antenna Socket, 75 Ohm, with "F" type connection.		
30TV75MACF	F	TV Antenna Socket, 75 Ohm, with 3kV a.c. isolation.		
30TV75MS	G	TV Antenna Socket, 75 Ohm (screw fixing, solderless).		

















Fly Leads

Fly leads are loose, floating cable as opposed to being hard wired, meaning that they are 'free and floating' to allow them to be attached between two points.

FLY LEADS	
Cat. No.	Description
3105FL118MW	A Male to Male Fly Lead, 1.8M.
3105FL118FW	B Male to Female Fly Lead, 1.8M.



CHEMICAL RESISTANT STANDARD INDUSTRIAL RANGE



CHEMICAL RESISTANT STANDARD INDUSTRIAL RANGE

Improved Chemical Resistance

The majority of Clipsal products are manufactured from polycarbonate, which provides excellent performance across a broad spectrum of specific applications. However, the high standards of hygiene required in hospitals and food related industries sometimes involve the use of harsh chemicals which can degrade polycarbonate.

To address these problems, Clipsal have worked closely with their material suppliers to develop an alloy resistant to these chemicals and with only a minimal reduction in impact strength.

The Standard Industrial Range is limited at this time to 16 products and 2 colours. Resistant White (RW)

has been colour matched to standard White Electric. Resistant Soft Grey (RS) has been matched to standard Soft Grey.

Standard Industrial Range products are identifiable by a small symbol on the front of the plate. The 'CR' is for Chemical Resistant and the numeral '1' identifies the material. If other materials come into use at a later time for different applications, different numerals will be used.

To order Standard Industrial Range products use standard product codes and specify Resistant White (RW) or Resistant Soft Grey (RS). All ratings and specifications are the same as the corresponding product in the Standard Range.

CHEMICAL RESISTANT STANDARD INDUSTRIAL RANGE				
Cat. No.	Length	Width	Depth	Mounting Centres
31VA, 32VA, 33VA, 34VA, 35VA, 36VA, 31VX	115mm	73mm	11mm	84mm apart
15, 15X, 15/15, 15V, 25V	115mm	73mm	14mm	84mm apart
25, 25XA	115mm	73mm	16mm	84mm apart
449A	122mm	78mm	32mm	84mm apart
449ASD	116mm	73mm	14mm	84mm apart
31VA	A	Flush Plate, with 1 x 30M mechanism in vertical format.		
32VA	B	Flush Plate, with 2 x 30M mechanism in vertical format.		
33VA	C	Flush Plate, with 3 x 30M mechanism in vertical format.		
34VA	D	Flush Plate, with 4 x 30M mechanism in vertical format.		
35VA	E	Flush Plate, with 5 x 30M mechanism in vertical format.		
36VA	F	Flush Plate, with 6 x 30M mechanism in vertical format.		
31VX	G	Blank Flush Plate.		
15	H	Single Switched Socket Outlet, 250V/10A, horizontal mounting.		
15X	I	Single Switched Socket Outlet, 250V/10A, with extra switch, horizontal mounting.		
15/15	J	Single Switched Socket Outlet, 250V/15A, horizontal mounting.		
15V	K	Single Switched Socket Outlet, 250V/10A, vertical mounting.		
25V	L	Twin Switched Socket Outlet, 250V/10A, single base, vertical mounting.		
25	M	Twin Switched Socket Outlet, 250V/10A, horizontal mounting.		
25XA	N	Twin Switched Socket Outlet, 250V/10A, with extra switch, horizontal mounting.		
449A	O	1 Gang Mounting Block, suits all flush plates with 115 x 73mm and 84mm centres.		
449ASD	P	14mm Spacer, for standard pattern accessories, with 84mm centres, four mounting holes in centre.		

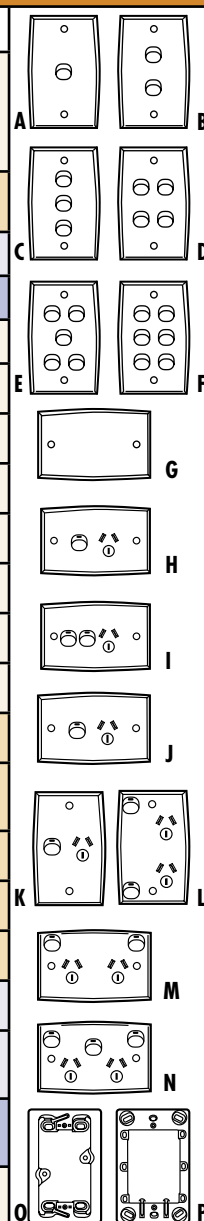

CHEMICAL RESISTANT STANDARD INDUSTRIAL RANGE (Continued)

CHEMICAL COMPARISONS		
Product Type (colour)	Standard Polycarbonate Colours	Resistant White / Resistant Soft Grey
Acids		
Weak Solutions		
Hydrochloric 10%	EXCELLENT	EXCELLENT
Nitric 10%	EXCELLENT	EXCELLENT
Concentrate		
Sulphuric 100%	POOR	POOR
Alkalis		
Weak Solutions		
Sodium Hydroxide 10% (Caustic Soda)	POOR	GOOD
Concentrate		
Potassium Hydroxide 100%	POOR	POOR
Automotive		
Petroleum	POOR	EXCELLENT
Lubricating Oils	POOR	EXCELLENT
Hydraulic Oil	POOR	EXCELLENT
Solvents		
Aliphatic Hydrocarbons (Alkanes)		
Methane	EXCELLENT	EXCELLENT
Propane	EXCELLENT	EXCELLENT
Alcohols		
Ethylene Glycol	EXCELLENT	EXCELLENT
Glycerol (Glycerin)	FAIR	GOOD
Methyl Alcohol (Methanol)	POOR	GOOD
Ethyl Alcohol (Ethanol)	EXCELLENT	EXCELLENT
Amines		
Aniline	POOR	POOR
Aromatic Hydrocarbons		
Methyl Benzene	POOR	GOOD
Xylene	POOR	GOOD
Ethers		
Dimethyl Ethyl	EXCELLENT	EXCELLENT
Ketones		
Acetone	POOR	FAIR
Acetophenone	POOR	FAIR
Ethyl Methyl Ketone	POOR	FAIR

CHEMICAL RESISTANT STANDARD INDUSTRIAL RANGE (Continued)

CHEMICAL COMPARISONS		
Product Type (colour)	Standard Polycarbonate Colours	Resistant White / Resistant Soft Grey
Miscellaneous		
Detergent	EXCELLENT	EXCELLENT
Inorganic Salts		
Magnesium Sulphate	EXCELLENT	EXCELLENT
Oxidising Agents		
Weak Solution		
Sodium Hypochlorite 5%	EXCELLENT	EXCELLENT
Strong Solution		
Hydrogen Peroxide 30%	EXCELLENT	EXCELLENT
Water		
Ambient	EXCELLENT	EXCELLENT
Hot > 60°C	EXCELLENT	GOOD
Steam	POOR	POOR

This table should be used as a guide only. Any end user should test to evaluate the suitability of any chemical, with any plastic.

EXCELLENT	Recommended; no adverse effects after extended exposure.
GOOD	Acceptable; minimal loss of mechanical properties after long periods of exposure.
FAIR	Marginal acceptability; loss of mechanical properties after long periods of exposure.
POOR	Not recommended for use.



PROTECTED SWITCHED SOCKET OUTLETS



Where power is required in Commercial and Industrial applications, the Clipsal Protected Switched Socket range is the perfect product. Built tough to last, and in a number of configurations to suit your needs, this range stands the test of time.

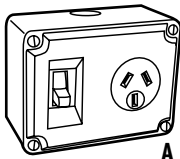

The range is available in zinc die cast and you will find matching switch outlets on page 31.

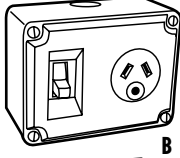

Please see the table below for details on the full range, including dimensional specifications.

PROTECTED SWITCHED SOCKET OUTLETS - 10A				
Cat. No.	Length	Width	Depth	Mounting Centres
PC110, PC110-2FR, PC110-2RF, PC110-N	100mm	79mm	50mm	82mm apart
PC110V-2, PC110V-2-DP,	142mm	102mm	50mm	84 x 82mm apart
PC110	A	Protected Switched Socket Outlet, 250V/10A, zinc die cast, 3 flat sockets.		
PC110-2FR	B	Protected Switched Socket Outlet, 250V/10A, zinc die cast, 2 flat, 1 round socket.		
PC110-2RF		Protected Switched Socket Outlet, 250V/10A, zinc die cast, 2 round, 1 flat socket.		
PC110-N	D	Protected Switched Socket Outlet, 250V/10A, zinc die cast, 3 flat sockets, with neon.		
PC110V-2	E	Protected Switched Socket Outlet, 250V/10A, zinc die cast, 3 flat sockets, vertical mount, 2 gang.		
PC110V-2-DP	E	Protected Switched Socket Outlet, 250V/10A, zinc die cast, 3 flat sockets, vertical mount, 2 gang, double pole.		

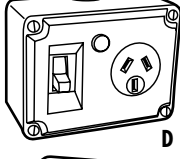



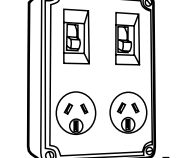





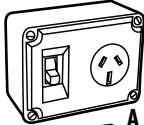

PROTECTED SWITCHED SOCKET OUTLETS - 15A				
Cat. No.	Length	Width	Depth	Mounting Centres
PC115, PC115-N	101mm	79mm	50mm	82mm apart
PC115V-2	141mm	102mm	50mm	84 x 86mm apart
PC115	A	Protected Switched Socket Outlet, 250V/15A, zinc die cast, 3 flat sockets.		
PC115-N	B	Protected Switched Socket Outlet, 250V/15A, zinc die cast, 3 flat sockets, with neons.		
PC115V-2	C	Protected Switched Socket Outlet, 250V/15A, zinc die cast, 3 flat sockets, vertical mount, 2 gang.		

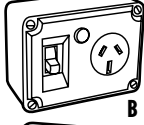

The Clipsal switch shape was always destined for greatness.

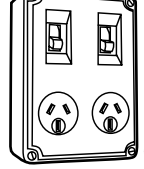
It was first developed in 1963 and proved to be a great leap forward. Unsatisfied with the hard lines of traditional switch rockers at the time, Clipsal engineers fashioned a more stylish alternative. The Standard Range of Switches and Socket Outlets was the first to use the new switch shape.

Over the years the Clipsal switch shape has undergone very subtle changes to adapt to new technologies, plastics and designs. But to the naked eye the original design remains unchanged and is as strong today as it was many years ago. Today, you'll find the Clipsal switch shape in dozens of different switch designs.

The 30 Series can easily be converted from vertical to horizontal mounting by removing the mechanism and turning it through 90°. Most switch bases fit a 22mm diameter hole and have terminal bores of 4.1mm unless specified otherwise.

Switch assemblies are also available with the switch mechanisms further secured by screws located behind the switchplate. These assemblies are designed to prevent the mechanisms being forced out of the switchplate which is important when the switches are used in areas where they may be subjected to vandalism or undue physical abuse.

The gentle curves of the overall shape are equally proportioned to provide uncomplicated symmetry. It is this flexibility and strength in design that has enabled the Clipsal switch shape to adapt to just about every Clipsal switch and socket range that has been designed since the 1960s.

Quality Assurance surrounds everything Clipsal does and production of the Clipsal switch shape is no exception. Clipsal was the first Australian manufacturer of electrical wiring accessories to achieve quality endorsed status and is now recognised by quality status systems around the world.

It is this commitment to quality that has given the Clipsal switch shape its longevity. Its sleek styling was an immediate success.











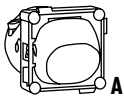

















And through Clipsal's dedication to perfection and continuous improvement it has remained so. Indeed, we like to think it will always be that way.

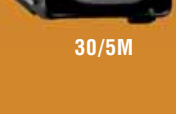

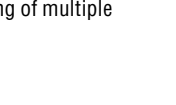
The shape of the switch dolly is a trademark of Clipsal Australia Pty Ltd

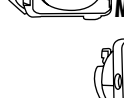
30 SERIES SWITCH MECHANISMS



SWITCH MECHANISMS

Cat. No.	Description		
30M	A 250V/10A, 1 way/2 way - terminal bores of 4.1mm ϕ accommodate 4 x 1.5mm ² or 3 x 2.5mm ² cables. Body fits 22mm ϕ hole. M rating is 100.		
30MRD	B 250V/10A, 1 way/2 way (with red dolly mark) - terminal bores of 4.1mm ϕ accommodate 4 x 1.5mm ² or 3 x 2.5mm ² cables. Body fits 22mm ϕ hole. M rating is 100.		
30FLM	A 250V/10A, 1 way/2 way (suits fluoro loads) - terminal bores of 4.1mm ϕ accommodate 4 x 1.5mm ² or 3 x 2.5mm ² cables. Body fits 22mm ϕ hole. M rating is 120.		
30FLM15	A 250V/15A, 1 way/2 way (suits fluoro loads) - terminal bores of 4.1mm ϕ accommodate 4 x 1.5mm ² or 3 x 2.5mm ² cables. Body fits 22mm ϕ hole. M rating is 90.		
30RSM2	C 250V/15A, Rotary (2 On - 2 Off) - also suitable for 12V d.c. 15A, and audio and control applications. Switch positions indicated in window. M rating is 50.		
30RSM3	C 250V/15A, Rotary (3 On - 1 Off) - also suitable for 12V d.c. 15A, and audio and control applications. Switch positions indicated in window. M rating is 50.		
30MCO	A 250V/10A, Changeover, double throw (selects alternate circuits).		
30MI	D 250V/10A, Intermediate - four terminals of 3.5mm ϕ accommodates 2 x 2.5mm ² cables. Body fits 22mm ϕ hole.		
30MBP	E 440V/15A, Bell press - offers facility for momentary ON or OFF (one Looping terminal).		
30MBPN	F 250V/15A, Illuminated bell press - offers facility for momentary ON or OFF. Neon is connected across terminals 1 & 4. Alternative lamp voltages available.		
30MBPR	G 250V/10A, Bell press rocker - offers facility for momentary ON or OFF. Suitable for extra low voltage applications (one Looping terminal).		
30MD	D 250V/10A, 1 way, double pole, single throw - terminal bores of 4.1mm ϕ accommodate 4 x 1.5mm ² or 3 x 2.5mm ² cables. Body fits 22mm ϕ hole. M rating is 90.		
30HMD	H 250V/10A, double pole, marked "HEAT".		
30MD2	I 250V/10A, 2 Way, double pole, double throw - six terminal bores of 4.1mm ϕ accommodate 4 x 1.5mm ² or 3 x 2.5mm ² cables. M rating is 75.		
30MD15	O 250V/15A, 1 way, double pole, single throw - terminal bores of 4.1mm ϕ accommodate 4 x 1.5mm ² or 3 x 2.5mm ² cables. Body fits 22mm ϕ hole. M rating is 90.		
30MD20	J 250V/20A, 1 way, double pole - 4 terminals of 1.5mm ϕ accommodate 3 x 2.5mm ² cables. Body fits 34mm ϕ hole. M rating is 100.		
30M15	A 250V/15A, 1 way/2 way - terminal bores of 4.1mm ϕ accommodate 4 x 1.5mm ² or 3 x 2.5mm ² cables. Body fits 22mm ϕ hole. M rating is 90.		
30M15RD	B 250V/15A, 1 way/2 way (with red dolly mark) - terminal bores of 4.1mm ϕ accommodate 4 x 1.5mm ² or 3 x 2.5mm ² cables. Body fits 22mm ϕ hole. M rating is 90.		
30M20	A 250V/20A, 1 way/2 way - terminal bores of 4.1mm ϕ accommodate 4 x 1.5mm ² or 3 x 2.5mm ² cables. Body fits 22mm ϕ hole. M rating is 90.		
30M35	N 250V/35A, 1 way/2 way - terminal bore of 3.6mm ϕ & Looping terminal bore of 3.9mm ϕ . M rating is 160. Marked 35A.		
30TKM	K 250V/20A (5A fluorescent load), 1 way/2 way, toggle key actuated - one Looping terminal. M rating is 100.		
30/1/2LM	A 250V/10A, 1 way (two Looping terminals) - terminal bores of 4.1mm ϕ accommodate 4 x 1.5mm ² or 3 x 2.5mm ² cables. Body fits 22mm ϕ hole. M rating is 100.		
30/1ELM	P 250V/10A, 1 way (one Looping & one Earth terminal) - terminal bores of 4.1mm ϕ accommodate 4 x 1.5mm ² or 3 x 2.5mm ² cables. Body fits 22mm ϕ hole. M rating is 100.		
30/1NM	L 250V/10A, 1 way rocker with neon indicator - neon can be wired to indicate ON, OFF or POWER AVAILABLE. Looping/switch terminal bores of 4.1mm ϕ . Body fits 34mm ϕ hole (Note: Neutral required).		
30/2NM	L 250V/10A, 2 way rocker with neon indicator - neon can be wired to indicate ON, OFF or POWER AVAILABLE. Looping/switch terminal bores of 4.1mm ϕ . Body fits 34mm ϕ hole (Note: Neutral not required).		
30/5M	M 250V/10A, 1 way/2 way (with 5 terminals - one Looping and one Earth terminal). Terminal bore of Common, Looping and Earth of 5.3mm ϕ accommodates 4 x 2.5mm ² cables. Terminal bore of '1' and '2' of 4.1mm ϕ accommodates 4 x 1.5mm ² or 3 x 2.5mm ² cables. Body fits 26mm ϕ hole. M rating is 40.		

Note: 30M Series products have fluorescent capacity of **approximately 5A**. 30MD and 30MI are not recommended for switching of multiple fluorescent fittings.

30 SERIES SWITCH MECHANISMS (Continued)

NEON INDICATOR MECHANISMS











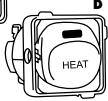

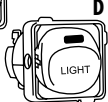



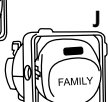

Cat. No.	Description		
30N-RED	A 250V - neon indicator (RED)		
30N-COLOUR	A 250V - neon indicator (OTHER COLOURS)		

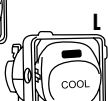
Colours available are Blue, Green, Amber and Transparent. Other voltages are also available, including 6, 12, 24, 32, 48, 110 and 440. Suitable for DC loads. To order, add voltage to Cat. No. (for example, 30N12). Neons draw 250-275mW at 240V. Note: Inductive loads occasionally cause neons to glow in OFF position. To prevent this, place a 47kΩ, 0.5W 240V resistor across the terminals. Neutral and Active can be connected to either terminal.

Labelled Switch Mechanisms

Clipsal offers a broad range of labelled switch mechanisms for easy identification when several switches are installed on the same switchplate or when there is any chance of confusion over the load controlled.

10A MECHANISMS - WITH MESSAGES

Cat. No.	Description		
30FM	A 250V/10A, 2 way (marked "FAN") - terminal bores of 4.1mm Ø accommodate 4 x 1.5mm ² or 3 x 2.5mm ² cables. Body fits 22mm Ø hole. M rating is 100.	              	
30HM	B 250V/10A, 2 way (marked "HEAT") - terminal bores of 4.1mm Ø accommodate 4 x 1.5mm ² or 3 x 2.5mm ² cables. Body fits 22mm Ø hole. M rating is 100.		
30EM	C 250V/10A, 2 way (marked "EXHAUST") - terminal bores of 4.1mm Ø accommodate 4 x 1.5mm ² or 3 x 2.5mm ² cables. Body fits 22mm Ø hole. M rating is 100.		
30LM	D 250V/10A, 2 way (marked "LIGHT") - terminal bores of 4.1mm Ø accommodate 4 x 1.5mm ² or 3 x 2.5mm ² cables. Body fits 22mm Ø hole. M rating is 100.		
30MAM	E 250V/10A, 2 way (marked "MANUAL-AUTO") - terminal bores of 4.1mm Ø accommodate 4 x 1.5mm ² or 3 x 2.5mm ² cables. Body fits 22mm Ø hole. M rating is 100.		
30PM	F 250V/10A, 2 way (marked "DISPOSAL") - terminal bores of 4.1mm Ø accommodate 4 x 1.5mm ² or 3 x 2.5mm ² cables. Body fits 22mm Ø hole. M rating is 100.		
30XM	G 250V/10A, 2 way (marked "WASTE") - terminal bores of 4.1mm Ø accommodate 4 x 1.5mm ² or 3 x 2.5mm ² cables. Body fits 22mm Ø hole. M rating is 100.		
30YM	H 250V/10A, 2 way (marked "WASH") - terminal bores of 4.1mm Ø accommodate 4 x 1.5mm ² or 3 x 2.5mm ² cables. Body fits 22mm Ø hole. M rating is 100.		
30DNM	I 250V/10A, 2 way (marked "DAY/NIGHT") - terminal bores of 4.1mm Ø accommodate 4 x 1.5mm ² or 3 x 2.5mm ² cables. Body fits 22mm Ø hole. M rating is 100.		
30FAM	J 250V/10A, 2 way (marked "FAMILY") - terminal bores of 4.1mm Ø accommodate 4 x 1.5mm ² or 3 x 2.5mm ² cables. Body fits 22mm Ø hole. M rating is 100.		
30TM	K 250V/10A, 2 way (marked "T.V.") - terminal bores of 4.1mm Ø accommodate 4 x 1.5mm ² or 3 x 2.5mm ² cables. Body fits 22mm Ø hole. M rating is 100.		
30COM	L 250V/10A, 2 way (marked "COOL") - terminal bores of 4.1mm Ø accommodate 4 x 1.5mm ² or 3 x 2.5mm ² cables. Body fits 22mm Ø hole. M rating is 100.		
30AUM	M 250V/10A, 2 way (marked "AUTO") - terminal bores of 4.1mm Ø accommodate 4 x 1.5mm ² or 3 x 2.5mm ² cables. Body fits 22mm Ø hole. M rating is 100.		
30ACM	N 250V/10A, 2 way (marked "AIR CON") - terminal bores of 4.1mm Ø accommodate 4 x 1.5mm ² or 3 x 2.5mm ² cables. Body fits 22mm Ø hole. M rating is 100.		
30STM	O 250V/10A, 2 way (marked "STUDY") - terminal bores of 4.1mm Ø accommodate 4 x 1.5mm ² or 3 x 2.5mm ² cables. Body fits 22mm Ø hole. M rating is 100.		

30 SERIES SWITCH MECHANISMS (Continued)

10A MECHANISMS - WITH MESSAGES (CONTINUED)

Cat. No.	Description		
30PUM	P 250V/10A, 2 way (marked "PUMP") - terminal bores of 4.1mm ϕ accommodate 4 x 1.5mm ² or 3 x 2.5mm ² cables. Body fits 22mm ϕ hole. M rating is 100.		
30BM	Q 250V/10A, 2 way (marked "BATH") - terminal bores of 4.1mm ϕ accommodate 4 x 1.5mm ² or 3 x 2.5mm ² cables. Body fits 22mm ϕ hole. M rating is 100.		
30KM	R 250V/10A, 2 way (marked "KITCHEN") - terminal bores of 4.1mm ϕ accommodate 4 x 1.5mm ² or 3 x 2.5mm ² cables. Body fits 22mm ϕ hole. M rating is 100.		
30RUM	S 250V/10A, 2 way (marked "RUMPUS") - terminal bores of 4.1mm ϕ accommodate 4 x 1.5mm ² or 3 x 2.5mm ² cables. Body fits 22mm ϕ hole. M rating is 100.		
30LOM	T 250V/10A, 2 way (marked "LOUNGE") - terminal bores of 4.1mm ϕ accommodate 4 x 1.5mm ² or 3 x 2.5mm ² cables. Body fits 22mm ϕ hole. M rating is 100.		
30DM	U 250V/10A, 2 way (marked "DINE") - terminal bores of 4.1mm ϕ accommodate 4 x 1.5mm ² or 3 x 2.5mm ² cables. Body fits 22mm ϕ hole. M rating is 100.		
30FNM	V 250V/10A, 2 way (marked "OFF/ON") - terminal bores of 4.1mm ϕ accommodate 4 x 1.5mm ² or 3 x 2.5mm ² cables. Body fits 22mm ϕ hole. M rating is 100.		
30AM	W 250V/10A, 2 way (marked "ALARM") - terminal bores of 4.1mm ϕ accommodate 4 x 1.5mm ² or 3 x 2.5mm ² cables. Body fits 22mm ϕ hole. M rating is 100.		
30BDM	X 250V/10A, 2 way (marked "BED") - terminal bores of 4.1mm ϕ accommodate 4 x 1.5mm ² or 3 x 2.5mm ² cables. Body fits 22mm ϕ hole. M rating is 100.		
30BD1M	Y 250V/10A, 2 way (marked "BED1") - terminal bores of 4.1mm ϕ accommodate 4 x 1.5mm ² or 3 x 2.5mm ² cables. Body fits 22mm ϕ hole. M rating is 100.		
30BD2M	Z 250V/10A, 2 way (marked "BED2") - terminal bores of 4.1mm ϕ accommodate 4 x 1.5mm ² or 3 x 2.5mm ² cables. Body fits 22mm ϕ hole. M rating is 100.		
30BD3M	1 250V/10A, 2 way (marked "BED3") - terminal bores of 4.1mm ϕ accommodate 4 x 1.5mm ² or 3 x 2.5mm ² cables. Body fits 22mm ϕ hole. M rating is 100.		
30BD4M	2 250V/10A, 2 way (marked "BED4") - terminal bores of 4.1mm ϕ accommodate 4 x 1.5mm ² or 3 x 2.5mm ² cables. Body fits 22mm ϕ hole. M rating is 100.		
30HLM	3 250V/10A, 2 way (marked "HI/LOW") - terminal bores of 4.1mm ϕ accommodate 4 x 1.5mm ² or 3 x 2.5mm ² cables. Body fits 22mm ϕ hole. M rating is 100.		
30MSEN	4 250V/10A, 2 way (marked "SENSOR") - terminal bores of 4.1mm ϕ accommodate 4 x 1.5mm ² or 3 x 2.5mm ² cables. Body fits 22mm ϕ hole. M rating is 100.		
30MOS	5 250V/10A, 2 way (marked "OUTSIDE") - terminal bores of 4.1mm ϕ accommodate 4 x 1.5mm ² or 3 x 2.5mm ² cables. Body fits 22mm ϕ hole. M rating is 100.		
30MFR	6 250V/10A, 2 way (marked "FORWARD/REVERSE") - terminal bores of 4.1mm ϕ accommodate 4 x 1.5mm ² or 3 x 2.5mm ² cables. Body fits 22mm ϕ hole. M rating is 100.		
30MFD	7 250V/10A, 2 way (marked "FRIDGE") - terminal bores of 4.1mm ϕ accommodate 4 x 1.5mm ² or 3 x 2.5mm ² cables. Body fits 22mm ϕ hole. M rating is 100.		
30MMW	8 250V/10A, 2 way (marked "MICROWAVE") - terminal bores of 4.1mm ϕ accommodate 4 x 1.5mm ² or 3 x 2.5mm ² cables. Body fits 22mm ϕ hole. M rating is 100.		
30MZ1	9 250V/10A, 2 way (marked "ZONE1") - terminal bores of 4.1mm ϕ accommodate 4 x 1.5mm ² or 3 x 2.5mm ² cables. Body fits 22mm ϕ hole. M rating is 100.		

30 SERIES SWITCH MECHANISMS (Continued)

10A MECHANISMS - WITH MESSAGES (CONTINUED)

Cat. No.	Description		
30MZ2	10 250V/10A, 2 way (marked "ZONE2") - terminal bores of 4.1mm \varnothing accommodate 4 x 1.5mm ² or 3 x 2.5mm ² cables. Body fits 22mm \varnothing hole. M rating is 100.		
30MZ3	11 250V/10A, 2 way (marked "ZONE3") - terminal bores of 4.1mm \varnothing accommodate 4 x 1.5mm ² or 3 x 2.5mm ² cables. Body fits 22mm \varnothing hole. M rating is 100.		
30MZ4	12 250V/10A, 2 way (marked "ZONE4") - terminal bores of 4.1mm \varnothing accommodate 4 x 1.5mm ² or 3 x 2.5mm ² cables. Body fits 22mm \varnothing hole. M rating is 100.		
39M	13 250V/10A, 3 Position - marked "HI-OFF-LO" . Three terminals, 3.5mm \varnothing accommodate 2 x 2.5mm ² cables.		
39MAOM	14 250V/10A, 3 Position - marked "MAN-OFF-AUTO" . Three terminals, 3.5mm \varnothing accommodate 2 x 2.5mm ² cables.		
39MSON	15 250V/10A, 3 Position - marked "SENSOR-OFF-ON" . Three terminals, 3.5mm \varnothing accommodate 2 x 2.5mm ² cables.		

16A MECHANISMS - WITH MESSAGES

Cat. No.	Description		
30M16SEN	A 250V/16A, 2 way (marked "SENSOR") - terminal bores of 4.1mm \varnothing accommodate 4 x 1.5mm ² or 3 x 2.5mm ² cables. Body fits 22mm \varnothing hole. M rating is 100.		
30M16OS	B 250V/16A, 2 way (marked "OUTSIDE") - terminal bores of 4.1mm \varnothing accommodate 4 x 1.5mm ² or 3 x 2.5mm ² cables. Body fits 22mm \varnothing hole. M rating is 100.		
30M16FR	C 250V/16A, 2 way (marked "FORWARD/REVERSE") - terminal bores of 4.1mm \varnothing accommodate 4 x 1.5mm ² or 3 x 2.5mm ² cables. Body fits 22mm \varnothing hole. M rating is 100.		
30M16FD	D 250V/16A, 2 way (marked "FRIDGE") - terminal bores of 4.1mm \varnothing accommodate 4 x 1.5mm ² or 3 x 2.5mm ² cables. Body fits 22mm \varnothing hole. M rating is 100.		
30M16MW	E 250V/16A, 2 way (marked "MICROWAVE") - terminal bores of 4.1mm \varnothing accommodate 4 x 1.5mm ² or 3 x 2.5mm ² cables. Body fits 22mm \varnothing hole. M rating is 100.		

20A MECHANISMS - WITH MESSAGES

Cat. No.	Description		
30M20HW	A 250V/20A, 2 way (marked "HOT WATER SERVICE") - terminal bores of 4.1mm \varnothing accommodate 4 x 1.5mm ² or 3 x 2.5mm ² cables. Body fits 22mm \varnothing hole. M rating is 100.		

35A MECHANISMS - WITH MESSAGES

Cat. No.	Description		
30M35HOB	A 250V/35A, 2 way (marked "HOB") - terminal bores of 4.1mm \varnothing accommodate 4 x 1.5mm ² or 3 x 2.5mm ² cables. Body fits 22mm \varnothing hole. M rating is 100.		
30M35OV	B 250V/35A, 2 way (marked "OVEN") - terminal bores of 4.1mm \varnothing accommodate 4 x 1.5mm ² or 3 x 2.5mm ² cables. Body fits 22mm \varnothing hole. M rating is 100.		
30M35R	C 250V/35A, 2 way (marked "RANGE") - terminal bores of 4.1mm \varnothing accommodate 4 x 1.5mm ² or 3 x 2.5mm ² cables. Body fits 22mm \varnothing hole. M rating is 100.		

30 SERIES SWITCH MECHANISMS (Continued)

10A ILLUMINATED ROCKER SWITCH MECHANISMS - WITH MESSAGES

Cat. No.	Description		
30/2NMSEN	A 250V/10A - 2 way inbuilt neon (marked "SENSOR"). Neon can be wired to indicate ON, OFF or POWER AVAILABLE. Looping/switch terminals of bore 3.9mm ø. Body fits 34mm ø hole.		 30/2NMSEN
30/2NMOS	B 250V/10A - 2 way inbuilt neon (marked "OUTSIDE"). Neon can be wired to indicate ON, OFF or POWER AVAILABLE. Looping/switch terminals of bore 3.9mm ø. Body fits 34mm ø hole.		

Note: Neutral is not required.

Additional messages available. Contact your CLIPSAL office for details.

Typical messages:- RANGE - HEAT/COOL - RESET - LIVING - HI/LO - SPA - DAY NIGHT - HWS - LO - OFF - ON.

DIMMER, FAN CONTROL AND SURGE FILTER MECHANISMS

Cat. No.	Description		
32E450LM	A C-Thru® Dimmer Mechanism, Leading Edge (suits incandescent lighting and low voltage lighting using iron core transformers), 220 - 240V/450W.		
32E450TM	A C-Thru® Dimmer Mechanism, Trailing Edge (suits incandescent lighting and low voltage lighting using electronic transformers), 220 - 240V/450W.		
32E500FM	A C-Thru® Fan Speed Controller Mechanism, 220-240V/500W.		
30POTDM	B Dimmer Potentiometer (suits products such as 32 Series High Powered Dimmers, 780 Series and the 761 Series).		
30POTFM	C Fan Controller Potentiometer (suits products such as 32 Series High Powered Dimmers & 761 Series).		
30SFM	D Surge Filter Mechanism - 250V 10A		

CIRCUIT IDENTIFICATION AND BLANKING PRODUCTS

Cat. No.	Description		
30P	A Removable Blank Plug, to suit or blank out 30 Series aperture.		 30P 30PID
30PID	B Removable Plug, with identification facility, supplied with tamper proof transparent cover.		
30PFO	C Plug, marked "FRIDGE - FREEZER ONLY".		
30PIDA4L	D Label Sheets, 10 x A4 packet, red and white available (non-adhesive).		

SCHEMATIC WIRING DIAGRAMS

One-Way Mechanism with Neon Indicator



30/1NM

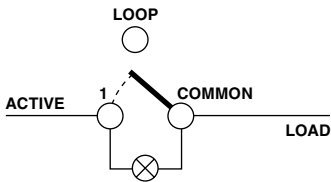
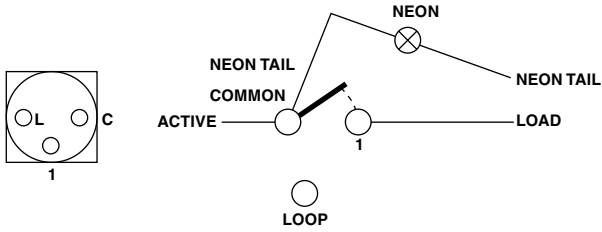

To wire neon "ON" when switch "OFF"

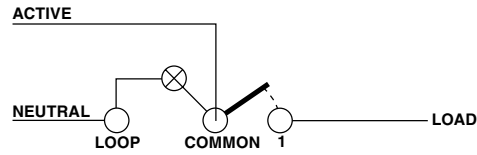

To wire neon permanently "ON"

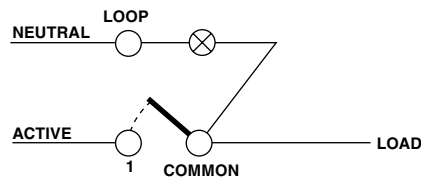

To wire neon "ON" when switch "ON"

One-Way/Two-Way Mechanism with Neon Indicator



30/2NM

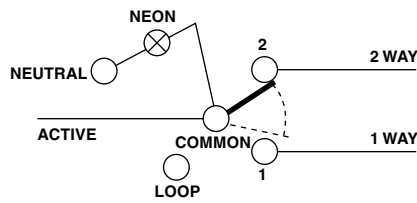
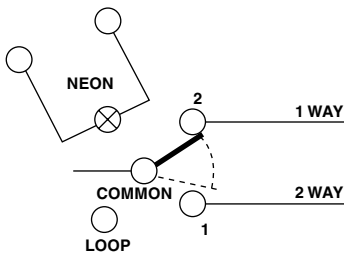

To wire neon permanently "ON"

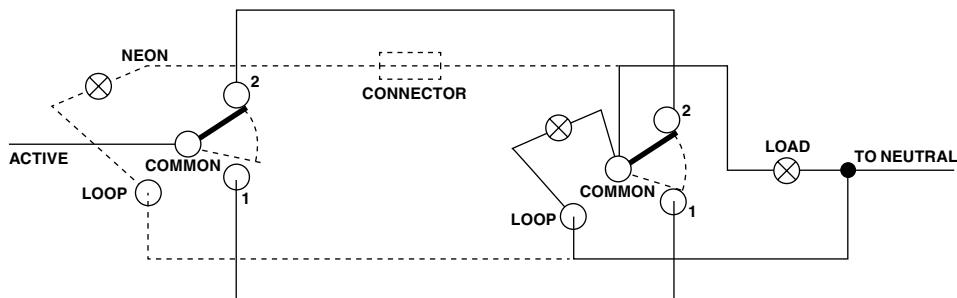

To wire neon "ON" when LOAD "ON"

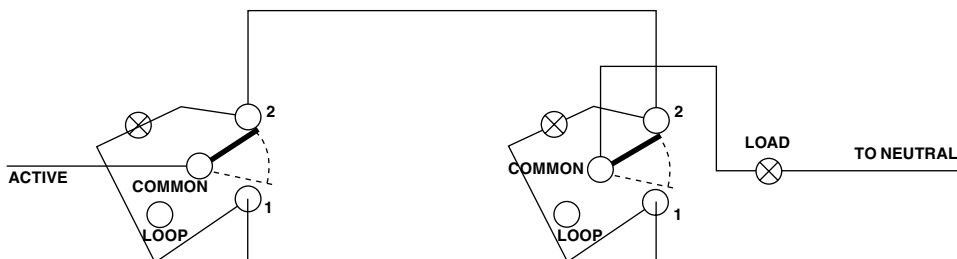

To wire neon "ON" when LOAD "OFF"

SCHEMATIC WIRING DIAGRAMS (Continued)

One-Way/Two-Way Mechanisms

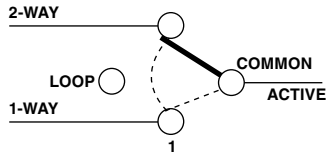
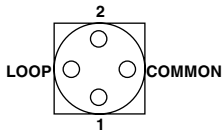

30M
30M15
30M20
30M35

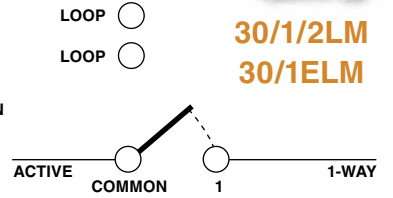
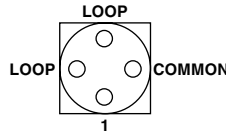

30/1/2LM
30/1ELM

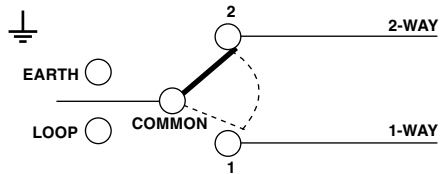
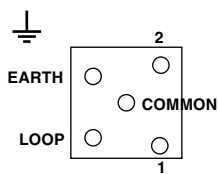

30/5M
30/5M15



Double Pole Mechanisms

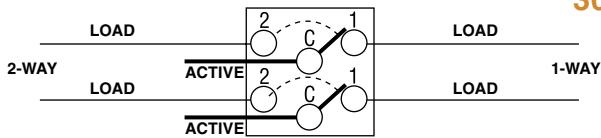

30MD2

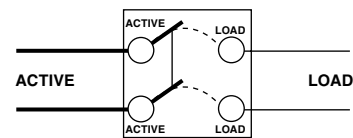

30MD20

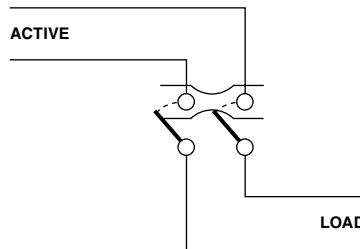
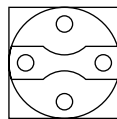

30MD
30MD15



Rotary Switch Mechanisms



30RSM2

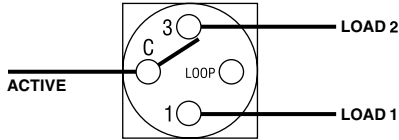

30RSM3

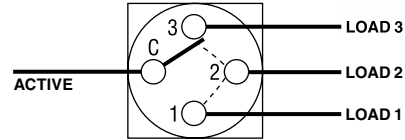

Intermediate Mechanism



30MI

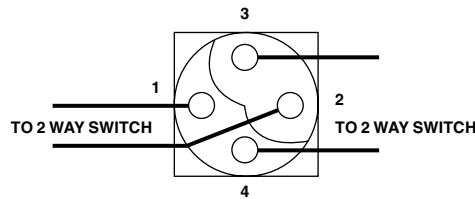

Position 1 (Up)

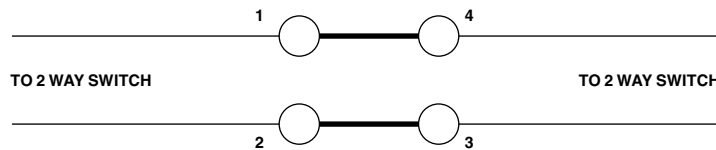

Position 2 (Down)

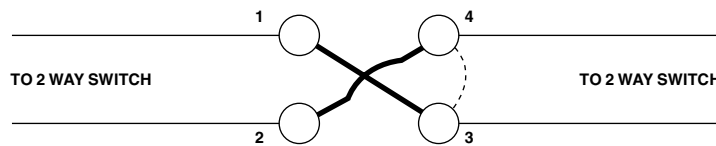

Changeover Mechanism



30MCO

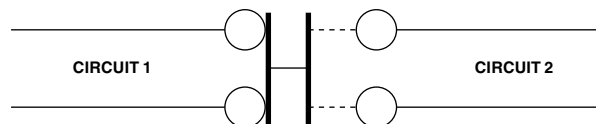
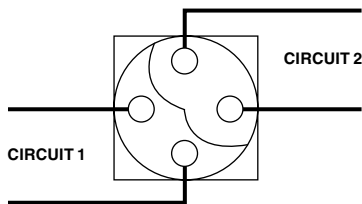

SCHEMATIC WIRING DIAGRAMS (Continued)

Three Position Switch Mechanisms

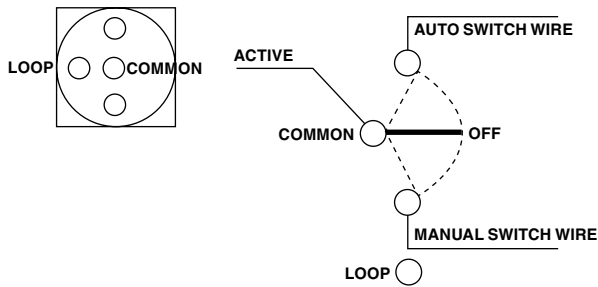

39M

C-Thru® Light Dimmer/Fan Controller



32E450L Series
32E450T Series



32E500F Series

One Way Switching

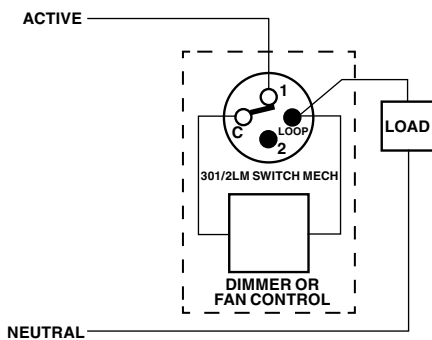

Two Way Switching

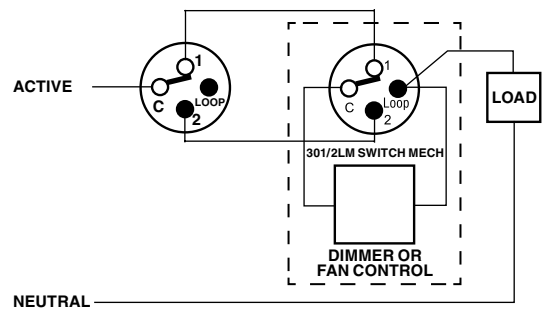

Note: All C-Thru® dimmer plate variants are supplied with a 301/2LM switch mechanism. This mech is designed to be reconfigurable:

DEFAULT STATE: 1-WAY WITH TWO LOOPING TERMINALS (marked "LOOP" and "2" above).

ALTERNATE STATE: 2-WAY WITH ONE LOOPING TERMINAL (which is marked "LOOP" above).

To change over, remove terminal screws and interchange "2" and "LOOP" terminal poles/contacts. Reinsert screws and terminate wiring as usual.

High Power Dimmers



31E1000L
31E800T

One Way Switching

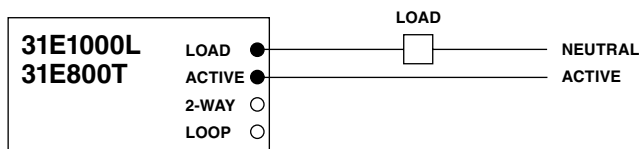

Two Way Switching

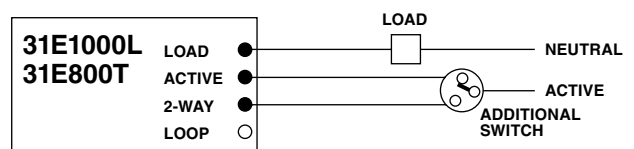

3-Speed Capacitive Fan Controller

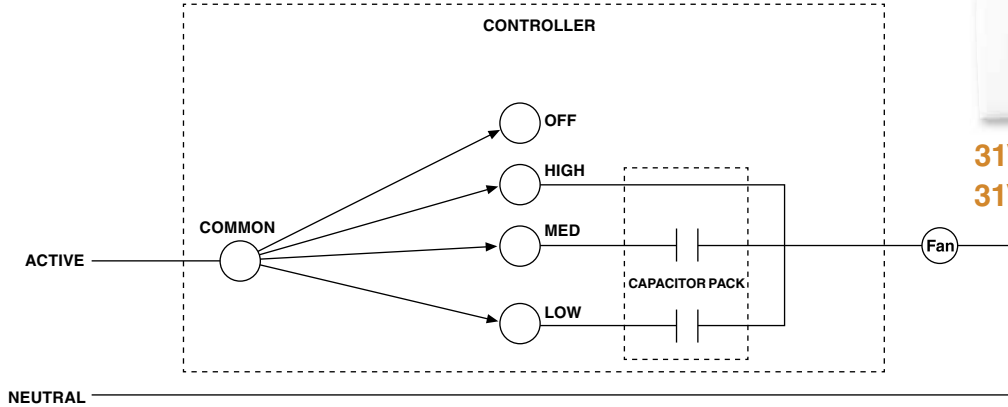

**31VF3CA
31VF3CB**

Combined Light Switch and Time Delay for Fans

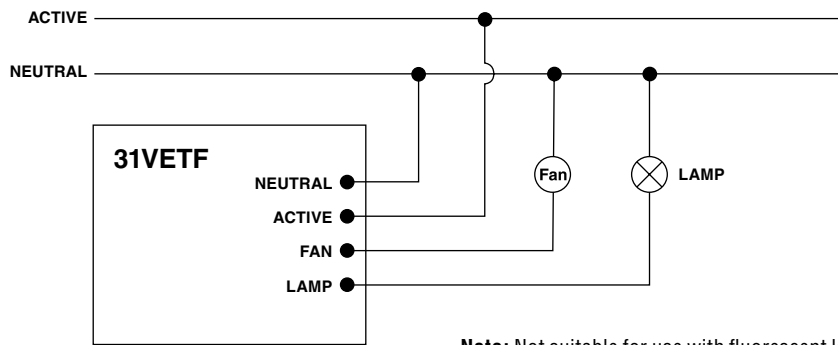

31VETF

Note: Not suitable for use with fluorescent loads.

Push-Button Electronic Time Delay Switch

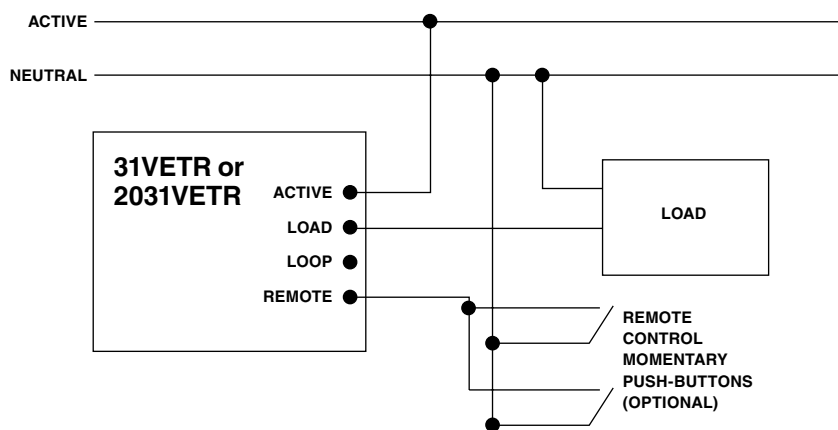

31VETR

No Voltage Relay Switched Sockets

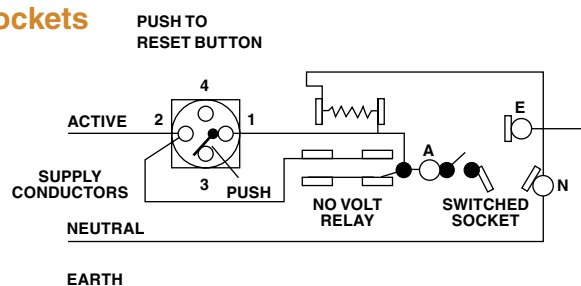
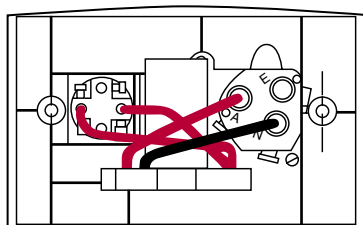

15X15RZ

SCHEMATIC WIRING DIAGRAMS (Continued)

SCHEMATIC WIRING DIAGRAMS (Continued)

Automatic Socket

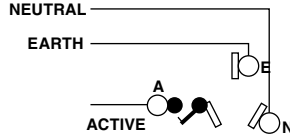
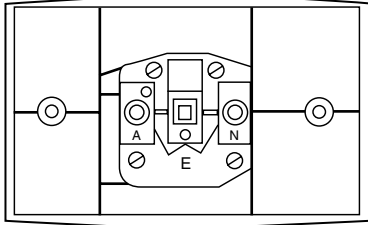

10

Standard Pattern Mounting, Single Gang

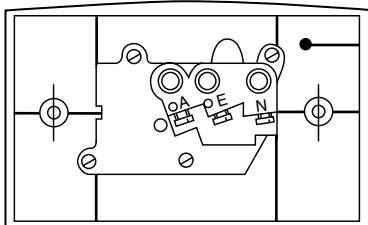

Inline Base

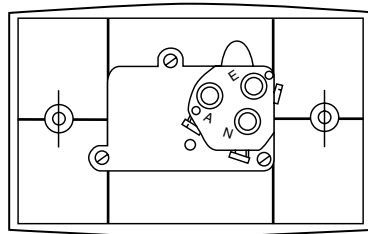

Round Base

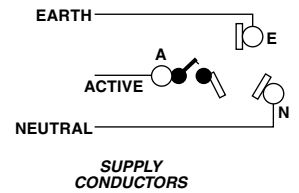
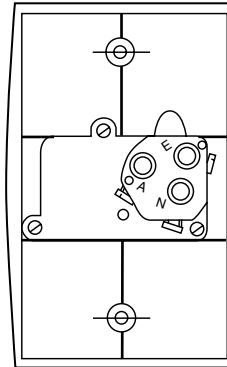

15
15/2



15V

Switched Socket with One Extra Switch

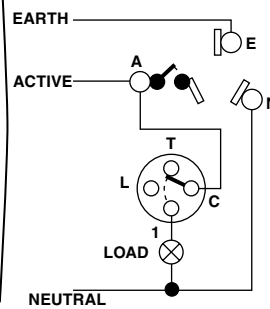
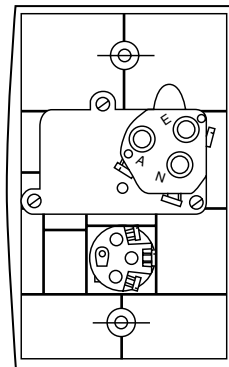
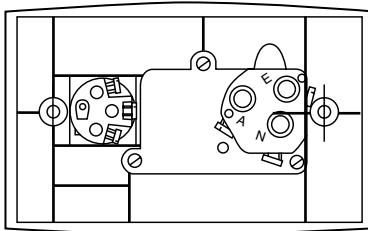

15X



15VX

Switched Socket with Two Extra Switches

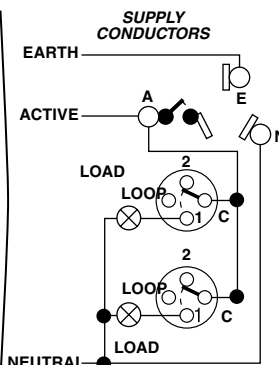
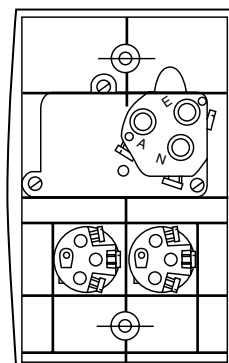
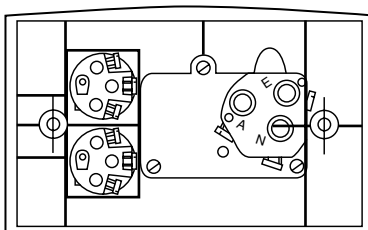

15XX



15VXX

SCHEMATIC WIRING DIAGRAMS (Continued)

Standard Pattern Mounting Twin Combination

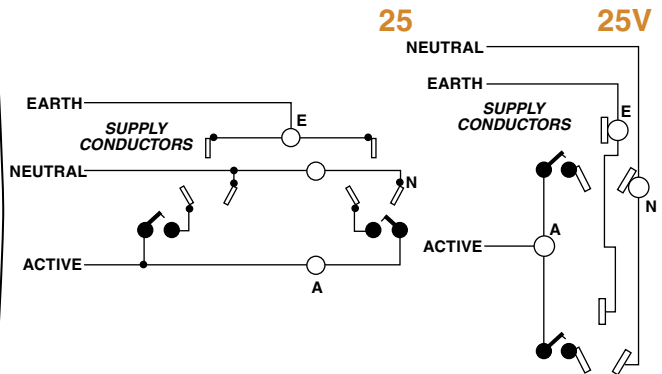
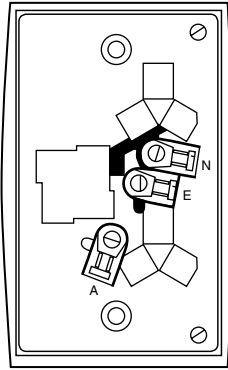
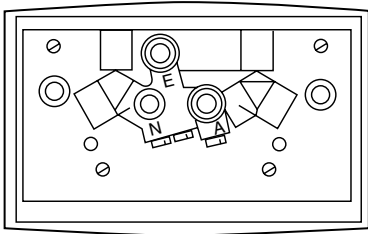

Twin Switched Sockets with Extra Switch

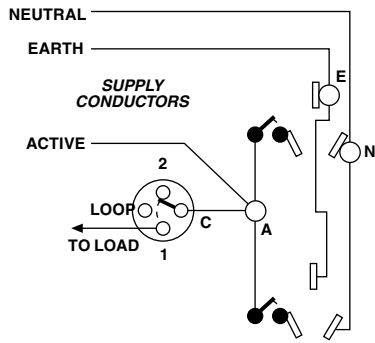
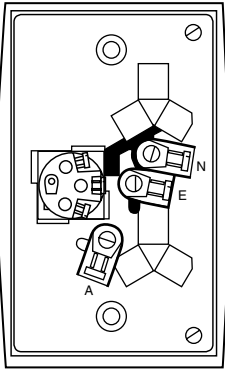

25XA

25VXA

Double Pole Twin Switched Sockets

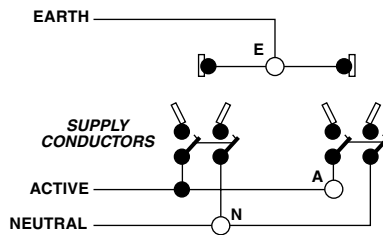
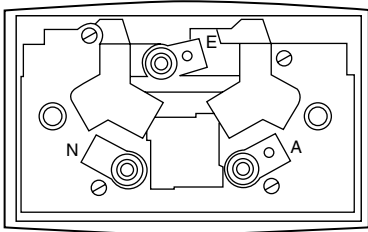

25D

Earth Leakage Protected Twin Switched Sockets

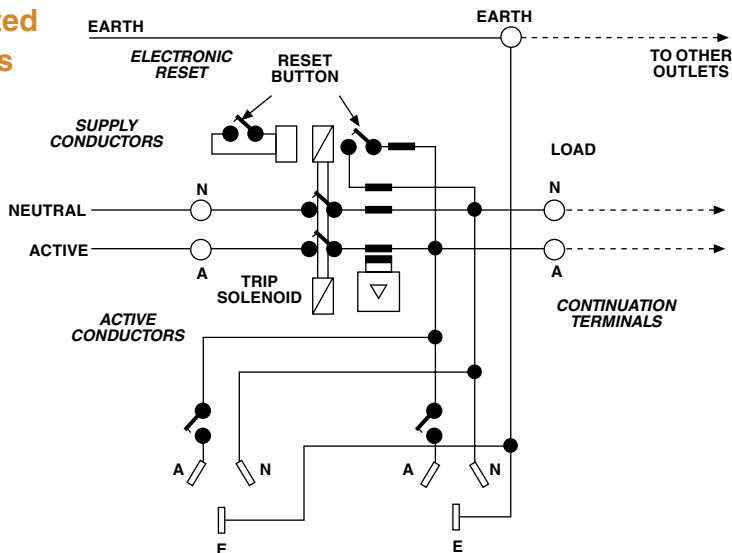

25EL Series

**ARCHITRAVE AND STANDARD SIZE SWITCHPLATES
- MOUNTING TEMPLATES**

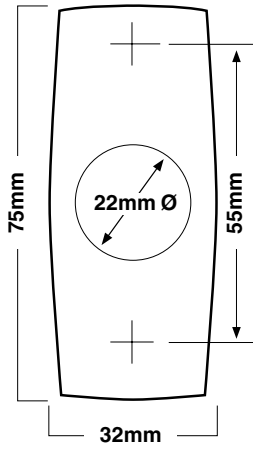

**30
31**

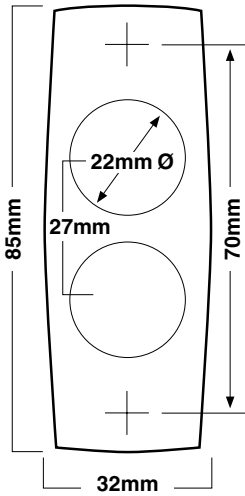

**32A
32**

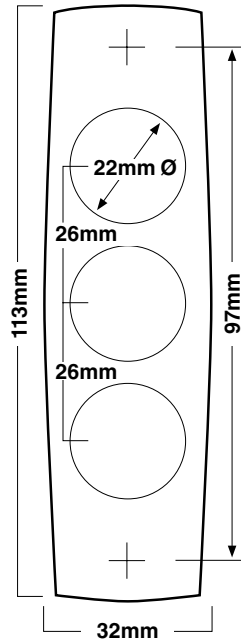

**33A
33**

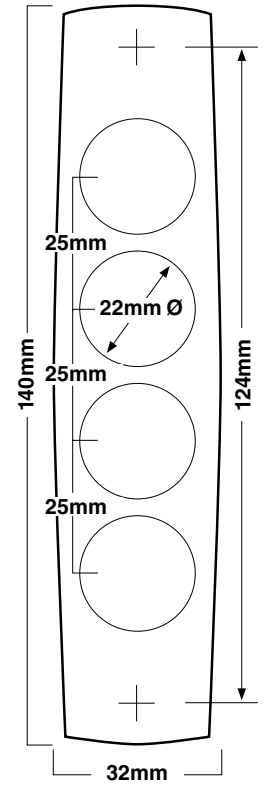

**34A
34**

**STANDARD SIZE SWITCHPLATES
- MOUNTING TEMPLATES**

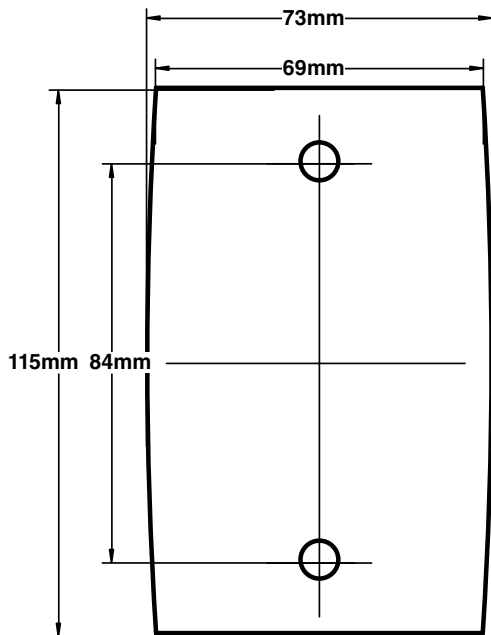

**Maximum
Cut-Out Size**

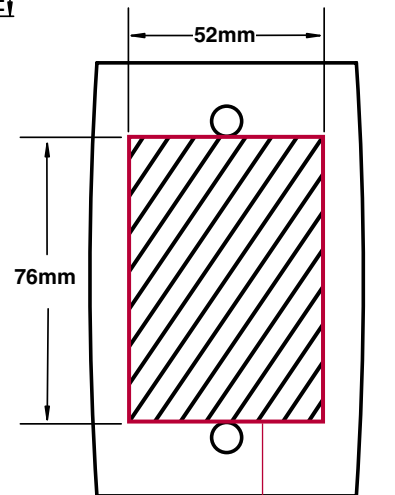

**MAXIMUM
CLEARANCE
AREA**

STANDARD RANGE QUICK REFERENCE GUIDE

CLIPSAL
ELECTRICAL ACCESSORIES



STANDARD RANGE QUICK REFERENCE GUIDE



CLIPSAL
ELECTRICAL ACCESSORIES

Product of Clipsal Australia Pty Ltd
NSW 151 307 873 105

Head Office:
12 Park Terrace, Bowdler
South Australia 5007
Telephone (08) 8269 0511
Facsimile (08) 8340 1724
Internet clipsal.com
E-Mail plugin@clipsal.com

Offices in all States:

NSW: Sydney
Albury

VIC: Melbourne

3000
1 2377
3000
603 893

3044 7444
4720 3333
0948 0400
0942 8444

0943 0900
0847 0278
0641 3377

CLIPSAL
every room, every home

Setting the
Standard
**STANDARD
SERIES**

No other range
is up to Standard.

STANDARD RANGE QUICK REFERENCE GUIDE

STANDARD SIZE FLUSH SWITCHES - 250V/10A, HORIZONTAL MOUNTING, 1 WAY/2 WAY						
Cat No	Description	Length	Width	Depth	Mounting Centres	PAGE
31HA	1 Gang Switch.	115mm	73mm	11mm	84mm apart	13
32HA	2 Gang Switch.	115mm	73mm	11mm	84mm apart	13
33HA	3 Gang Switch.	115mm	73mm	11mm	84mm apart	13
34HA	4 Gang Switch.	115mm	73mm	11mm	84mm apart	13
STANDARD SIZE FLUSH SWITCHES - 250V/10A, VERTICAL MOUNTING, 1 WAY/2 WAY						
31VA	1 Gang Switch.	115mm	73mm	11mm	84mm apart	13
32VA	2 Gang Switch.	115mm	73mm	11mm	84mm apart	13
33VA	3 Gang Switch.	115mm	73mm	11mm	84mm apart	13
34VA	4 Gang Switch.	115mm	73mm	11mm	84mm apart	13
35VA	5 Gang Switch.	115mm	73mm	11mm	84mm apart	13
36VA	6 Gang Switch.	115mm	73mm	11mm	84mm apart	13
ARCHITRAVE SIZE FLUSH SWITCHES - 250V						
30	1 Gang Switch, 10A, 1 way/2 way.	75mm	32mm	10mm	55mm apart	14
30D	1 Gang Switch, 10A, 1 way, double pole.	75mm	32mm	10mm	55mm apart	14
30/15	1 Gang Switch, 15A, 1 way/2 way.	75mm	32mm	10mm	55mm apart	14
30D15	1 Gang Switch, 15A, 1 way, double pole.	75mm	32mm	10mm	55mm apart	14
39	1 Gang Switch, 10A, 1 way/2 way, 3 position - Low/OFF/High.	75mm	32mm	33mm	54.3mm apart	14
30DD	1 Gang Switch, 10A, 1 way, double pole, deep plate.	77mm	32mm	18mm	55mm apart	14
32A	2 Gang Switch, 10A, 1 way/2 way.	85mm	32mm	10mm	70mm apart	14
33A	3 Gang Switch, 10A, 1 way/2 way.	113mm	32mm	10mm	97mm apart	14
34A	4 Gang Switch, 10A, 1 way/2 way.	140mm	32mm	10mm	124mm apart	14
MINIATURE ARCHITRAVE SWITCHES - 250V/10A, 1 WAY/2 WAY						
30T	1 Gang Switch.	54mm	27mm	10mm	40mm apart	14
32TA	2 Gang Switch.	75mm	27mm	10mm	60mm apart	14
33TA	3 Gang Switch.	98mm	27mm	10mm	83mm apart	14
INTERMEDIATE SIZE SWITCHES - 250V/10A, 1 WAY/2 WAY (94mm x 48mm at centre)						
31BA	1 Gang Switch.	95mm	48mm	10mm	55mm apart	15
32BA	2 Gang Switch.	95mm	48mm	10mm	55mm apart	15
31BLA	1 Gang Switch.	95mm	48mm	10mm	78mm apart	15
32BLA	2 Gang Switch.	95mm	48mm	10mm	78mm apart	15
LARGE FORMAT SIZE FLUSH SWITCHES - 250V/10A, 1 WAY/2 WAY, VERTICAL MOUNTING						
31/2VA	1 Gang Switch.	116mm	116mm	11mm	84 x 46mm	15
32/2VA	2 Gang Switch.	116mm	116mm	11mm	84 x 46mm	15
33/2VA	3 Gang Switch.	116mm	116mm	11mm	84 x 46mm	15
34/2VA	4 Gang Switch.	116mm	116mm	11mm	84 x 46mm	15
35/2VA	5 Gang Switch.	116mm	116mm	11mm	84 x 46mm	15
36/2VA	6 Gang Switch.	116mm	116mm	11mm	84 x 46mm	15
37/2VA	7 Gang Switch.	116mm	116mm	11mm	84 x 46mm	15
38/2VA	8 Gang Switch.	116mm	116mm	11mm	84 x 46mm	15
39/2VA	9 Gang Switch.	116mm	116mm	11mm	84 x 46mm	15
STANDARD SIZE FLUSH PLATES						
31VH	1 Gang.	115mm	73mm	11mm	84mm apart	16
32VH	2 Gang.	115mm	73mm	11mm	84mm apart	16
33VH	3 Gang.	115mm	73mm	11mm	84mm apart	16
34VH	4 Gang.	115mm	73mm	11mm	84mm apart	16
35VH	5 Gang.	115mm	73mm	11mm	84mm apart	16
36VH	6 Gang.	115mm	73mm	11mm	84mm apart	16
31VX	Blank Flush Plate.	115mm	73mm	11mm	84mm apart	16
31VXCB	Blank Flush Plate. With 30A terminal block.	115mm	73mm	11mm	84mm apart	16

STANDARD RANGE QUICK REFERENCE GUIDE (Continued)

ARCHITRAVE SIZE FLUSH PLATES						
Cat No	Description	Length	Width	Depth	Mounting Centres	PAGE
31	1 Gang.	75mm	32mm	11mm	55mm apart	16
31D	1 Gang, deep.	75mm	32mm	18mm	55mm apart	16
32	2 Gang.	86mm	32mm	11mm	70mm apart	16
33	3 Gang.	112mm	32mm	11mm	97mm apart	16
34	4 Gang.	140mm	32mm	11mm	124mm apart	16
MINIATURE ARCHITRAVE SIZE FLUSH PLATES						
31T	1 Gang.	54mm	27mm	10mm	40mm apart	17
32T	2 Gang.	75mm	27mm	10mm	60mm apart	17
33T	3 Gang.	98mm	27mm	10mm	83mm apart	17
INTERMEDIATE SIZE FLUSH PLATES						
31B	1 Gang.	95mm	48mm	10mm	55mm apart	17
32B	2 Gang.	95mm	48mm	10mm	55mm apart	17
31BL	1 Gang, with large mounting centres.	95mm	48mm	10mm	78mm apart	17
32BL	1/2 Gang, with large mounting centres.	95mm	48mm	10mm	78mm apart	17
LARGE FORMAT SIZE FLUSH PLATES - VERTICAL MOUNTING						
31/2V	1 Gang.	116mm	116mm	11mm	84mm x 46mm	17
32/2V	2 Gang.	116mm	116mm	11mm	84mm x 46mm	17
33/2V	3 Gang.	116mm	116mm	11mm	84mm x 46mm	17
34/2V	4 Gang.	116mm	116mm	11mm	84mm x 46mm	17
35/2V	5 Gang.	116mm	116mm	11mm	84mm x 46mm	17
36/2V	6 Gang.	116mm	116mm	11mm	84mm x 46mm	17
37/2V	7 Gang.	116mm	116mm	11mm	84mm x 46mm	17
38/2V	8 Gang.	116mm	116mm	11mm	84mm x 46mm	17
39/2V	9 Gang.	116mm	116mm	11mm	84mm x 46mm	17
31/2VX	2 Gang Blank Flush Plate.	116mm	116mm	11mm	84mm x 46mm	17
31/3VX	3 Gang Blank Flush Plate.	162mm	115mm	11mm	84mm x 46mm	17
SKIRTING SIZE FLUSH PLATES						
31BMF	1 Gang.	99mm	45mm	18mm	78mm apart	18
32BMF	2 Gang.	99mm	45mm	18mm	78mm apart	18
35BMF	5 Gang.	156mm	45mm	18mm	136mm apart	18
JUNCTION BOX MOUNTED FLUSH PLATE						
31VR	Round Plate, suits J-Box Mounting (70mm diameter).	70mm Ø		24mm	50mm	18
TELEPHONE / DATA OUTLET PLATE						
31VRJ	Data Outlet Plate, with Cat 3 RJ45 socket.	115mm	73mm	11mm	84mm	18
IP54 RATED WEATHERPROOF FLUSH SWITCH						
31VHWP	1 Gang Weatherproof Switch Plate, (IP54 rated).	115mm	73mm	11mm	84mm apart	18
C-THRU® LIGHT DIMMERS						
32E450L	C-Thru® Light Dimmer, Leading Edge, 220-240V/450W.	115mm	73mm	11mm - plate 13mm - knob 30mm - wall recess	84mm apart	20
32E450T	C-Thru® Light Dimmer, Trailing Edge, 220-240V/450W.	115mm	73mm	11mm - plate 13mm - knob 30mm - wall recess	84mm apart	20
32E450LM	C-Thru® Light Dimmer Mechanism, Leading Edge, 220-240V/450W.	22mm	22mm	13mm - plate 41mm - wall recess	N/A	20
32E450TM	C-Thru® Light Dimmer Mechanism, Leading Edge, 220-240V/450W.	22mm	22mm	13mm - plate 41mm - wall recess	N/A	20
HIGH POWER SERIES LIGHT DIMMERS						
31E800T	Trailing Edge Light Dimmer, 250V/800VA (suits electronic transformers).	115mm	73mm	15mm - plate 11mm - knob 30mm - wall recess	84mm apart	20
31E1000L	Leading Edge Light Dimmer, 250V/1000VA (suits incandescent & iron core trans.).	115mm	73mm	15mm - plate 11mm - knob 30mm - wall recess	84mm apart	20
32/1000	Incandescent & Low Voltage Remote Light Dimmer, 250V/1000VA.	115mm	73mm	11mm - plate 13mm - knob 30mm - wall recess	84mm apart	20
32/2400	Incandescent & Low Voltage Remote Light Dimmer, 250V/2400VA.	115mm	73mm	11mm - plate 13mm - knob 30mm - wall recess	84mm apart	20

STANDARD RANGE QUICK REFERENCE GUIDE (Continued)

FILTER MODULE						
Cat No	Description	Length	Width	Depth	Mounting Centres	PAGE
32EIND	Inductor Filter Module, for use with electronic transformers	96mm	70mm	48mm	73mm apart	20
C-THRU® FAN SPEED CONTROLLER						
32E500F	C-Thru® Fan Controller, 220-240V/500W.	115mm	73mm	11mm - plate 13mm - knob 30mm - wall recess	84mm apart	20
32E500FM	C-Thru® Fan Controller Mechanism, 220-240V/500W.	22mm	22mm	13mm - plate 41mm - wall recess	N/A	20
FAN SPEED CONTROLLER FOR "AIRFLOW" ACES36AL & ACES48AL						
31VF3CA	3 Speed Fan Controller, 100VA, suitable for use with Airflow ACES36AL & ACES48AL.	115mm	73mm	11mm - plate 14mm - knob 40mm - wall recess	84mm apart	21
31VF3CB	3 Speed Fan Controller, 100VA, suitable for Airflow ACES56AL and AFLR48.	115mm	73mm	11mm - plate 14mm - knob 40mm - wall recess	84mm apart	21
ELECTRONIC TIMER CONTROLS - 250V/10A						
31VETR	254 minutes, 2 wire.	115mm	73mm	11mm	84mm apart	21
31VETR3	15 hours, 3 wire.	115mm	73mm	11mm	84mm apart	21
31VETF	10 minutes, fans/lights.	115mm	73mm	11mm	84mm apart	21
PNEUMATIC TIME DELAY SWITCHES						
319	Time Delay Switch.	115mm	73mm	11mm	84mm apart	22
319RA	Time Delay Switch, reverse action.	115mm	73mm	11mm	84mm apart	22
319N	Time Delay Switch with Neon.	115mm	73mm	11mm	84mm apart	22
319HP	Time Delay Switch, Weatherproof/Hose Proof.	115mm	73mm	11mm	84mm apart	22
319X	Time Delay Switch with Extra Switch.	115mm	73mm	11mm	84mm apart	22
ANALOGUE TIMER CONTROLS						
TC15/24	24 Hour Timer, Single Power Outlet, 250V/10A (with safety shutter).	121mm	79mm	42mm	84mm apart	22
TC15/15/24	24 Hour Timer, Single Socket Outlet, 250V/15A (with safety shutter).	121mm	79mm	42mm	84mm apart	22
TC15/15/7D	7 Day Timer, Single Power Outlet, 250V/15A (with safety shutter).	121mm	79mm	42mm	84mm apart	22
TC32V1	1 Hour Timer, Flush Switch, 250V/15A.	115mm	73mm	62mm	84mm apart	22
TC32V24	24 Hour Timer, Flush Switch, 250V/15A.	115mm	73mm	62mm	84mm apart	22
TC32V7D	7 Day Timer, Flush Switch, 250V/15A.	115mm	73mm	62mm	84mm apart	22
TC475/24	24 Hour Timer, Portable Dual Switch Socket.	160mm	130mm	120mm	N/A	22
SUNSET SWITCH						
31VSSR	Sunset Switch, 250V/10A, 16 hours, 2 wire, IP56 (standard size).	115mm	74mm	50mm	84mm apart	23
BOOSTER ELEMENT RELAY						
31VBER	Booster Relay for Solar Hot Water Element, 250V/15A.	115mm	73mm	plate - 16mm button - 4.5 wall recess - 29mm	84mm apart	23
SWITCH MULTIPLIERS						
780/1	Switch Multiplier, 250V/10A, 1 way.	96mm	70mm	48mm	73mm apart	23
780/2	Switch Multiplier, 250V/10A, 2 way.	96mm	70mm	48mm	73mm apart	23
780K1	Switch Multiplier, 250V/10A, 1 way (with 2 gang architrave switch assembly).	96mm	70mm	48mm	73mm apart	23
780K2	Switch Multiplier Mechanism, 250V/10A, 2 way.	96mm	70mm	48mm	73mm apart	23
780M	Switch Multiplier Mechanism, 250V/10A.	N/A	N/A	N/A	N/A	23
780A2M	Switch Multiplier Mechanism (suits 2 loads 2 way type A bias).	N/A	N/A	N/A	N/A	23
780B2M	Switch Multiplier Mechanism (suits 2 loads 2 way type B bias).	N/A	N/A	N/A	N/A	23
UNDER VOLTAGE RELAYS						
15X15RZ	Single Power Outlet, 250V/15A (with no volt relay and reset switch).	115mm	73mm	11mm	84mm apart	24
15XRZ	Single Power Outlet, 250V/10A (with no volt relay and reset switch).	115mm	73mm	11mm	84mm apart	24
32VRZ	No Volt Relay and Reset Switch, 250V/10A (standard size).	115mm	73mm	11mm	84mm apart	24
32VRZ15	No Volt Relay and Reset Switch, 250V/15A (standard size).	115mm	73mm	11mm	84mm apart	24

KEY TAG TYPE SWITCHES - 250V a.c.						
Cat No	Description	Length	Width	Depth	Mounting Centres	PAGE
36VKT3N	Key Tag Switch, suits 3x20A, 1/2way circuit with neon.	115mm	73mm	11mm	84mm apart	25
36VKT3NX	Key Tag Switch, suits 3x20A, 1/2way circuit, neon, extra 250V a.c. 10A switch mech.	115mm	73mm	11mm	84mm apart	25
36VKT4	Key Tag Type Switch, suits 4x20A, 1/2way circuits.	115mm	73mm	11mm	84mm apart	25
36VKT4X	Key Tag Type Switch, suits 4x20A, 1/2way circuits, extra 10A 250V a.c. switch mech.	115mm	73mm	11mm	84mm apart	25
KEY TAG ONLY						
35VKT	Key Tag, suits 35VKT series switches.	120mm	45mm	5mm	N/A	25
2034VKT	Short Key Tag, suits 2034VKT series switches.	92mm	40mm	7mm	N/A	25
KEY OPERATED SWITCHES - 250V, 20A/16AX						
31VK1	Key Operated Switch, 1 way (locks in Off position).	115mm	73mm	11mm	84mm apart	25
31VK1/2	Key Operated Switch, 2 way (locks in Off position).	115mm	73mm	11mm	84mm apart	25
31VK2	Key Operated Switch, 1 way (locks in On and Off position).	115mm	73mm	11mm	84mm apart	25
31VK2/2	Key Operated Switch, 2 way (locks in On and Off position).	115mm	73mm	11mm	84mm apart	25
COMMON KEYED SWITCHES						
31VK1CK	Key Operated Switch, 250V 20A/16AX, 1 way (locks in Off position).	115mm	73mm	11mm	84mm apart	25
31VK1/2CK	Key Operated Switch, 250V 20A/16AX, 2 way (locks in Off position).	115mm	73mm	11mm	84mm apart	25
31VK2CK	Key Operated Switch, 250V 20A/16AX, 1 way (locks in On and Off position).	115mm	73mm	11mm	84mm apart	25
31VK2/2CK	Key Operated Switch, 250V 20A/16AX, 2 way (locks in On and Off position).	115mm	73mm	11mm	84mm apart	25
CEILING SWITCHES						
306	Ceiling Switch, 250V/15A, 1 way.	52mm Ø	71mm	39mm		26
342	Ceiling Switch, 250V/10A, 1 way.	52mm Ø	71mm	39mm		26
343	Ceiling Switch, 250V/10A, 2 way.	52mm Ø	71mm	39mm		26
346	Ceiling Switch, 250V/15A, 1 way.	52mm Ø	71mm	39mm		26
WILCO CEILING SWITCH						
PC1	Ceiling Switch, pull cord, 10A, double pole with indicator.	57mm	45mm	18mm	30mm x 28mm	26
FOOT OPERATED SWITCH						
360	Foot Operated Switch, 250V/10A, double pole.	93mm	55mm	29mm	68 x 18mm apart	26
AMERICAN STYLE FLUSH SWITCHES AND PLATES - INDIRECT MOUNTING						
321	1 Gang Switch Plate.	115mm	70mm	8mm	60mm apart	27
321R	Switch Plate, suits one socket.	115mm	70mm	8mm	60mm apart	27
322/1R	Switch Plate, suits 1 switch and 1 socket.	116mm	116mm	8mm	60 x 46mm	27
320	Switch Mechanism, 250V a.c./10A, 1 way.	93mm	35mm		84mm apart	27
320/15	Switch Mechanism, 250V a.c./15A, 1 way.	93mm	35mm		84mm apart	27
DC3	Flush Switch, 5A, 3 terminal, 1 way, d.c. (with mounting lugs).	93mm	35mm	36mm	84mm apart	27
DC3-SPDT	Flush Switch, 5A, 3 terminal, single pole/double throw, d.c. (with mounting lugs).	93mm	35mm	36mm	84mm apart	27
WSW110	Flush Switch, 10A, 1 way.	93mm	35mm	32mm	84mm apart	27
WSW110/TW	Flush Switch, 10A, 2 way.	93mm	35mm	32mm	84mm apart	27
WSW116	Flush Switch, 16A, 1 way.	93mm	35mm	32mm	84mm apart	27
WSW116/TW	Flush Switch, 16A, 2 way.	93mm	35mm	32mm	84mm apart	27
FS169/1	Flush Switch, 10A, intermediate (with mounting lugs).	93mm	35mm	22mm	84mm apart	27
FS169/15DPDT	Flush Switch, 15A, intermediate, double pole/double throw (with mounting lugs).	93mm	35mm	22mm	84mm apart	27
WILCO SURFACE SWITCH						
SS165/15/2	Surface Switch, 15A, 2 way, 3 terminal, screw secured cover (52mm diameter).	52mm Ø		17mm	36mm apart	28
SURFACE SWITCHES - 250V						
362	Surface Switch, 10A, 1 way, 3 terminal.	60mm Ø		19mm	48mm apart	28
362/15	Surface Switch, 15A, 1 way, 3 terminal.	60mm Ø		19mm	48mm apart	28
363	Surface Switch, 10A, 2 way, 4 terminal.	60mm Ø		19mm	48mm apart	28
389	Surface Switch, 25A a.c., 32V d.c., 1 way.	61mm Ø		27mm	43mm apart	28
BELL PRESS						
98	Bell Press, illuminated.	60mm	25mm	19mm	48mm apart	28

STANDARD RANGE QUICK REFERENCE GUIDE (Continued)

WILCO PUSH BUTTON SWITCHES - WITH COLLAR AND LOCKNUT						
Cat No	Description	Length	Width	Depth	Mounting Centres	PAGE
PBS136	2A, single pole.	28mm	15mm	28mm (Room protrusion - 18mm)	N/A	28
PBS236	2A double pole.	28mm	15mm	34mm (Room protrusion - 18mm)	N/A	28
PUSH BUTTON WEATHERPROTECTED 1P53 SURFACE SWITCHES - 1 GANG, SINGLE POLE						
WPBSW110	10A, 1 way/2 way.	60mm	35mm	32mm		28
WPBSW116	16A, 1 way/2 way.	60mm	35mm	32mm		28
CIRCUIT IDENTIFICATION PRODUCTS						
30P	Removable Blank Plug, suits 30 series.	21mm	21mm	10mm		29
30PFO	Plug, marked "FRIDGE - FREEZER ONLY".	21mm	21mm	10mm		29
30PID	30 Series ID Circuit Plug, tamper proof.	21mm	21mm	7mm		29
30PIDA4L	Label Sheets, 10 x A4 packet (RD, BU, GR, YL, WE colours available).	N/A	N/A	N/A	N/A	29
9	Cap, suits switch plate screw recesses.	8mm Ø		5mm	N/A	29
9SERIES	Identi, caps for circuit identification.	8mm Ø		5mm	N/A	29
MOUNTING ACCESSORIES						
ET30	Screw Mounting Earthing Terminal.	6mm	N/A	N/A	N/A	29
B30GFZ	Mounting Clip with Moulded Surround.	45mm	27mm	11mm	24mm apart	29
F30Z1	Mounting Clip Mechanism, suits 1mm thick sheet.	29mm	29mm	N/A	N/A	29
F30Z1.5	Mounting Clip Mechanism, suits 1.5mm thick sheet.	29mm	29mm	N/A	N/A	29
F30Z2	Mounting Clip Mechanism, suits 2mm thick sheet.	29mm	29mm	N/A	N/A	29
F30Z4	Mounting Clip Mechanism, suits 4m thick sheet.	29mm	29mm	N/A	N/A	29
31/3F	Three Gang Mounting Flange.	162mm	116mm	11mm	92mm apart	29
CABLE CONNECTION ACCESSORIES						
31VXCB	Blank Plate with 30A Connector Block.	115mm	73mm	11mm	84mm apart	30
32VA15/38TB	30M15 Mech and 38TB Terminal Block in Standard Size Plate.	115mm	73mm	11mm	84mm apart	30
38	Grommet, suits up to 2.5mm ² ordinary duty flex cord.	22mm Ø			N/A	30
38A	Grommet, suits up to 1.5mm ² ordinary duty flex cord.	22mm Ø			N/A	30
38X	Grommet, suits up to 1mm ² ordinary duty flex cord.	22mm Ø			N/A	30
38Y	Grommet, suits figure 8 two core flex cord.	22mm Ø			N/A	30
38Z	Grommet, suits up to 0.75mm ² light duty flex cord.	22mm Ø			N/A	30
38HD	Grommet, suits up to 2.5mm ² ordinary duty with clamp.	25mm	21mm	30mm	N/A	30
38TB	Cord Outlet Terminal Block with Grommet, suits 30 Series plates.	32mm	22mm		N/A	30
PROTECTED SWITCH - 250V, MOULDED, 1 WAY/2 WAY						
PSM110	10A.	75mm	46mm	51mm	69mm apart	31
PSM115	15A.	75mm	46mm	51mm	69mm apart	31
PROTECTED SWITCHES - 250V, 10A, ZINC DIE CAST						
PS110	Single pole.	79mm	51mm	50mm	37mm apart	31
PS110-DC	Single pole, d.c. operation.	79mm	51mm	50mm	37mm apart	31
PS110-DP	Double pole.	79mm	51mm	50mm	37mm apart	31
PS110-I	Single pole, intermediate.	79mm	51mm	50mm	37mm apart	31
PS110-N	Single pole, with neon.	79mm	51mm	50mm	37mm apart	31
PS110-TW	Single pole, 2 way.	79mm	51mm	50mm	37mm apart	31
PS110-2	Single pole, two gang.	101mm	79mm	50mm	82mm apart	31
PS110-2DP	Double pole, two gang.	101mm	79mm	50mm	82mm apart	31
PS1102I	Single pole, two gang, intermediate.	101mm	79mm	50mm	82mm apart	31
PROTECTED SWITCHES - 250V, 16A, ZINC DIE CAST, SINGLE POLE						
PS116	Single pole.	80mm	51mm	50mm	38mm apart	31
PS116/TW	Two gang.	80mm	51mm	50mm	38mm apart	31
PS116/2	2 way.	101mm	80mm	50mm	82mm apart	31

STANDARD RANGE QUICK REFERENCE GUIDE (Continued)

STANDARD SIZE SINGLE AUTOMATICALLY SWITCHED SOCKET OUTLETS - HORIZONTALLY MOUNTED						
Cat No	Description	Length	Width	Depth	Mounting Centres	PAGE
10	10A, single pole.	115mm	73mm	16mm	84mm apart	33
10D	10A, double pole.	115mm	73mm	16mm	84mm apart	33
10DS	10A, double pole with safety shutters.	115mm	73mm	16mm	84mm apart	33
10DN	10A, double pole with safety shutters & neon.	115mm	73mm	16mm	84mm apart	33
10DLS	10A, round earth, double pole with safety shutter.	115mm	73mm	16mm	84mm apart	33
10D15S	15A, double pole with safety shutter.	115mm	73mm	16mm	84mm apart	33
10DWP	10A, double pole flush weather proof.	93mm	82mm	12mm	70 x 54mm	33
10DWP15	15A, double pole flush weather proof.	93mm	82mm	12mm	70 x 54mm	33
415VF	10A, double pole with flap, IP34 rating.	101mm	80mm	37mm	76 x 65mm	33
415VF15	15A, double pole with flap, IP34 rating.	101mm	80mm	37mm	76 x 65mm	33
10PL	10A, single pole with security flap.	115mm	73mm	22mm	84mm apart	33
STANDARD SIZE TWIN AUTOMATICALLY SWITCHED SOCKET OUTLETS - 10A, HORIZONTALLY MOUNTED						
20	Single pole.	115mm	73mm	16mm	84mm apart	34
20D	Double pole.	115mm	73mm	16mm	84mm apart	34
20DS	Double pole with safety shutters.	115mm	73mm	16mm	84mm apart	34
20DN	Double pole with safety shutters & neons.	115mm	73mm	16mm	84mm apart	34
20DLS	Round earth, double pole & safety shutters.	115mm	73mm	16mm	84mm apart	34
SKIRTING MOUNTED SINGLE AUTOMATICALLY SWITCHED SOCKET OUTLET						
11	Single Auto Switched Socket Outlet, skirting mounted, 10A, single pole, 99 x 45mm at centre.	95mm	45mm	17mm	78mm apart	34
SKIRTING MOUNTED TWIN AUTOMATICALLY SWITCHED SOCKET OUTLETS - 10A						
11/2	Single pole.	125mm	50mm	17mm	104mm apart	34
11/2MF	Single pole to suit ducting.	125mm	50mm	17mm	104mm apart	34
11/2MFN	Single pole, safety shutters, neons, suits ducting.	125mm	50mm	17mm	104mm apart	34
AUTOMATICALLY SWITCHED SOCKET OUTLETS - SINGLE						
10M	10A, single pole.	97mm	43mm	29mm	84mm apart	35
10MD	10A, double pole.	97mm	43mm	29mm	84mm apart	35
10MDS	10A, double pole with safety shutter.	97mm	43mm	29mm	84mm apart	35
10MDLS	10A, round earth, double pole with safety shutter.	97mm	43mm	29mm	84mm apart	35
10MD15S	15A, double pole with shutter.	97mm	43mm	29mm	84mm apart	35
10MD20	20A, double pole.	97mm	43mm	29mm	84mm apart	35
SPECIAL PURPOSE AUTOMATICALLY SWITCHED SOCKET OUTLETS						
10MP	Single Auto Switched Socket Outlet Mechanism, 10A, single pole. Fascia - 42mm Ø.	42mm	43mm	33mm (Room protrusion - 3.5mm)	See mounting detail Pg. 38	35
10MDP	Single Auto Switched Socket Outlet Mechanism, 10A, double pole. Fascia - 42mm Ø.	42mm	43mm	33mm (Room protrusion - 3.5mm)	See mounting detail Pg. 38	35
10MDPL	Single Auto Switched Socket Outlet Mechanism, 10A, round earth, double pole. Fascia - 42mm Ø.	42mm	43mm	33mm (Room protrusion - 3.5mm)	See mounting detail Pg. 38	35
10MDP15	Single Auto Switched Socket Outlet Mechanism, 15A, double pole. Fascia - 42mm Ø.	42mm	43mm	33mm (Room protrusion - 3.5mm)	See mounting detail Pg. 38	35
10MDLB	Single Auto Switched Socket Outlet Mechanism, 10A, double pole.	60mm	42mm	33mm	50mm apart	36
10MDSLB	Single Auto Switched Socket Outlet Mechanism, 10A, double pole with safety shutter.	60mm	42mm	33mm	50mm apart	36
10MDLSLB	Single Auto Switched Socket Outlet Mechanism, round earth, double pole, safety shutter.	60mm	42mm	33mm	50mm apart	36
10MD15SLB	Single Auto Switched Socket Outlet Mechanism, 15A, double pole with safety shutter.	60mm	42mm	33mm	50mm apart	36
10MD20LB	Single Auto Switched Socket Outlet Mechanism, 20A, double pole.	60mm	42mm	33mm	50mm apart	36
G10MDS	GEC Miniplug Mechanism, 10A, double pole with safety shutter.	46mm	46mm	34mm	N/A	36
G10FMDS	GEC AF Series Mechanism, 10A, double pole with safety shutter.	74mm Ø		31mm	64mm apart	36
G10FMD15S	GEC AF Series Mechanism, 15A, double pole with safety shutter.	74mm Ø		31mm	64mm apart	36
G10FMDLS	GEC AF Series Mechanism, 10A, round earth with safety shutter.	74mm Ø		31mm	64mm apart	36
SKIRTING MOUNTED SIDE CONNECTING SOCKET OUTLETS - 250V/10A, SINGLE POLE						
12M	Single Auto Switched Socket Outlet.	63mm	43mm	29mm	N/A	37
17M	Single Auto Switched Socket Outlet.	90mm	43mm	29mm	N/A	37
STANDARD SIZE SINGLE TOGGLE SWITCHED SOCKET OUTLETS - 250V/20A, HORIZONTALLY MOUNTED						
42/20	Single Switched Socket Outlet, toggle switch, single pole.	115mm	70mm	15mm	84mm apart	37
42/20N	Single Switched Socket Outlet, toggle switch, single pole with safety shutter & neon.	115mm	70mm	15mm	84mm apart	37
SINGLE TOGGLE NARROW ARCHITRAVE SIZE SWITCHED SOCKET OUTLETS - 250V/10A, VERTICALLY MOUNTED						
40	Single pole.	115mm	48mm	15mm	98mm apart	37
40D	Double pole.	115mm	48mm	15mm	98mm apart	37

STANDARD RANGE QUICK REFERENCE GUIDE (Continued)

UNSWITCHED SOCKET OUTLETS- SINGLE						
Cat No	Description	Length	Width	Depth	Mounting Centres	PAGE
405	250V/10A, 2 pin parallel.	96mm	42mm	33mm (Room protrusion - 3.5mm)	84mm apart	38
405/32	32V/15A, 2 pin polarised, extra low voltage.	96mm	42mm	33mm (Room protrusion - 3.5mm)	84mm apart	38
415	250V/10A, 3 pin.	96mm	42mm	33mm (Room protrusion - 3.5mm)	84mm apart	38
415L	250V/10A, 3pin, round earth pin.	96mm	42mm	33mm (Room protrusion - 3.5mm)	84mm apart	38
415/110	110V/10A, 3 pin, 2 round live pins.	96mm	42mm	33mm (Room protrusion - 3.5mm)	84mm apart	38
415/15	250V/15A, 3 pin.	96mm	42mm	33mm (Room protrusion - 3.5mm)	84mm apart	38
415MP	250V/10A, 3 pin, panel mount.	43mm	42mm	33mm (Room protrusion - 3.5mm)	See mounting detail Pg. 38	38
415MP15	250V/15A, 3 pin, panel mount.	43mm	42mm	33mm (Room protrusion - 3.5mm)	See mounting detail Pg. 38	38
415MPL	S250V/10A, 3 pin, round earth, panel mount.	43mm	42mm	33mm (Room protrusion - 3.5mm)	See mounting detail Pg. 38	38
426	250V/10A, 3 pin, suits round J-Box.	66mm Ø		24mm	50mm apart	38
426L	250V/10A, 3 pin, round earth pin, suits round J-Box.	66mm Ø		24mm	50mm apart	38
426/15	250V/15A, 3 pin, suits round J-Box.	66mm Ø		24mm	50mm apart	38
WILCO SOCKET OUTLETS (GREY ONLY) - SINGLE						
FOS106	250V/10A, 3 flat pins.	96mm	42mm	28mm	84mm apart	39
FOS106R	250V/10A, 3 pins, round earth pin.	96mm	42mm	28mm	84mm apart	39
FOS106/2R	110V/10A, 3pins, 2 round live pins.	96mm	42mm	28mm	84mm apart	39
FOS106/15	250V/15A, 3 flat pins.	96mm	42mm	28mm	84mm apart	39
FOS105T	2 flat polarised, extra low voltage.	96mm	42mm	28mm	84mm apart	39
ELECTRIC CLOCK CONNECTION ACCESSORIES - 250V						
408/3	Clock Point Recessed Socket, 15A, 50Hz, 3 pin.	106mm	59mm	25mm	84mm apart	39
408/3A	Clock Point Recessed Socket, 3 pin, suitable for other than 50Hz.	106mm	59mm	25mm	84mm apart	39
408/4	Clock Point Recessed Socket, 5A, 4 pin.	106mm	59mm	25mm	84mm apart	39
409/3	Clock Point Plug, 5A, 50Hz, 3 pin.	48mm	35mm	11mm	N/A	39
409/3A	Clock Point Plug, 3 pin, suitable for other than 50Hz.	48mm	35mm	11mm	N/A	39
409/4	Clock Point Plug, 5A, 50Hz, 4 pin.	48mm	35mm	11mm	N/A	39
STANDARD SIZE SINGLE SWITCHED SOCKET OUTLETS - 250V, HORIZONTALLY MOUNTED						
15	10A.	115mm	73mm	14mm	84mm apart	41
15S	10A with safety shutter.	115mm	73mm	14mm	84mm apart	41
15N	10A with safety shutter and neon.	115mm	73mm	14mm	84mm apart	41
15D	10A, double pole.	115mm	73mm	14mm	84mm apart	41
15D15	15, double pole.	115mm	73mm	14mm	84mm apart	41
15DN	S10A, double pole, with safety shutter & neon.	115mm	73mm	14mm	84mm apart	41
15DD	10A, double pole, deep plate.	115mm	73mm	33mm	84mm apart	41
15DX	10A, double pole with extra switch.	115mm	73mm	14mm	84mm apart	41
15/15	15A.	115mm	73mm	14mm	84mm apart	41
15/15S	15A with safety shutter.	115mm	73mm	14mm	84mm apart	41
15/15N	15A with safety shutter and neon.	115mm	73mm	14mm	84mm apart	41
15L	10A, round earth pin.	115mm	73mm	14mm	84mm apart	41
15LN	10A, round earth pin with safety shutter and neon.	115mm	73mm	14mm	84mm apart	41
15X	S10A with extra switch.	115mm	73mm	14mm	84mm apart	41
15XS	10A with extra switch and safety shutter.	115mm	73mm	14mm	84mm apart	41
15XN	10A with extra switch, safety shutter and neon.	115mm	73mm	14mm	84mm apart	41
15XX	10A with two extra switches.	115mm	73mm	14mm	84mm apart	41
STANDARD SIZE TWIN SWITCHED SOCKET OUTLETS - 250V, HORIZONTALLY MOUNTED						
25	10A.	115mm	73mm	16mm	84mm apart	42
25S	10A with safety shutters.	115mm	73mm	16mm	84mm apart	42
25N	10A with safety shutters and neons.	115mm	73mm	16mm	84mm apart	42
25D	10A, double pole.	115mm	73mm	16mm	84mm apart	42
25D15	15A, double pole.	115mm	73mm	16mm	84mm apart	42
25/15	15A.	115mm	73mm	16mm	84mm apart	42
25/15S	15A with safety shutters.	115mm	73mm	16mm	84mm apart	42
25/15N	15A with safety shutters and neons.	115mm	73mm	16mm	84mm apart	42

STANDARD RANGE QUICK REFERENCE GUIDE (Continued)

STANDARD SIZE TWIN SWITCHED SOCKET OUTLETS - 250V, HORIZONTALLY MOUNTED (continued)						
Cat No	Description	Length	Width	Depth	Mounting Centres	PAGE
25/1510	15 & 10A.	115mm	73mm	16mm	84mm apart	42
25L	10A, round earth pin.	115mm	73mm	16mm	84mm apart	42
25X	10A, with extra one way switch.	115mm	73mm	16mm	84mm apart	42
25XS	10A, extra one way switch and shutters.	115mm	73mm	16mm	84mm apart	42
MF25X	10A, marked with "FAN" on extra switch.	115mm	73mm	16mm	84mm apart	42
ML25X	10A, marked with "LIGHT" on extra switch.	115mm	73mm	16mm	84mm apart	42
25XA	10A with removable extra switch.	115mm	73mm	16mm	84mm apart	42
25XAN	10A, removable extra switch, safety shutters & neons.	115mm	73mm	16mm	84mm apart	42
25XD	10A, double pole & removable extra switch.	115mm	73mm	16mm	84mm apart	42
STANDARD SIZE SINGLE SWITCHED SOCKET OUTLETS - 250V, VERTICALLY MOUNTED						
15V	10A.	115mm	73mm	14mm	84mm apart	43
15VS	10A with safety shutter.	115mm	73mm	14mm	84mm apart	43
15VN	10A with safety shutter and neon.	115mm	73mm	14mm	84mm apart	43
15V15	15A.	115mm	73mm	14mm	84mm apart	43
15V15N	15A with safety shutter and neon.	115mm	73mm	14mm	84mm apart	43
15VX	10A with removable extra switch.	115mm	73mm	14mm	84mm apart	43
15VXS	10A with safety shutters and removable extra switch.	115mm	73mm	14mm	84mm apart	43
15VXN	10A with safety shutters, neon and removable extra switch.	115mm	73mm	14mm	84mm apart	43
15VXX	10A with two removable extra switches.	115mm	73mm	14mm	84mm apart	43
STANDARD SIZE TWIN SWITCHED SOCKET OUTLETS - 250V/10A, VERTICALLY MOUNTED						
15/2V	Two piece base.	115mm	73mm	14mm	84mm apart	43
15/2VS	With safety shutters, two piece base.	115mm	73mm	14mm	84mm apart	43
15/2VN	With neons and safety shutters, two piece base.	115mm	73mm	14mm	84mm apart	43
15D2V	Double pole, two piece base.	115mm	73mm	14mm	84mm apart	43
15DD2V	Double pole with deep plate, two piece base.	133mm	83mm	37mm	97mm apart	43
25V	Twin Switched Socket Outlet, 250V/10A.	115mm	73mm	16mm	84mm apart	43
25VXA	With removable extra switch.	115mm	73mm	16mm	84mm apart	43
SKIRTING MOUNTED SINGLE SWITCHED SOCKET OUTLETS - 250V						
16	10A with safety shutter.	98mm	45mm	14mm	78mm apart	44
16N	10A with safety shutter and neon.	98mm	45mm	14mm	78mm apart	44
16F	10A, in line terminals.	98mm	45mm	14mm	78mm apart	44
16/15	15A.	98mm	45mm	14mm	78mm apart	44
16X	10A with extra switch.	125mm	45mm	14mm	104mm apart	44
16D	10A, double pole.	98mm	45mm	14mm	78mm apart	44
SKIRTING MOUNTED TWIN SWITCHED SOCKET OUTLETS - 250V						
16/2	10A.	168mm	45mm	13mm	145mm apart	44
16/2S	10A with safety shutters.	168mm	45mm	13mm	145mm apart	44
16/2N	10A with neons & safety shutters.	168mm	45mm	13mm	145mm apart	44
16/2F	10A with straight sides.	168mm	45mm	13mm	145mm apart	44
16/2MF	10A, suits ducting.	156mm	44mm	18mm	136mm apart	44
16/2MF1510	T15A & 10A, suits ducting.	156mm	44mm	18mm	136mm apart	44
16/2MFD	10A, double pole.	156mm	44mm	18mm	136mm apart	44
INTERMEDIATE SINGLE SWITCHED SOCKET OUTLETS - HORIZONTALLY MOUNTED						
14	Single Switched Socket Outlet, intermediate size, 250V/10A, horizontal.	115mm	61mm	13mm	84mm apart	44
LARGE FORMAT SIZE SINGLE SWITCHED SOCKET OUTLETS - 250V/10A, HORIZONTALLY MOUNTED						
15/2	Single pole.	115mm	115mm	14mm	84 x 46mm	45
15/2S	Single pole with safety shutter.	115mm	115mm	14mm	84 x 46mm	45
15/2N	Single pole with safety shutter & neon.	115mm	115mm	14mm	84 x 46mm	45
LARGE FORMAT SIZE TWIN SWITCHED SOCKET OUTLETS - 250V/10A, (115mm x 115mm), VERTICALLY MOUNTED						
25/2V	Twin Switched Socket Outlet.	115mm	115mm	11mm	84 x 46mm	45
25/2VS	With safety shutters.	115mm	115mm	11mm	84 x 46mm	45
25-2VN	With neons and safety shutters.	115mm	115mm	11mm	84 x 46mm	45
LARGE FORMAT SIZE TWIN SWITCHED SOCKET OUTLETS - HORIZONTALLY MOUNTED						
23	Twin Switched Socket Outlet, large format, 250V/10A.	145mm	86mm	15mm	120mm apart	45

STANDARD RANGE QUICK REFERENCE GUIDE (Continued)

PROTECTED SOCKET OUTLETS						
Cat No	Description	Length	Width	Depth	Mounting Centres	PAGE
15/15EL10	Single Switched Socket Outlet, 250V/15A, with RCD, 10mA.	116mm	74mm	30mm	84mm apart	46
15/15EL30	Single Switched Socket Outlet, 250V/15A, with RCD, 30mA.	116mm	74mm	30mm	84mm apart	46
25EL10	Twin Switched Socket Outlet, 250V/10A, with RCD, 10mA.	116mm	74mm	30mm	84mm apart	46
25EL30	Twin Switched Socket Outlet, 250V/10A, with RCD, 30mA.	116mm	74mm	30mm	84mm apart	46
25ELSB	Spacer Block, (L122 X W83 X H30mm).	116mm	74mm	30mm	84mm apart	46
25SF	Twin switched socket outlet, 250V/10A, surge protected. (L115 X W73 X H16mm).	115mm	73mm	plate - 17mm wall recess - 23mm	84mm apart	46
30SFFM	Surge Filter Mechanism, 250V/10A.	-	-	-	-	46
COOKER SOCKET OUTLET & PLUG						
800CL	1.8m, 4mm ² Cord, with 250V/32A 3 pin plug.	-	-	-	-	46
31VCS	3 Pin Cooker Socket on Standard Plate, 250V/32A (Suits 800CL).	115mm	73mm	11mm	84mm apart	46
UNIVERSAL SHAVER OUTLET - 240V-110V						
727	Universal Shaver Outlet, Dual Voltage.	258mm	73mm	17mm	230 x 40mm	46
727H	Universal Shaver Outlet, Dual Voltage (horizontal mount).	184mm	85mm	18mm	152mm	46
727V	Universal Shaver Outlet, Dual Voltage, (vertical mount).	184mm	85mm	18mm	152mm	46
TV ANTENNA CONNECTION ACCESSORIES						
31VTVA	1 Gang Standard Pattern Television Assembly.	115mm	73mm	11mm	84mm apart	47
31VTV75	TV Antenna Socket in Standard Plate, 75 Ohm.	115mm	73mm	11mm	84mm apart	47
31TVF	"PAY TV" Antenna Socket in Standard Plate.	115mm	73mm	11mm	84mm apart	47
32TVACFF	"PAY TV/FTA TV" with a.c. Isolation.	115mm	73mm	11mm	84mm apart	47
32TVFF	"PAY TV/FTA TV" with F Type Connection.	115mm	73mm	11mm	84mm apart	47
32TVSF	"PAY TV/FTA TV" Screw Coaxial Connection.	115mm	73mm	11mm	84mm apart	47
31VTV75ACF	TV Socket with 3kVAc Isolation, 75 Ohm in standard size plate.	115mm	73mm	11mm	84mm apart	47
31VTV75F	TV Socket with F Type Connection, 75 Ohm in standard size plate.	115mm	73mm	11mm	84mm apart	47
32VTV75FM	TV-FM Splitter in standard size plate.	115mm	73mm	11mm	84mm apart	47
TV CONNECTION SOCKETS, PLUGS & TERMINATORS						
30TV75P	Coaxial Cable Plug, 75 Ohm.	33mm	11mm	11mm	N/A	48
30TV75CS	TV Antenna Connection Socket, 75 Ohm.	33mm	11mm	11mm	N/A	48
30TV75C	Coaxial RG59 Cable Connection Plug, 75 Ohm screw type.	18mm	17mm	17mm	N/A	48
30TV75C1	Coaxial RG6 Cable Connection Plug, 75 Ohm screw type.	18mm	17mm	17mm	N/A	48
30TV75T	Terminator, suits sockets.	18mm	17mm	17mm	N/A	48
TV SURFACE MOUNTING CONNECTION ACCESSORY						
30TV75S	Coaxial Cable Surface Socket, 75 Ohm.	54mm	29mm	25mm	N/A	48
TV ANTENNA MECHANISMS						
30PFM	"F" Type Connection, 75 Ohm, suits "PAY TV".	22mm	22mm	26mm	N/A	49
30TVM	"PAY TV/FTA TV" with F Type Connection.	22mm	22mm	19mm	N/A	49
30TVFM	TV Socket, 300 Ohm type, front clip.	21mm	21mm	19mm	N/A	49
30TV75M	TV Antenna Socket, 75 Ohm, suits 30 Series plates.	22mm	22mm	38mm	N/A	49
30TV75MF	TV Antenna Socket, 75 Ohm, with "F" type connection.	22mm	22mm	35mm	N/A	49
30TV75MACF	TV Antenna Socket, 75 Ohm, with 3kV a.c. isolation.	22mm	22mm	33mm	N/A	49
30TV75MS	TV Antenna Socket, 75 Ohm (screw fixing, solderless).	22mm	22mm	28mm	N/A	49
TV FLY LEADS - 1.8M						
3105FL118MW	Male to Male.	N/A	N/A	N/A	N/A	49
3105FL118FW	Male to Female.	N/A	N/A	N/A	N/A	49
CHEMICAL RESISTANT STANDARD INDUSTRIAL RANGE						
31VA	Flush Plate, with 1 x 30M mechanism in vertical format.	115mm	73mm	11mm	84mm apart	51
32VA	Flush Plate, with 2 x 30M mechanism in vertical format.	115mm	73mm	11mm	84mm apart	51
33VA	Flush Plate, with 3 x 30M mechanism in vertical format.	115mm	73mm	11mm	84mm apart	51
34VA	Flush Plate, with 4 x 30M mechanism in vertical format.	115mm	73mm	11mm	84mm apart	51
35VA	Flush Plate, with 5 x 30M mechanism in vertical format.	115mm	73mm	11mm	84mm apart	51
36VA	Flush Plate, with 6 x 30M mechanism in vertical format.	115mm	73mm	11mm	84mm apart	51
31VX	Blank Flush Plate.	115mm	73mm	11mm	84mm apart	51
15	Single Switched Socket Outlet, 250V/10A, horizontal mounting.	115mm	73mm	14mm	84mm apart	51
15X	Single Switched Socket Outlet, 250V/10A, with extra switch, horizontal mounting.	115mm	73mm	14mm	84mm apart	51
15/15	Single Switched Socket Outlet, 250V/15A, horizontal mounting.	115mm	73mm	14mm	84mm apart	51
15V	Single Switched Socket Outlet, 250V/10A, vertical mounting.	115mm	73mm	14mm	84mm apart	51
25V	Twin Switched Socket Outlet, 250V/10A, single base, vertical mounting.	115mm	73mm	16mm	84mm apart	51
25	Twin Switched Socket Outlet, 250V/10A, horizontal mounting.	115mm	73mm	16mm	84mm apart	51
25XA	Twin Switched Socket Outlet, 250V/10A, with extra switch, horizontal mounting.	115mm	73mm	16mm	84mm apart	51
449A	1 Gang Mounting Block, suits all flush plates with 115 x 73mm and 84mm centres.	122mm	78mm	32mm	84mm apart	51
449ASD	14mm Spacer, for standard pattern accessories, with 84mm centres, four mounting holes in centre.	116mm	73mm	14mm	84mm apart	51

STANDARD RANGE QUICK REFERENCE GUIDE (Continued)

PROTECTED SWITCHED SOCKET OUTLETS - 250V/10A, ZINC DIE CAST						
Cat No	Description	Length	Width	Depth	Mounting Centres	PAGE
PC110	3 flat sockets.	100mm	79mm	50mm	82mm apart	54
PC110-2FR	2 flat, 1 round socket.	100mm	79mm	50mm	82mm apart	54
PC110-2RF	1 flat socket.	100mm	79mm	50mm	82mm apart	54
PC110-N	3 flat sockets, with neon.	100mm	79mm	50mm	82mm apart	54
PC110V-2	3 flat sockets, vertical mount, 2 gang.	142mm	102mm	50mm	84 x 82mm apart	54
PC110V-2-DP	zinc die cast, 3 flat sockets, vertical mount, 2 gang, double pole.	142mm	102mm	50mm	84 x 82mm apart	54
PROTECTED SWITCHED SOCKET OUTLETS - 250V/15A, ZINC DIE CAST						
PC115	3 flat sockets.	101mm	79mm	50mm	82mm apart	54
PC115-N	3 flat sockets, with neons.	101mm	79mm	50mm	82mm apart	54
PC115V-2	3 flat sockets, vertical mount, 2 gang.	141mm	102mm	50mm	84 x 82mm apart	54
SWITCH MECHANISMS - 250V UNLESS STATED OTHERWISE						
Cat No	Description					PAGE
30M	10A, 1 way/2 way - terminal bores of 4.1mm ϕ accommodate 4 x 1.5mm ² or 3 x 2.5mm ² cables. Body fits 22mm ϕ hole. M rating is 100.					56
30MRD	10A, 1 way/2 way (with red dolly mark) - terminal bores of 4.1mm ϕ accommodate 4 x 1.5mm ² or 3 x 2.5mm ² cables. Body fits 22mm ϕ hole. M rating is 100.					56
30FLM	10A, 1 way/2 way (suits fluoro loads) - terminal bores of 4.1mm ϕ accommodate 4 x 1.5mm ² or 3 x 2.5mm ² cables. Body fits 22mm ϕ hole. M rating is 120.					56
30FLM15	15A, 1 way/2 way (suits fluoro loads) - terminal bores of 4.1mm ϕ accommodate 4 x 1.5mm ² or 3 x 2.5mm ² cables. Body fits 22mm ϕ hole. M rating is 90.					56
30RSM2	15A, Rotary (2 On - 2 Off) - also suitable for 12V d.c. 15A, and audio and control applications. Switch positions indicated in window. M rating is 50.					56
30RSM3	15A, Rotary (3 On - 1 Off) - also suitable for 12V d.c. 15A, and audio and control applications. Switch positions indicated in window. M rating is 50.					56
30MCO	10A, Changeover, double throw (selects alternate circuits).					56
30MI	10A, Intermediate - four terminals of 3.5mm ϕ accommodates 2 x 2.5mm ² cables. Body fits 22mm ϕ hole.					56
30MBP	440V/15A, Bell press - offers facility for momentary ON or OFF (one Looping terminal).					56
30MBPN	15A, Illuminated bell press - offers facility for momentary ON or OFF. Neon is connected across terminals 1 & 4. Alternative lamp voltages available.					56
30MBPR	10A, Bell press rocker - offers facility for momentary ON or OFF. Suitable for extra low voltage applications (one Looping terminal).					56
30MD	10A, 1 way, double pole, single throw - terminal bores of 4.1mm ϕ accommodate 4 x 1.5mm ² or 3 x 2.5mm ² cables. Body fits 22mm ϕ hole. M rating is 90.					56
30HMD	10A, double pole, marked "HEAT".					56
30MD2	10A, 2 Way, double pole, double throw - six terminal bores of 4.1mm ϕ accommodate 4 x 1.5mm ² or 3 x 2.5mm ² cables. M rating is 75.					56
30MD15	15A, 1 way, double pole, single throw - terminal bores of 4.1mm ϕ accommodate 4 x 1.5mm ² or 3 x 2.5mm ² cables. Body fits 22mm ϕ hole. M rating is 90.					56
30MD20	20A, 1 way, double pole - 4 terminals of 1.5mm ϕ accommodate 3 x 2.5mm ² cables. Body fits 34mm ϕ hole. M rating is 100.					56
30M15	15A, 1 way/2 way - terminal bores of 4.1mm ϕ accommodate 4 x 1.5mm ² or 3 x 2.5mm ² cables. Body fits 22mm ϕ hole. M rating is 90.					56
30M15RD	15A, 1 way/2 way (with red dolly mark) - terminal bores of 4.1mm ϕ accommodate 4 x 1.5mm ² or 3 x 2.5mm ² cables. Body fits 22mm ϕ hole. M rating is 90.					56
30M20	20A, 1 way/2 way - terminal bores of 4.1mm ϕ accommodate 4 x 1.5mm ² or 3 x 2.5mm ² cables. Body fits 22mm ϕ hole. M rating is 90.					56
30M35	35A, 1 way/2 way - terminal bore of 3.6mm ϕ & Looping terminal bore of 3.9mm ϕ . M rating is 160. Marked 35A.					56
30TKM	20A (5A fluorescent load), 1 way/2 way, toggle key actuated - one Looping terminal. M rating is 100.					56
30/1/2LM	10A, 1 way (two Looping terminals) - terminal bores of 4.1mm ϕ accommodate 4 x 1.5mm ² or 3 x 2.5mm ² cables. Body fits 22mm ϕ hole. M rating is 100.					56
30/1ELM	10A, 1 way (one Looping & one Earth terminal) - terminal bores of 4.1mm ϕ accommodate 4 x 1.5mm ² or 3 x 2.5mm ² cables. Body fits 22mm ϕ hole. M rating is 100.					56
30/1NM	10A, 1 way rocker with neon indicator - neon can be wired to indicate ON, OFF or POWER AVAILABLE. Looping/switch terminal bores of 4.1mm ϕ . Body fits 34mm ϕ hole (Note: Neutral required).					56
30/2NM	10A, 2 way rocker with neon indicator - neon can be wired to indicate ON, OFF or POWER AVAILABLE. Looping/switch terminal bores of 4.1mm ϕ . Body fits 34mm ϕ hole (Note: Neutral not required).					56
30/5M	10A, 1 way/2 way (with 5 terminals - one Looping and one Earth terminal). Terminal bore of Common, Looping and Earth of 5.3mm ϕ accommodates 4 x 2.5mm ² cables. Terminal bore of '1' and '2' of 4.1mm ϕ accommodates 4 x 1.5mm ² or 3 x 2.5mm ² cables. Body fits 26mm ϕ hole. M rating is 40.					56
NEON INDICATOR MECHANISMS - 250V						
30N - RED	Neon indicator (RED)					57
30N - OTHER COLOURS	Neon indicator (OTHER COLOURS)					57
SWITCH MECHANISMS - 250V/10A, TERMINAL BORES OF 4.1mm ϕ ACCOMMODATE 4 X 1.5mm ² CABLES, BODY FITS 22mm ϕ HOLE 2 WAY WITH MESSAGES						
30FM	Marked "FAN" - M rating is 100.					57
30HM	Marked "HEAT" - M rating is 100.					57
30EM	Marked "EXHAUST" - M rating is 100.					57
30LM	Marked "LIGHT" - M rating is 100.					57
30MAM	Marked "MANUAL-AUTO" - M rating is 100.					57
30PM	Marked "DISPOSAL" - M rating is 100.					57
30XM	Marked "WASTE" - M rating is 100.					57
30YM	Marked "WASH" - M rating is 100.					57
30DNM	Marked "DAY/NIGHT" - M rating is 100.					57
30FAM	Marked "FAMILY" - M rating is 100.					57
30TM	Marked "T.V." - M rating is 100.					57
30COM	Marked "COOL" - M rating is 100.					57
30AUM	Marked "AUTO" - M rating is 100.					57
30ACM	Marked "AIR CON" - M rating is 100.					57
30STM	Marked "STUDY" - M rating is 100.					57

STANDARD RANGE QUICK REFERENCE GUIDE (Continued)

SWITCH MECHANISMS - 250V/10A, 2 WAY WITH MESSAGES		
250V/10A, TERMINAL BORES OF 4.1mm ø ACCOMODATE 4 X 1.5mm² OR 3 X 2.5mm² CABLES, BODY FITS 22mm ø HOLE 2 WAY WITH MESSAGES		
Cat No	Description	PAGE
30PUM	Marked "PUMP" - M rating is 100.	58
30BM	Marked "BATH" - M rating is 100.	58
30KM	Marked "KITCHEN" - M rating is 100.	58
30RUM	Marked "RUMPUS" - M rating is 100.	58
30LOM	Marked "LOUNGE" - M rating is 100.	58
30DM	Marked "DINE" - M rating is 100.	58
30FNM	Marked "OFF/ON" - M rating is 100.	58
30AM	Marked "ALARM" - M rating is 100.	58
30BDM	Marked "BED" - M rating is 100.	58
30BD1M	Marked "BED1" - M rating is 100.	58
30BD2M	Marked "BED2" - M rating is 100.	58
30BD3M	Marked "BED3" - M rating is 100.	58
30BD4M	Marked "BED4" - M rating is 100.	58
30HLM	Marked "HI/LOW" - M rating is 100.	58
30MSEN	Marked "SENSOR" - M rating is 100.	58
30MOS	Marked "OUTSIDE" - M rating is 100.	58
30MFR	Marked "FORWARD/REVERSE" - M rating is 100.	58
30MFD	Marked "FRIDGE" - M rating is 100.	58
30MMW	Marked "MICROWAVE" - M rating is 100.	58
30MZ1	marked "ZONE1" - M rating is 100.	58
30MZ2	Marked "ZONE2" - M rating is 100.	59
30MZ3	Marked "ZONE3" - terminal bores of 4.1mm ø accommodate 4 x 1.5mm ² or 3 x 2.5mm ² cables. Body fits 22mm ø hole. M rating is 100.	59
30MZ4	Marked "ZONE4" - terminal bores of 4.1mm ø accommodate 4 x 1.5mm ² or 3 x 2.5mm ² cables. Body fits 22mm ø hole. M rating is 100.	59
39M	3 Position - marked "HI-OFF-LO". Three terminals, 3.5mm ø accommodate 2 x 2.5mm ² cables.	59
39MAOM	3 Position - marked "MAN-OFF-AUTO". Three terminals, 3.5mm ø accommodate 2 x 2.5mm ² cables.	59
39MSON	3 Position - marked "SENSOR-OFF-ON". Three terminals, 3.5mm ø accommodate 2 x 2.5mm ² cables.	59
SWITCH MECHANISMS - 250V/16A, TERMINAL BORES OF 4.1mm ø ACCOMODATE 4 X 1.5mm² OR 3 X 2.5mm² CABLES, BODY FITS 22mm ø HOLE 2 WAY WITH MESSAGES		
30M16SEN	Marked "SENSOR" - M rating is 100.	59
30M16OS	Marked "OUTSIDE" - M rating is 100.	59
30M16FR	Marked "FORWARD/REVERSE" - M rating is 100.	59
30M16FD	Marked "FRIDGE" - M rating is 100.	59
30M16MW	Marked "MICROWAVE" - M rating is 100.	59
SWITCH MECHANISM - 250V/20A, 2 WAY WITH MESSAGE		
30M20HW	Marked "HOT WATER SERVICE" - terminal bores of 4.1mm ø accommodate 4 x 1.5mm ² or 3 x 2.5mm ² cables. Body fits 22mm ø hole. M rating is 100.	59
SWITCH MECHANISMS - 250V/35A, TERMINAL BORES OF 4.1mm ø ACCOMODATE 4 X 1.5mm² OR 3 X 2.5mm² CABLES, BODY FITS 22mm ø HOLE 2 WAY WITH MESSAGES		
30M35HOB	Marked "HOB" - terminal bores of 4.1mm ø accommodate 4 x 1.5mm ² or 3 x 2.5mm ² cables. Body fits 22mm ø hole. M rating is 100.	59
30M35OV	Marked "OVEN" - terminal bores of 4.1mm ø accommodate 4 x 1.5mm ² or 3 x 2.5mm ² cables. Body fits 22mm ø hole. M rating is 100.	59
30M35R	Marked "RANGE" - terminal bores of 4.1mm ø accommodate 4 x 1.5mm ² or 3 x 2.5mm ² cables. Body fits 22mm ø hole. M rating is 100.	59
10A ILLUMINATED ROCKER SWITCH MECHANISMS, 250V/10A, 2 WAY INBUILT NEON, WITH MESSAGES		
30/2NMTSEN	Marked "SENSOR". Neon can be wired to indicate ON, OFF or POWER AVAILABLE. Looping/switch terminals of bore 3.9mm ø. Body fits 34mm ø hole.	60
30/2NMOS	Marked "OUTSIDE". Neon can be wired to indicate ON, OFF or POWER AVAILABLE. Looping/switch terminals of bore 3.9mm ø. Body fits 34mm ø hole.	60
DIMMER, FAN CONTROL AND SURGE FILTER MECHANISMS		
32E450LM	CThru® Dimmer Mechanism, Leading Edge (suits incandescent lighting and low voltage lighting using iron core transformers), 220 - 240V/450W.	60
32E450TM	CThru® Dimmer Mechanism, Trailing Edge (suits incandescent lighting and low voltage lighting using electronic transformers), 220 - 240V/450W.	60
32E500FM	CThru® Fan Speed Controller Mechanism, 220-240V/500W.	60
30POTDM	Dimmer Potentiometer (suits products such as 780 Series and the 761 Series).	60
30POTFM	Fan Controller Potentiometer (suits products such as 32 Series High Powered Dimmers & 761 Series).	60
30SFM	Surge Filter Mechanism - 250V 10A.	60
CIRCUIT IDENTIFICATION AND BLANKING PRODUCTS		
30P	Removable Blank Plug, to suit or blank out 30 Series aperture.	60
30PID	Removable Plug, with identification facility, supplied with tamper proof transparent cover.	60
30PFO	Plug, marked "FRIDGE - FREEZER ONLY".	60
30PIDA4L	Label Sheets, 10 x A4 packet, red and white available (non-adhesive).	60

	Cat No.	10, 10D, 10DS, 10DN, 10DLS, 10DLSS, 20, 20D, 20DS, 20DN, 15, 15S, 15N, 15D, 15D15, 15DN, 15/15, 15/15S, 15/15N, 15L, 15LN, 15X, 15XX, 25, 25L, 25X, 25XS, 25XA, 25XAN, 25XD, 25S, 25N, 25D, 25D15, 25/15, 25/15S, 25/15N, 25/15D, 42/20, 42/20N	15DD	15DX	15V, 15VX, 15VXX, 15V15, 25V, 25VXA	15/2V, 15/2VS, 15/2VN, 15D2V	15/2, 15/2S, 15/2N, 25/2V, 25/2VS, 25/2VN	15DD2V	40	14	16, 16N, 16F, 16/15	16/2, 16/2S, 16/2N, 16/2F	16X	23, 23X
FIRE RATED WALL BOXES	157/1F	YES	YES	YES	YES	YES	NS	NS3	NS3	YES	NS13	NS14	NS15	NS16
	F157/1	YES	YES	YES	YES	YES	NS	NS3	NS3	YES	NS13	NS14	NS15	NS16
	157/2F	NS12	NS12	NS12	NS12	NS12	YES	NS3	NS3	NS12	NS13	NS14	NS15	NS16
ENCLOSURES	224/1	YES	NS12	YES	AS	AS	NS	NS3	NS3	NS12	NS13	NS14	NS15	NS16
	223H	Y1	NS12	NS	AS	AS	NS	NS3	NS3	NS12	NS13	NS14	NS15	NS16
	255	YES	NS12	YES	AS	AS	NS	NS3	NS3	NS12	NS13	NS14	NS15	NS16
JUNCTION BOXES	240 Series	NS12	NS12	NS12	NS12	NS12	NS	NS3	NS3	NS12	NS13	NS14	NS15	NS16
	T240 Series	NS12	NS12	NS12	NS12	NS12	NS	NS3	NS3	NS12	NS13	NS14	NS15	NS16
	SC240 Series	NS12	NS12	NS12	NS12	NS12	NS	NS3	NS3	NS12	NS13	NS14	NS15	NS16



YOU WILL FIND THE KEY TO THIS TABLE ON PAGE 86

MOUNTING ACCESSORIES CROSS REFERENCE CHART

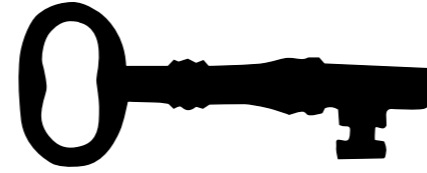

CODE	DESCRIPTION - NOT SUITABLE
AS	The product can be mounted, however, it will not meet Australian Standards requirements.
N3	Product base fouls the accessory mounting bosses, meaning that the product can't be mounted flush.
N6	The product can be mounted, however, the 'press to test' & 'press to reset' buttons can't be pushed.
N8	The finished result looks very unprofessional.
N10	Mounting centres line up, however, the product overhangs the accessory.
N12	The bosses attaching the mechanism back box to the flush plate protrude below the flush plate edge, meaning that the product can't be mounted flush.
N13	Product base is too large to fit into the accessory.
NS1	Can be direct mounted to surface (55mm mounting centres).
NS2	Can be direct mounted to surface (70mm mounting centres).
NS3	Can be direct mounted to surface (98mm mounting centres).
NS4	Can be direct mounted to surface (124mm mounting centres).
NS5	Can be direct mounted to surface (40mm mounting centres).
NS6	Can be direct mounted to surface (60mm mounting centres).
NS7	Can be direct mounted to surface (87mm mounting centres).
NS8	Can be direct mounted to surface (78mm mounting centres).
NS9	Can be direct mounted to surface (136mm mounting centres).
NS10	Can be direct mounted to surface (84mm mounting centres - 3 sets, 46mm apart).
NS11	Can be direct mounted to surface (50mm mounting centres).
NS12	Can be direct mounted to surface (84mm mounting centres).
NS13	Can be direct mounted to surface (75mm mounting centres).
NS14	Can be direct mounted to surface (145mm mounting centres).
NS15	Can be direct mounted to surface (104mm mounting centres).
NS16	Can be direct mounted to surface (120mm mounting centres).
NS17	Can be direct mounted to surface (230mm x 40mm mounting centres).
NS18	Can be direct mounted to surface (153mm mounting centres).
T	The text on the top of the cover can't be seen.
CODE	DESCRIPTION - SUITABLE
X5	Ensure mounting accessory is set back 25mm from outer wall surface.
Y1	Allow 10mm depth for mechanism and cable protrusion.
Y2	Allow 15mm depth for mechanism and cable protrusion.
Y3	Allow 20mm depth for mechanism and cable protrusion.
Y4	Allow 25mm depth for mechanism and cable protrusion.
Y6	Allow 45mm depth for mechanism and cable protrusion.
Y7	The conduit plugs or conduit have to be shortened to accommodate the large base of product.

MOUNTING ACCESSORIES CROSS REFERENCE CHART

It is often difficult to determine which mounting accessory is best utilised when installing the vast amount of products in the Clipsal switch & socket ranges. The cross-reference chart in the following pages will help you to simplify this task.

Individual Switch & Socket sections for the Standard Range have been formatted to indicate if a product can or cannot be installed with a particular mounting accessory.

This cross reference charts is best used in conjunction with the "Key" on Page 86.

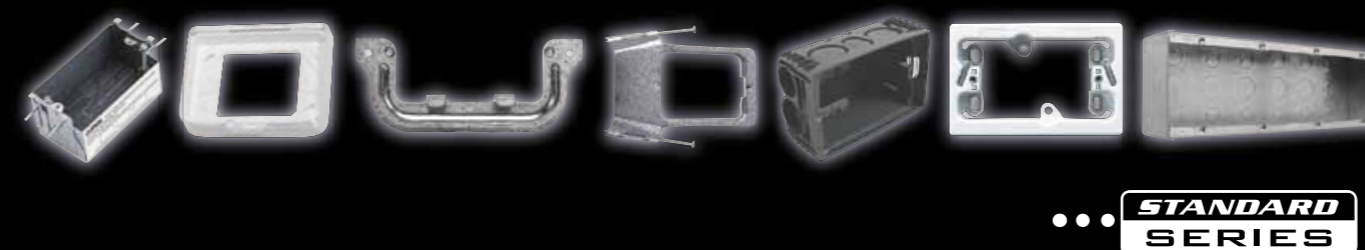

Product of Clipsal Australia Pty Ltd
ABN 27 007 873 529

Head Office
12 Park Terrace, Bowden
South Australia 5007
Telephone (08) 8269 0511
Facsimile (08) 8340 1724
Internet clipsal.com
E-Mail plugin@clipsal.com.au

Offices in all States

NSW Sydney (02) 9794 9200
Albury (02) 6041 2377

VIC Melbourne (03) 9207 3200
Country Areas 1800 653 893

QLD Brisbane (07) 3244 7444
Townsville (07) 4729 3333

SA Adelaide (08) 8268 0400

WA Perth (08) 9442 4444

TAS Launceston (03) 6343 5900

NT Darwin (08) 8947 0278

Area Representatives

NSW Albury (02) 6041 2377
Mid North Coast 0418 430 361
Coffs Harbour 0418 653 183
Dubbo 0418 822 564
Newcastle 0407 298 792
0418 434 169
0418 686 040

South West Sydney 0419 868 353
Tamworth 0417 714 339
Wagga Wagga 0418 578 903
Wollongong 0418 423 581

International Enquiries

International Sales and Marketing
Telephone + 61 8 8269 0587
Facsimile + 61 8 8340 7350
E-Mail export@clipsal.com.au

New Zealand
Clipsal Industries (NZ) Ltd
Telephone (09) 576 3403
Facsimile (09) 576 1015
E-Mail headoffice@clipsal.co.nz

Customer Service
Free Fax (0508) 250 305
Auckland/Mobile Phone (09) 572 0014
Free Phone (0508) CLIPSAL 2547725

ACT Canberra 0419 238 824
0418 164 070

VIC Bendigo 0418 570 213
Geelong 0418 527 233
Gippsland 0418 512 680
Western Victoria 0419 380 444

QLD Cairns 0418 773 254
Mackay 0418 752 134
Maryborough 0418 664 338
Northern Rivers 0419 869 752
Rockhampton 0418 711 786
Sunshine Coast 0418 726 394
Toowoomba 0418 180 372
Townsville

WA Bunbury 0418 931 684
Kalgoorlie & Eastern Gold Fields 0417 928 981
Karratha 0418 937 249

SA Riverland/Mildura/
Broken Hill 0418 596 145

clipsal.com

Special thanks to Graham Ward (Active Connection Electrical) and Greg Spurling (Spurling Electrical) for their contribution to this catalogue.

The shape of the switch dolly is a trade mark of Clipsal Australia Pty. Ltd.

Clipsal Australia Pty Ltd reserves the right to change specifications, modify designs and discontinue items without incurring obligation and whilst every effort is made to ensure that descriptions, specifications and other information in this catalogue are correct, no warranty is given in respect thereof and the company shall not be liable for any error therein.

©Copyright Clipsal Australia Pty Ltd 2005. All rights reserved.
This material is copyright under Australian and international laws. Except as permitted under the relevant law, no part of this work may be reproduced by any process without prior written permission of and acknowledgement to Clipsal Australia Pty Ltd.