

ZB5AD5

black selector switch head Ø22 3-position
spring return



Main

| | |
|-------------------------------|-----------------------------|
| Commercial Status | Commercialised |
| Range of product | Harmony XALF Harmony XB5 |
| Product or component type | Head for selector switch |
| Device short name | ZB5 |
| Bezel material | Plastic |
| Mounting diameter | 22 mm |
| Sale per indivisible quantity | 1 |
| Shape of signaling unit head | Round |
| Type of operator | Spring return to centre |
| Operator profile | Black standard handle |
| Operator position information | 3 positions +/- 45° |

Complementary

| | |
|-----------------------------|--|
| CAD overall width | 29 mm |
| CAD overall height | 29 mm |
| CAD overall depth | 44 mm |
| Product weight | 0.017 kg |
| Mechanical durability | 1000000 cycles |
| Maximum of contact NO or NC | 4 |
| Station name | XALK 2...5 cut-outs XALD 1...5 cut-outs |

Environment

| | |
|--|---|
| Protective treatment | TH |
| Ambient air temperature for storage | -40...70 °C |
| Ambient air temperature for operation | -25...70 °C |
| Class of protection against electric shock | Class II conforming to IEC 60536 |
| IP degree of protection | IP69 K conforming to IEC 60529 |
| NEMA degree of protection | NEMA 4X NEMA 13 |
| Resistance to high pressure washer | 7000000 Pa at 55 °C, distance: 0.1 m |
| IK degree of protection | IK06 conforming to IEC 50102 |
| Standards | CSA C22-2 No 14 EN/IEC 60947-1 EN/IEC 60947-5-1 EN/IEC 60947-5-4 EN/IEC 60947-5-5 JIS C 4520 UL 508 |
| Product certifications | BV CSA DNV GL LROS (Lloyds register of shipping) RINA UL listed |

The information provided in this documentation contains general descriptions and/or technical characteristics of the performance of the products contained herein. This documentation is not intended as a substitute for and is not to be used for determining suitability or reliability of these products for specific user applications. It is the duty of any such user or integrator to perform the appropriate and complete risk analysis, evaluation and testing of the products with respect to the relevant specific application or use thereof. Neither Schneider Electric Industries SAS nor any of its affiliates or subsidiaries shall be responsible or liable for misuse of the information contained herein.

| | |
|----------------------|--|
| Vibration resistance | 5 gn (f = 2...500 Hz) conforming to IEC 60068-2-6 |
| Shock resistance | 50 gn for 11 ms half sine wave acceleration conforming to IEC 60068-2-27 30 gn for 18 ms half sine wave acceleration conforming to IEC 60068-2-27 |

Dimensions of Heads for Selector Switches

Standard Handle Operator

ZB5 AD•, ZB5 AD•M

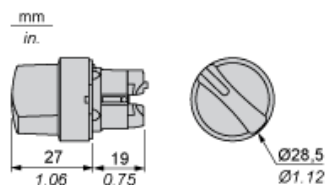

Long Handle Operator

ZB5 AJ•, ZB5 AJ•M

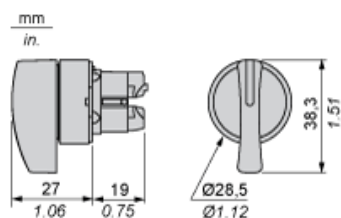

Black Knurled Knob

ZB5 AD•9

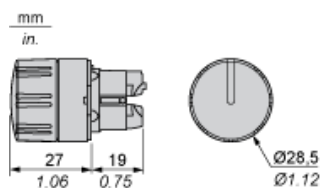

Key Switch (Ronis n° 455)

ZB5 AG•, ZB5 AG0•, ZB5 AG•M

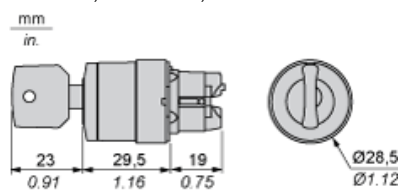

Key Switch (DOM n° 8D1)

ZB5 AGD

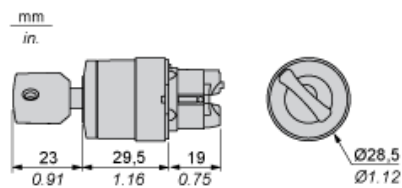

Panel Cut-out for Pushbuttons, Switches and Pilot Lights (Finished Holes, Ready for Installation)

Connection by Screw Clamp Terminals or Plug-in Connectors or on Printed Circuit Board



- (1) Diameter on finished panel or support
- (2) For selector switches and Emergency stop buttons, use of an anti-rotation plate type ZB5 AZ902 is recommended.
- (3) $\varnothing 22.5$ mm recommended ($\varnothing 22.3 \text{ }_0^{+0.4}$) / $\varnothing 0.89$ in. recommended ($\varnothing 0.88 \text{ in. }_0^{+0.016}$)

| Connections | a in mm | a in in. | b in mm | b in in. |
|---|---------|----------|---------|----------|
| By screw clamp terminals or plug-in connector | 40 | 1.57 | 30 | 1.18 |
| By Faston connectors | 45 | 1.77 | 32 | 1.26 |
| On printed circuit board | 30 | 1.18 | 30 | 1.18 |

Detail of Lug Recess

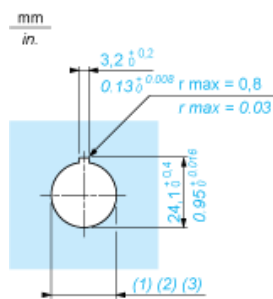

- (1) Diameter on finished panel or support
- (2) For selector switches and Emergency stop buttons, use of an anti-rotation plate type ZB5 AZ902 is recommended.
- (3) $\varnothing 22.5$ mm recommended ($\varnothing 22.3 \text{ }_0^{+0.4}$) / $\varnothing 0.89$ in. recommended ($\varnothing 0.88 \text{ in. }_0^{+0.016}$)

Pushbuttons, Switches and Pilot Lights for Printed Circuit Board Connection

Panel Cut-outs (Viewed from Installer's Side)



- A: 30 mm min. / 1.18 in. min.
- B: 40 mm min. / 1.57 in. min.

Printed Circuit Board Cut-outs (Viewed from Electrical Block Side)

Dimensions in mm

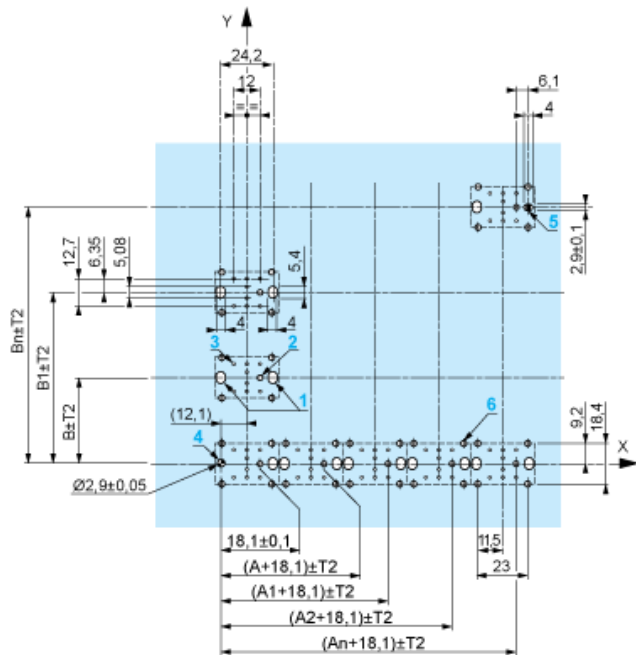

- A: 30 mm min.
- B: 40 mm min.

Dimensions in in.

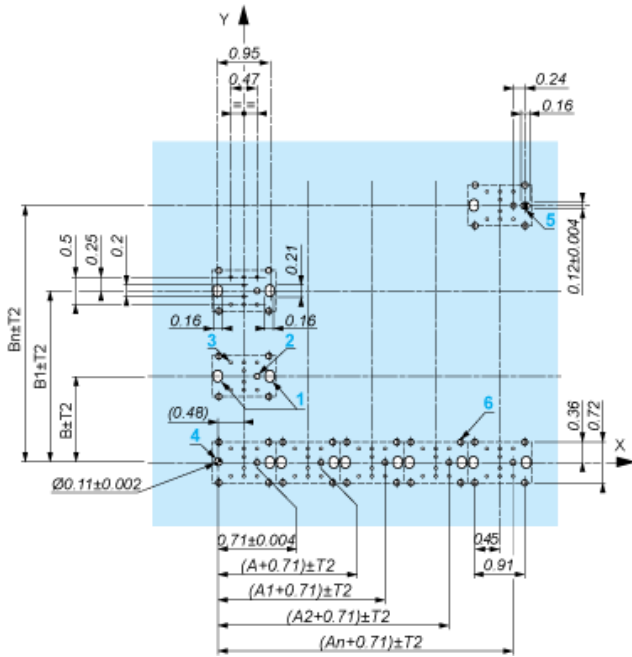

- A: 1.18 in. min.
- B: 1.57 in. min.

General Tolerances of the Panel and Printed Circuit Board

The cumulative tolerance must not exceed 0.3 mm / 0.012 in.: $T1 + T2 = 0.3 \text{ mm max.}$

Installation Precautions

- Minimum thickness of circuit board: 1.6 mm / 0.06 in.
- Cut-out diameter: 22.4 mm \pm 0.1 / 0.88 in. \pm 0.004
- Orientation of body/fixing collar ZB4 BZ009: $\pm 2^\circ 30'$ (excluding cut-outs marked a and b).
- Tightening torque of screws ZBZ 006: 0.6 N.m (5.3 lbf.in) max.
- Allow for one ZB4 BZ079 fixing collar/pillar and its fixing screws:
 - every 90 mm / 3.54 in. horizontally (X), and 120 mm / 4.72 in. vertically (Y).
 - with each selector switch head (ZB5 AD•, ZB5 AJ•, ZB5 AG•).

The fixing centers marked a and b are diagonally opposed and must align with those marked 4 and 5.

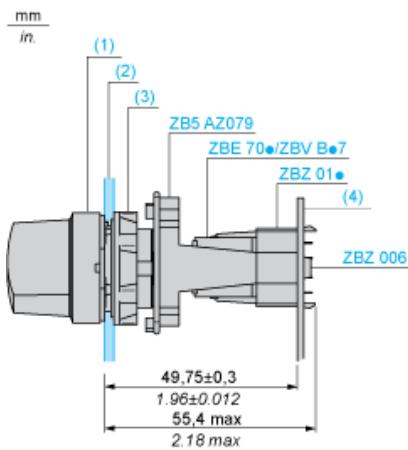

- (1) Head ZB5 AD•
- (2) Panel
- (2) Nut
- (4) Printed circuit board

Mounting of Adapter (Socket) ZBZ 01•

- 12 elongated holes for ZBZ 006 screw access
- 2 1 hole $\varnothing 2.4 \text{ mm} \pm 0.05 / 0.09 \text{ in.} \pm 0.002$ for centring adapter ZBZ 01•
- 3 $8 \times \varnothing 1.2 \text{ mm} / 0.05 \text{ in.}$ holes
- 4 1 hole $\varnothing 2.9 \text{ mm} \pm 0.05 / 0.11 \text{ in.} \pm 0.002$, for aligning the printed circuit board (with cut-out marked a)
- 5 1 elongated hole for aligning the printed circuit board (with cut-out marked b)
- 6 4 holes $\varnothing 2.4 \text{ mm} / 0.09 \text{ in.}$ for clipping in adapter ZBZ 01•

Dimensions An + 18.1 relate to the $\varnothing 2.4 \text{ mm} \pm 0.05 / 0.09 \text{ in.} \pm 0.002$ holes for centring adapter ZBZ 01•.