

# Pistol grip XAC-A

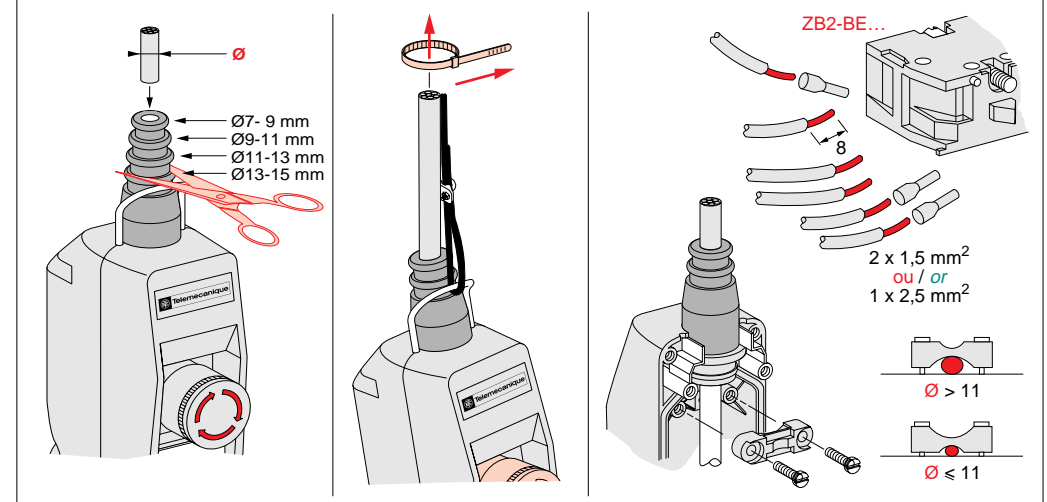

## 1 VITESSE XAC-A2●1●

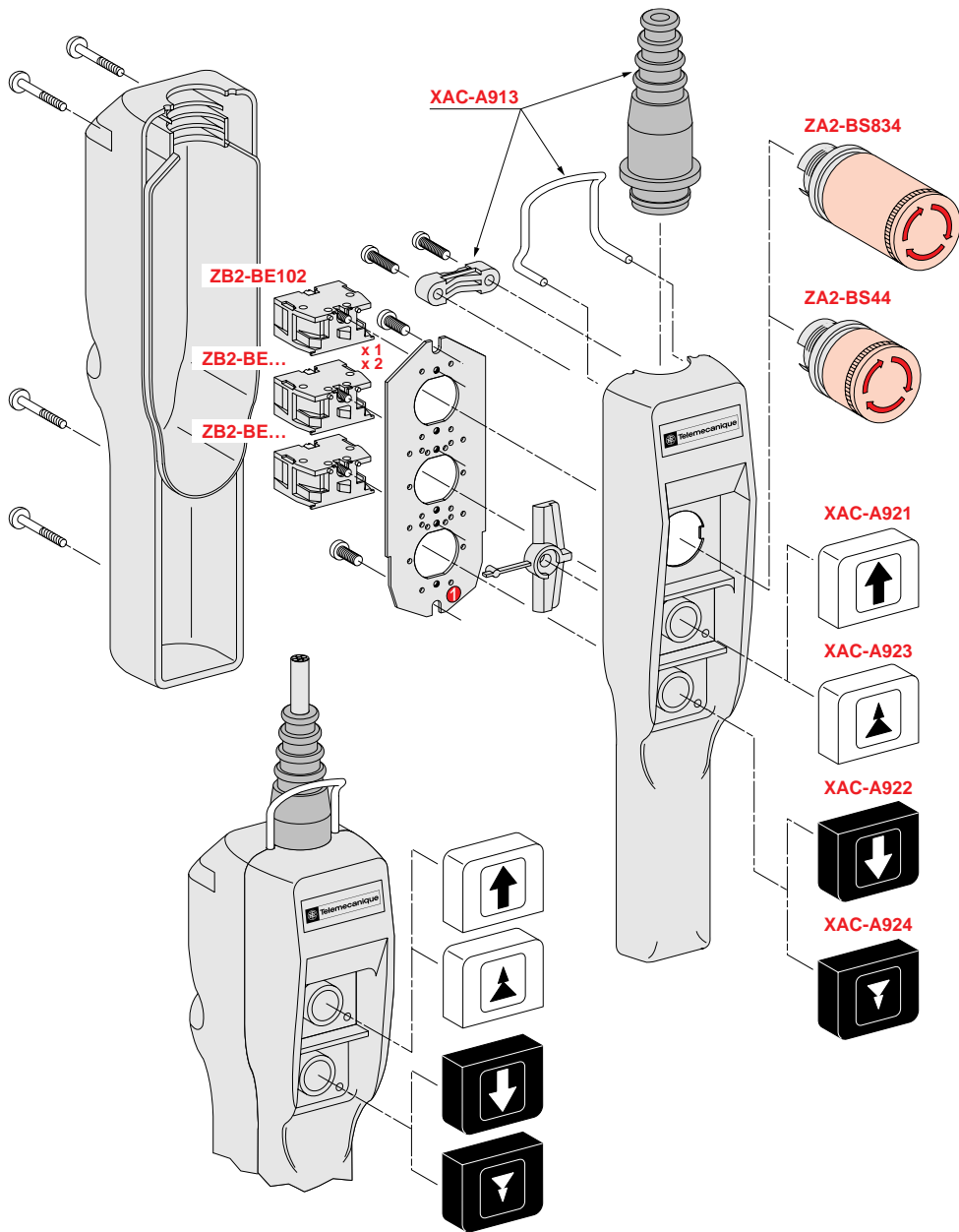
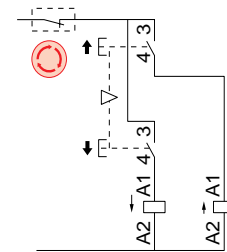

## XAC-A2●5●

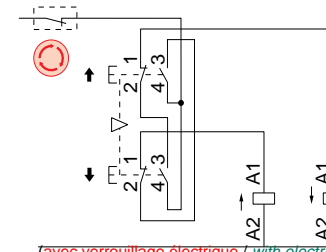

## 2 VITESSES XAC-A2●7●

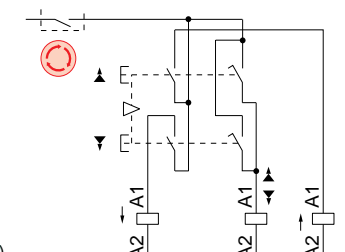

(avec verrouillage électrique / with electrical locked)

## Caractéristiques des éléments de contact / Contact block characteristics

<b>Caractéristiques assignées d'emploi / Rated operational characteristics</b>		~ AC-15 : A 600 ou/ou Ue = 600 V, ie = 1,2 A ou/ou Ue = 240 V, ie = 3 A = DC-13 : Q 600 ou/ou Ue = 600 V, ie = 0,1 A ou/ou Ue = 250 V, ie = 0,27 A
<b>Courant thermique / Thermal current (Ithe) A</b>		10
<b>Tension assignée d'isolement / Rated insulation voltage (Ui) V</b>		600, degré de pollution 3 selon IEC 947-1 / 600, degree of pollution 3 conforming to IEC 947-1
<b>Tension assignée de tenue aux chocs / Rated impulse withstand voltage (U imp) kV</b>		6 selon IEC 947-1 / 6 conforming to IEC 947-1
<b>Positivité / Positive operation</b>		Bouton "coup de poing" : contact à manœuvre positive d'ouverture selon IEC 947-5-1 chapitre 3 / Mushroom head pushbutton : contact with positive opening operation conforming to IEC 947-5-1
<b>Mode de fonctionnement des contacts / Contact operation</b>		A action dépendante / Slow break
<b>Résistance entre bornes / Resistance across terminals</b>		mΩ ≤ 25
<b>Force d'actionnement / Operating force</b>		N XAC-A2●● : 13 à/à 15
<b>Marquage des bornes / Terminal referencing</b>		Par chiffres selon / By numbers conforming to CENELEC EN 50013
<b>Protection contre les courts-circuits / Short-circuit protection</b>		Cartouche fusible 10 A type gG (gl) / 10 A cartridge fuse type gG (gl)
<b>Raccordement / Cabling</b>		Sur bornes à vis-étriers imperdables. Capacité de serrage : 1x2,5 ou 2x1,5 avec ou sans embout / Screw and captive cable clamp terminals. Capacity : 1 x 2.5 or 2 x 1.5 with or without cable end

# Pistol grip XAC-A

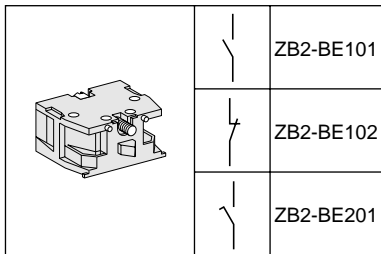

XAC-A201	XAC-A203	XAC-A205	XAC-A211	XAC-A213	XAC-A215	XAC-A207	XAC-A217	XAC-A2013 XAC-A2014	XAC-A2033 XAC-A2034	XAC-A2053 XAC-A2054	XAC-A2113 XAC-A2114	XAC-A2133 XAC-A2134	XAC-A2153 XAC-A2154	XAC-A2073 XAC-A2074	XAC-A2173 XAC-A2174		

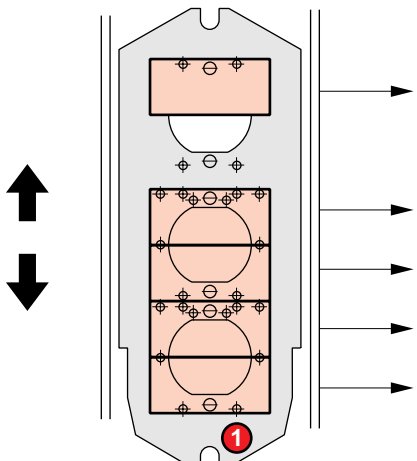

Retourner la platine /  
Return the platine

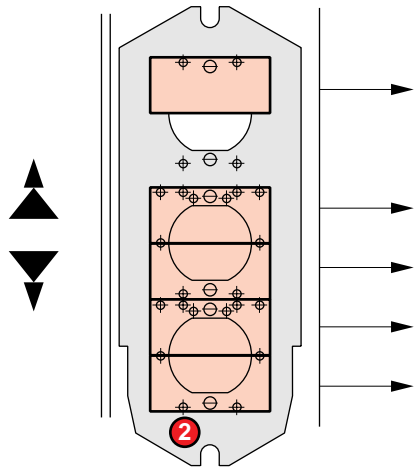

								ZB2-BE102	ZB2-BE102	ZB2-BE102	ZB2-BE102	ZB2-BE102	ZB2-BE102				
ZB2-BE101	ZB2-BE101	ZB2-BE101	ZB2-BE101	ZB2-BE101	ZB2-BE101			ZB2-BE101	ZB2-BE101	ZB2-BE101	ZB2-BE101	ZB2-BE101	ZB2-BE101				
	ZB2-BE101	ZB2-BE102		ZB2-BE101	ZB2-BE102			ZB2-BE101	ZB2-BE102		ZB2-BE101	ZB2-BE102					
ZB2-BE101	ZB2-BE101	ZB2-BE101	ZB2-BE101	ZB2-BE101	ZB2-BE101			ZB2-BE101	ZB2-BE101	ZB2-BE101	ZB2-BE101	ZB2-BE101	ZB2-BE101				
	ZB2-BE101	ZB2-BE102		ZB2-BE101	ZB2-BE102			ZB2-BE101	ZB2-BE102		ZB2-BE101	ZB2-BE102					

															ZB2-BE102	ZB2-BE102	
						ZB2-BE101	ZB2-BE101								ZB2-BE101	ZB2-BE101	
						ZB2-BE201	ZB2-BE201								ZB2-BE201	ZB2-BE201	
						ZB2-BE101	ZB2-BE101								ZB2-BE101	ZB2-BE101	
						ZB2-BE201	ZB2-BE201								ZB2-BE201	ZB2-BE201	