

NON metallic

cable enclosures & fittings

Complete Cover For Your Cables

technical data

NON metallic

cable enclosures & fittings



page

CONTENTS

2	Introduction
4	General Specifications
5	Rigid Non Metallic Conduit
6	Corflo Heavy Duty Conduit
7	Telecommunications and Security Conduit
8	Jointing Cement
9	Cutters and Bending Springs
10	Non Metallic Conduit Fittings
23	Elbows and Bends
27	Junction Boxes 16 to 25mm
32	Junction Boxes 32 to 50mm
33	Junction Boxes 63mm
34	Accessories for Round Junction Boxes
37	Fixing Accessories
41	265 Series Adaptable Boxes
43	Flexible Conduit Terminators
44	Telecommunications Fittings
47	Security Fittings
49	Non Metallic Corrugated Conduit
51	Glands for Corrugated Conduit
53	Duct and Fittings Range
55	Duct Fittings
62	Mounting Accessories
64	Polymeric Cable Cover



NON METALLIC CABLE EN

NON metallic cable enclosures & fittings

Clipsal pioneered the use of adjustable conduit fittings back in 1920 when Alfred Gerard developed a range of fittings manufactured from sheet metal which could be expanded or contracted.

At that time all electrical conduit used in Australia was imported from overseas, and made to various standards and unacceptable size variations.

This meant that for years Australia's electrical contractors experienced difficulties in joining lengths of conduit in situations where the diameter of the fittings, which were also imported, was different to those of the conduit itself.

With Alfred Gerard's cleverly designed conduit fittings that 'clipped all' sizes of imported conduit, it was natural that he should call his new brand Clipsal.

Since those early days, Clipsal has continued to lead the conduit and conduit fittings' market with innovative products that are at the forefront of design and reliability to completely meet the needs of the electrical industry.



ENCLOSURES AND FITTINGS



While we continue to manufacture a wide range of metal conduit fittings, the use of plastics means that we can offer even greater flexibility with our non metallic conduit and fittings.

Today, our range of conduit fittings is one of the most comprehensive available and includes everything to make your job easier, including conduit boxes, tangential boxes, bends, elbows, adaptors, saddles, large bends and underground bends, to name just a few.

From everyday installations to 'one off' jobs, Clipsal conduit and conduit fittings have you covered.

Note: Also available are non metallic HFT rigid and corrugated conduit, and flexible electrical hose. For details on these products, please refer to the Clipsal Halogen Free Conduit and Hose Technical Data Catalogue.

15 YEAR PRODUCT WARRANTY

To protect the customer's best interests, Clipsal has extended its product warranty to a full 15 years.



NON METALLIC CONDUIT AND FITTINGS

Manufacturing Specifications

All Clipsal Rigid Non Metallic Conduit and Fittings are manufactured in strict accordance with relevant sections of AS/NZS 2053 Conduit and Fittings for Electrical Installations.

Operative temperature range -15°C to +65°C.

Most Clipsal Conduit Fittings are suitable for use underground and are marked HD (Heavy Duty).

Note: Screw threads of nominal sizes of conduit 16 to 63mm are metric conduit threads with a 1.5mm pitch, complying with AS 1721.

Sizes 80 to 150 are BSP threads complying with AS 1722.

Unless specified otherwise all dimensions are nominal.

Chemical Resistance

Resistance to most common corroding agents, including the majority of oils and fats, inorganic acids, alkalis and salts, is a feature of Clipsal Rigid Non Metallic Conduit and Fittings. However, they are not recommended for use with Ketones, Esters or Aromatic or Chlorinated Hydrocarbons.

Effects of Temperature

Rigid Non Metallic Conduit has a relatively high co-efficient of expansion (approximately 0.1 metre per 100 metres per 10°C). In long runs likely to be subjected to wide temperature variations, expansion couplings should be provided in each standard length.

Installation

When installing rigid Non Metallic Conduit, support saddles or clips should be located at intervals of not more than one metre.

For more information regarding these points see relevant sections of AS/NZS 3000.

It is not recommended to use Rigid Non Metallic Conduit and Fittings where they are likely to be subjected to severe mechanical abuse without providing additional protection.

Bending Conduit

Circular conduit not exceeding 25mm in diameter can be bent 'cold' using the appropriate Clipsal Bending Spring (Cat. No. 266 Series). Please refer to page 9.

Where heat is required on small conduit, the area to be bent may be heated by brisk rubbing. On larger conduit, heat can be supplied by careful application of an L.P.G. gas flame.

When bending Non Metallic conduit, a minimum radius six times the conduit diameter is recommended.

To maintain a good bend and to reduce 'creep', it is necessary to over bend, then allow the tube to ease to the desired position.

Fix conduit with saddles, or other supports, as soon as possible after bending.

Bending Recommendations

Conduit Outside Diameter	Minimum Radius
16mm	96mm
20mm	120mm
25mm	150mm
32mm	200mm
40mm	240mm
50mm	300mm
63mm	380mm

Jointing - Recommended Method

The following is a simple, quick method using Clipsal Jointing Cement.

- 1 Cut conduit to length and remove all burrs.
- 2 Remove any dirt or grease with a clean cloth dipped in methylated spirits.
- 3 Coat both surfaces to be joined and within one minute push together. Give a quarter turn to spread cement evenly and wipe off excess immediately.
- 4 Do not handle joint for five minutes and allow 24 hours drying time before testing or rough handling.

Please refer to page 8 for complete details on Clipsal Jointing Cement.

RIGID NON METALLIC CONDUIT

Light Duty Oval

Light Duty Oval Conduit products offer a range of low profile conduit specifically for use in chased walls. The low profile allows a minimum depth chase to be made yet still allows adequate space and protection for the cables. Available in Grey (GY) only.

Standard length - 4 metres.

Medium Duty

Medium Duty Conduit is used widely for an extensive range of cable protection applications. It is used for surface wiring as well as for inclusion in concrete slabs. Available in Grey (GY) only.

Standard length - 4 metres.

Heavy Duty

Heavy Duty Conduit is primarily used for underground applications. If installed in accordance with the specific clauses of AS/NZS 3000, it can be used for this application without further protection. Available in Orange (EO) only.

Standard length - 4 metres.

Rigid Non Metallic Conduit - Light Duty Oval			
Catalogue Number	Width (A)	Height (B)	Wall Thickness (C)
9016LOV	20mm	12mm	1.2mm
9020LOV	24mm	14mm	1.2mm

Rigid Non Metallic Conduit - Medium Duty			
Catalogue Number	Outside Diameter	Wall Thickness	Socket Length
9016MD	16mm	1.6mm	13mm
9020MD	20mm	1.8mm	16mm
9025MD	25mm	1.8mm	20mm
9032MD	32mm	2.1mm	25mm
9040MD	40mm	2.4mm	32mm
9050MD	50mm	2.8mm	40mm

Rigid Non Metallic Conduit - Heavy Duty			
Catalogue Number	Outside Diameter	Wall Thickness	Socket Length
9020HD	20mm	2.3mm	16mm
9025HD	25mm	2.5mm	20mm
9032HD	32mm	2.7mm	25mm
9040HD	40mm	3.1mm	32mm
9050HD	50mm	3.4mm	40mm
9063HD	63mm	3.9mm	50mm
9080HD	89mm	4.6mm	73mm
9100HD	114mm	5.9mm	99mm
9125HD	140mm	7.2mm	115mm
9150HD	160mm	8.3mm	124mm

Note: Nominal sizes of conduit 16 to 63mm refer to outside diameter, whereas sizes 80 to 150mm refer to the approximate internal diameter.

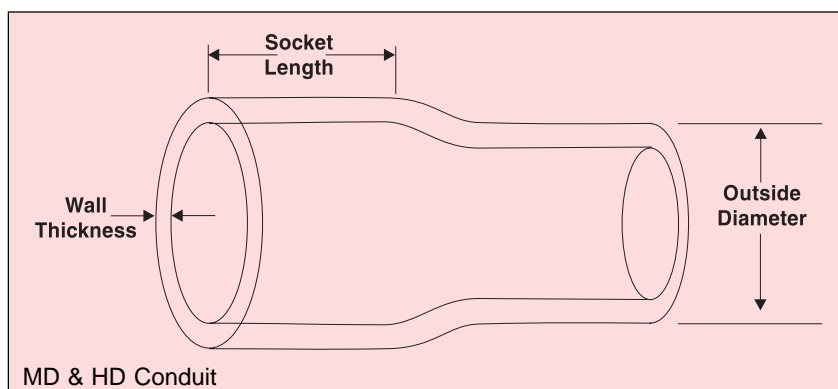
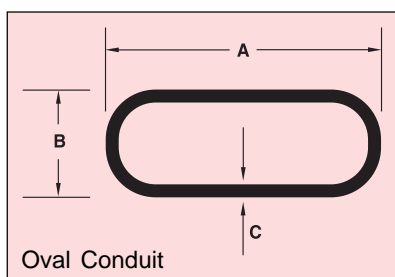

CORFLO PROFILE WALL, SMOOTH BORE CONDUIT

Clipsal Corflo is a profile wall, smooth bore conduit manufactured to AS/NZS 2053.6. If installed in accordance with the specific clauses of AS/NZS 3000, it can be used for this application without further protection.

Corflo is manufactured by a continuous, co-extrusion process which provides a seamless pipe that uses less material.

Less material means a lower cost and less weight, for ease of handling and transportation. Also available in White for communications applications. Standard length - 6 metres. Available in Orange (EO) only with the exception of Cat. No. C9100CF which comes in White Electric (WE).

Corflo Profile Wall, Smooth Bore Conduit

Catalogue Number	Size	Outside Diameter	Wall Thickness	Socket Length
9100CF	100mm	114mm	7mm	104mm
9125CF	125mm	140mm	6mm	115mm
9150CF	150mm	160mm	7mm	124mm
*C9100CF	100mm	114mm	7mm	104mm

* White Electric

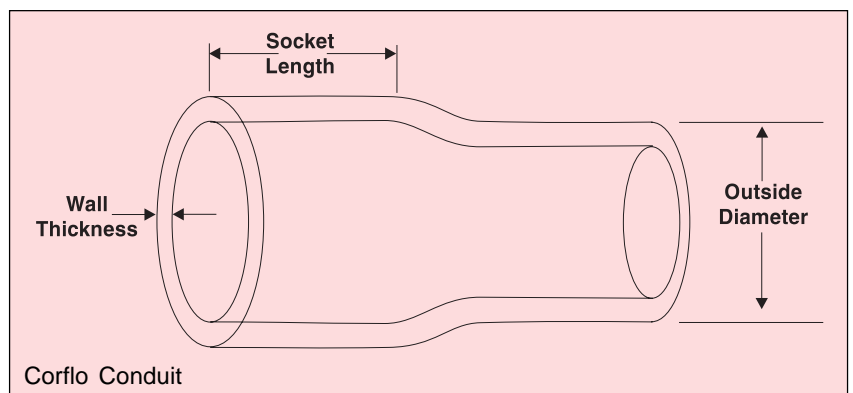

Corflo Conduit



TELECOMMUNICATIONS CONDUIT

Changes to regulations now require the Telecommunications industry to protect communications cabling in white conduit to AS 2053-ACA TS009.

Clipsal meets these requirements with a comprehensive range of white conduit and fittings that suits every application and enables telecommunications cabling to be instantly identified.

Clipsal Telecommunications Conduit and Fittings are manufactured from the same high quality, high impact material as our standard electrical fittings, and are UV and chemical resistant.

Telecommunications Conduit			
Cat. No.	Outside Diameter	Wall Thickness	Length
C9020	20mm	1.8mm	4m
C9020/3	20mm	1.8mm	3m
C9025	25mm	1.8mm	4m
C9025/3	25mm	1.8mm	3m
C9032	32mm	1.8mm	4m
C9032/3	32mm	1.8mm	3m
C9050	50mm	2.8mm	4m
C9080	80mm	3.7mm	6m
C9100	100mm	4.5mm	6m

Corflo in white for telecommunications use is also available. Please refer to Cat. No. C9100CF on page 6 for product dimensions.

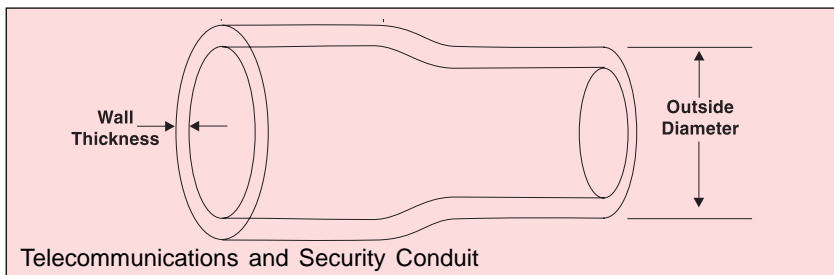

SECURITY CONDUIT

With the increasing need for certainty of integrity of data and security cabling systems, Clipsal now offers a range of transparent conduit and fittings.

Clipsal's Security Conduit and Fittings are specially designed for cabling systems used in high security areas for carrying highly sensitive or confidential data.

Being transparent, they enable the integrity of the cable to be inspected at all points along the route, ensuring that any damage or tampering is immediately identified.

Transparent conduit also ensures that a security conduit run isn't mistaken for electrical or other data and communications circuitry, and opened in error.

It also allows easy identification of entry of pests, vermin, moisture or other contaminants which may affect the performance of the system.

Normal clear Conduit Cement is ideal for bonding of the joints.



Security Conduit			
Cat. No.	Outside Diameter	Wall Thickness	Length
SC9016	16mm	1.6mm	4m
SC9020	20mm	1.8mm	4m
SC9025	25mm	1.8mm	4m
SC9032	32mm	2.1mm	4m
SC9040	40mm	2.4mm	4m
SC9050	50mm	2.8mm	4m

Refer to diagram above.

JOINTING CEMENT

Low Fume Safety Cement

Clipsal Medium Gap Filling Safety Jointing Cement is the result of our strong commitment to the preservation and protection of the environment.

Safer for the user and environment, this cement is a single low toxic biodegradable solvent that also offers improved bonding.

With virtually no smell or fumes, it is ideal for use in confined spaces or areas with poor ventilation.

Its convenient 125ml and 250ml twist top squeeze bottles enable 'no spill use' in the tightest situations and have high chemical stability and low flammability for safe transporting and storage.



PVC Solvent Cement Range

Clipsal Solvent Jointing Cements are benzene free for greater safety, thicker in consistency to avoid spillage, and packaged in long life, airtight storage containers.

They are available in blue and clear, in a choice of 4 container sizes, each with a brush incorporated into the lid. The clear cement is also available in a handy twist top 250ml squeeze bottle for no spill, safe handling.

Medium Gap Filling Safety Jointing Cement

Cat. No.	Volume
240/125GR	125ml squeeze bottle.
240/250GR	250ml squeeze bottle.

Medium Gap Filling Clear PVC Jointing Cement

Cat. No.	Volume
240A	250ml squeeze bottle.
240/125CL	125ml bottle with brush.
240/250CL	250ml bottle with brush.
240/500CL	500ml bottle with brush.
240/1000CL	1000ml bottle with brush.

Medium Gap Filling Blue PVC Jointing Cement

Cat. No.	Volume
240/125BU	125ml bottle with brush.
240/250BU	250ml bottle with brush.
240/500BU	500ml bottle with brush.
240/1000BU	1000ml bottle with brush.

Please refer to Halogen Free Technical Data Catalogue for information on HFT Jointing Cement.



240A



240/500CL



240/500BU

ACCESSORIES

Duct and Conduit Cutter

The 900TC is a sturdy Duct and Conduit Cutter that's easy to use and suitable for cutting a wide range of rigid PVC conduit, corrugated conduit, HFT conduit and mini trunking.

Replacement snap on anvils and blades ensure years of reliable use.



900TC

Duct and Conduit Cutter and Accessories	
Cat. No.	Description
900TC	Duct and Conduit Cutter suitable for cutting rigid PVC conduit up to 32mm HD or 40mm MD; light duty corrugated conduit mini trunking and HFT conduit.
900TCA	Replacement Snap on Anvil
900TCB	Replacement Blade

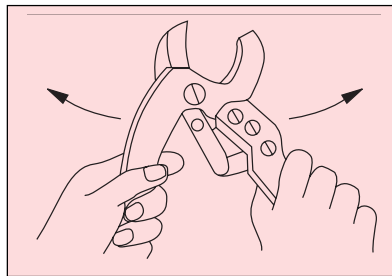

1. Open the handles wide to retract the blade.

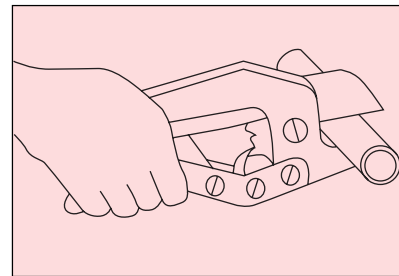

2. Place the material to be cut in the blade opening.

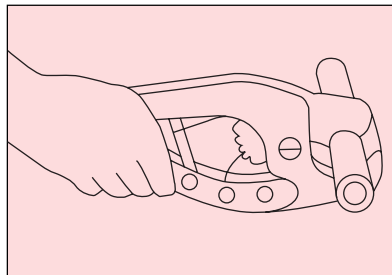

3. Squeeze handles together firmly. Relax the handles enough to allow the pawl to engage the next ratchet tooth and squeeze the handles together again. Continue ratcheting until the blade cuts through the material.

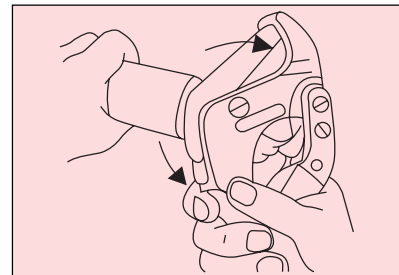

4. To chamfer the ID of material, leave the blade in the closed position, insert the heel of the blade into the cut end of the material and rotate the cutter.

Conduit Bending Springs

The easiest way to bend or set small bore conduit is with an Internal Bending Spring. Simply insert the relevant spring into the conduit and bend around your knee to the desired angle. It is often necessary to overbend to allow for creepage. Refer to the minimum recommended bend radii on page 4.

Conduit Bending Springs	
Cat. No.	Description
266MD16	For 16mm medium duty conduit.
266MD20	For 20mm medium duty conduit.
266MD25	For 25mm medium duty conduit.
266HD20	For 20mm heavy duty conduit.
266HD25	For 25mm heavy duty conduit.

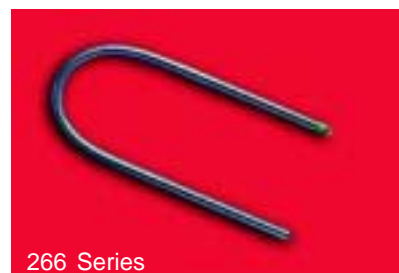

266 Series

NON METALLIC CONDUIT FITTINGS

Plain Conduit Entry Plugs

Plain Conduit Entry Plugs are used to neatly blank off unused plain entries in conduit junction boxes, weatherproof range enclosures and so on. If they are required to be permanent and watertight, they can be glued in with conduit jointing cement.

Standard colour is Grey (GY).
Orange (EO) available at extra cost.

Plain Conduit Entry Plugs

Catalogue Number	Outside Diameter (O.D.)	Length (L)
220/10	10mm	7mm
220/16	16mm	12mm
220/20	20mm	13mm
220/25	25mm	15.5mm

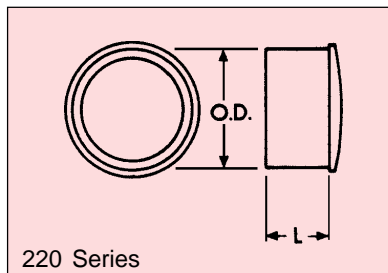

Screwed Conduit Entry Plugs

Screwed Conduit Entry Plugs are used to neatly blank off unused screwed entries in junction boxes, other wiring enclosures and so on. If they are required to be permanent and watertight, they can be glued in with conduit jointing cement.

Standard colour is Grey (GY).
Orange (EO) also available at extra cost.

Screwed Conduit Entry Plugs

Catalogue Number	Thread Size	Length (L)
220S20	20mm conduit	14mm
220S25	25mm conduit	17mm
220S32	32mm conduit	20mm
220S40	40mm conduit	23.5mm
220S50	50mm conduit	27mm

Nominal Dimensions.

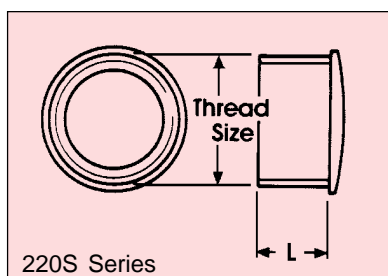

Conduit Caps

Conduit Caps are used to neatly blank off unused conduits. They ensure that no water, vermin or other debris can enter the conduit and make wiring difficult or the installation otherwise unsatisfactory. This is particularly important where the conduit is installed in a concrete pour, or underground applications. Conduit Caps can be made more secure and watertight by being glued with conduit jointing cement.

Standard colour is Grey (GY), except for larger sizes which come as standard in Orange (EO). Orange also available in other sizes at extra cost.

Conduit Caps				
Catalogue Number	Size	Inside Diameter (I.D.)	Outside Diameter (O.D.)	Length (L)
262/16	16mm	16mm	20mm	20mm
262/20	20mm	20mm	24mm	23mm
262/25	25mm	25mm	30mm	29mm
262/32	32mm	32mm	37mm	27mm
262/40	40mm	40mm	45mm	31mm
262/50	50mm	50mm	57mm	48mm
262/63	63mm	63mm	70mm	54mm
*262P80	80mm	89mm	96mm	43mm
*262P100	100mm	114.5mm	122mm	48mm
*262P150	150mm	160.5mm	168mm	53mm

* Standard colour - Orange.

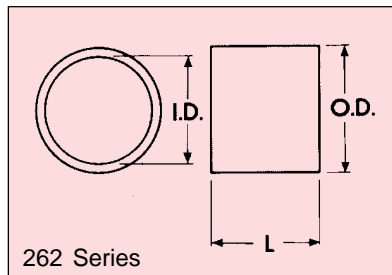

Imperial to Metric Plain Converters

Imperial to Metric Plain Converters allow interconnection of imperial conduit and accessories with the metric products now in use. Sizes available range from 3/4 inch to 2 inch, in both socket and spigot configurations.

Standard colour is Grey (GY). Orange (EO) available at extra cost.

Imperial to Metric Plain Converters				
Catalogue Number	Spigot Size (A)	Socket Size (I.D.)	Outside Diameter (O.D.)	Overall Length (L)
235/3/4/20	3/4"	20mm	25mm	47mm
235/1/25	1"	25mm	30mm	50mm
235/20/3/4	20mm	3/4"	25mm	47mm
235/25/1	25mm	1"	30mm	50mm
235/1 1/2/40	1 1/2"	40mm	45mm	60mm
235/2/50	2"	50mm	56mm	80mm
235/40/1 1/2	40mm	1 1/2"	45mm	60mm
235/50/2	50mm	2"	56mm	80mm

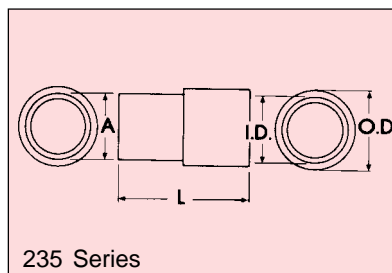

Imperial to Metric Screwed Converters

Imperial to Metric Screwed Converters allow interconnection of imperial threaded accessories with the metric equivalents. Sizes available range from 5/8 inch to 1 inch, in both socket and spigot configurations.

Standard colour is Grey (GY). Orange (EO) also available at extra cost.

Imperial to Metric Screwed Converters

Catalogue Number	Male Thread	Internal Thread	Outside Diameter (O.D.)	Length (L)
235S ^{5/8} /16	5/8"	16mm	21mm	30mm
235S ^{3/4} /16	3/4"	16mm	24mm	35mm
235S ^{3/4} /20	3/4"	20mm	25mm	33mm
235S1/25	1"	25mm	31mm	40mm
235S20 ^{5/8}	20mm	5/8"	24mm	35mm
235S20 ^{3/4}	20mm	3/4"	25mm	33mm
235S25/1	25mm	1"	31mm	36mm

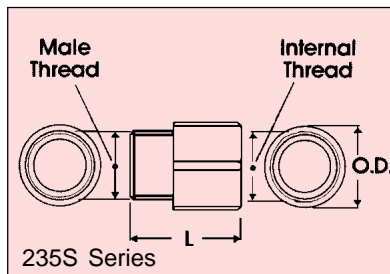

Converting Adaptors

Imperial to Metric Converting Adaptors allow interconnection between threaded and plain components of imperial conduit and accessories with the metric products now in use. Sizes available range from 5/8 inch to 1 inch, in both socket and spigot configurations.

Standard colour is Grey (GY). Orange (EO) available at extra cost.

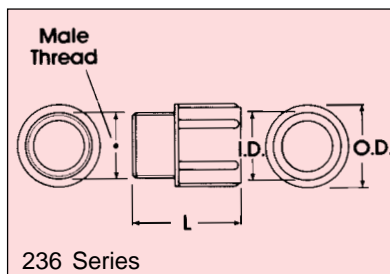

Converting Adaptors

Catalogue Number	Male Thread	Inside Diameter (I.D.)	Outside Diameter (O.D.)	Length (L)
236 ^{3/4} S16	3/4"	16mm	24mm	36mm
236 ^{3/4} S20	3/4"	20mm	25mm	36mm
236/1S25	1"	25mm	31mm	40mm
236/20S ^{5/8}	20mm	5/8"	24mm	36mm
236/20S ^{3/4}	20mm	3/4"	24mm	36mm
236/25S1	25mm	1"	31mm	40mm

PG/Metric Screwed Converters

This range of Clipsal Screwed Converters adapts metric conduit to European switchgear with PG threads to DIN 40430.

PG 13.5 and PG 16 have a thread pitch of 1.41. PG 21, PG 29, PG 36 and PG 42 have a thread pitch of 1.59.

Additional products are available in Clipsal's Metal Conduit Accessories Range.

PG/Metric Screwed Converters				
Catalogue Number	Male Thread	Female Thread	Outside Diameter (O.D.)	Length (L)
235SP13/20	PG 13.5	20mm	26mm	35mm
235SP16/20	PG 16	20mm	28mm	35mm
235SP21/20	PG 21	20mm	28mm	35mm
235SP29/32	PG 29	32mm	48mm	42mm
235S20P13	20mm	PG 13.5	28mm	30mm
235S20P16	20mm	PG 16	28mm	30mm
235S25P21	25mm	PG 21	37mm	37mm
235S40P36	40mm	PG 36	61mm	52mm
235S50P42	50mm	PG 42	68mm	54mm

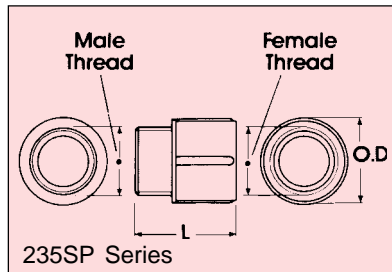

BSP/Metric Screwed Converters

Clipsal offers a limited range of non Metallic BSP to Metric Screwed Converters that allow interconnection of water pipe accessories with the metric products. Additional products are available in Clipsal's Metal Conduit Accessories Range. BSP products have a thread pitch of 2.31.

Standard colour is Grey (GY). Orange (EO) available at extra cost.

BSP/Metric Screwed Converters				
Catalogue Number	Male Thread	Female Thread	Outside Diameter (O.D.)	Length (L)
235S32BSP25	32BSP	25mm	47mm	40mm
235S32BSP40	32BSP	20mm	47mm	49mm

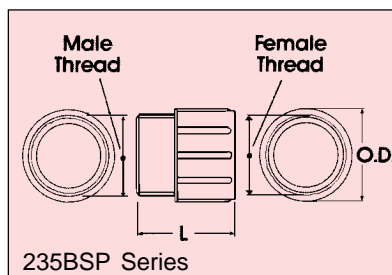

Plain to Screwed Adaptors

Plain to Screwed Adaptors allow rigid conduit to be terminated into an enclosure and secured with a lock ring or lock nut. They are available for conduit sizes 16mm through to 100mm. Lock rings are supplied with 80mm and 100mm sizes.

Standard colour is Grey (GY), except for larger sizes which come as standard in Orange (EO). Orange also available in other sizes at extra cost.

Plain to Screwed Adaptors

Catalogue Number	Male Thread	Inside Diameter (I.D.)	Outside Diameter (O.D.)	Length (L)
263/16	16mm	16mm	21mm	30mm
263/20	20mm	20mm	25mm	36mm
263/25	25mm	25mm	32mm	42mm
263/32	32mm	32mm	38mm	48mm
263/40	40mm	40mm	47mm	58mm
263/50	50mm	50mm	59mm	68mm
*263/63	63mm	63mm	71mm	79mm
*263P80	80mm BSP	89mm	105mm	100mm
*263P100	100mm BSP	114.5mm	134mm	120mm

*Standard colour - Orange.

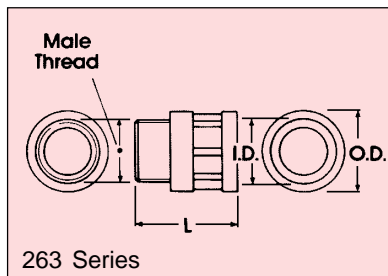

Plain Couplings

Plain Couplings allow joining of two lengths of conduit of the same size.

Standard colour is Grey (GY), except for larger sizes which come as standard in Orange (EO). Orange also available in other sizes at extra cost.

Plain Couplings

Catalogue Number	Size	Inside Diameter (I.D.)	Outside Diameter (O.D.)	Length (L)
242/16	16mm	16mm	20mm	38mm
242/20	20mm	20mm	25mm	42mm
242/25	25mm	25mm	30mm	42mm
242/32	32mm	32mm	37mm	52mm
242/40	40mm	40mm	45mm	58mm
242/50	50mm	50mm	57mm	80mm
*242/63	63mm	63mm	71mm	150mm
*242P80	80mm	89mm	98mm	172mm
*242P100	100mm	114.5mm	127mm	228mm
*242P125	125mm	140mm	154mm	230mm
*242P150	150mm	160.5mm	177mm	367mm

*Standard colour - Orange.

Certification of Suitability No. CS/188/S.

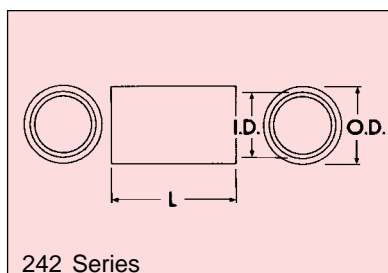

Round to Oval Couplings

Round to Oval Couplings allow interconnection between the two types of conduit.

Available in Grey only.

Round to Oval Couplings					
Catalogue Number	Inside Diameter (I.D.)	Outside Diameter (O.D.)	Interior Dimensions	Exterior Dimensions	Length (L)
250/16/16	16mm	21mm	20 x 9mm	25 x 14mm	43mm
250/20/16L	20mm	24mm	20 x 12mm	24 x 16mm	51mm
250/20/20L	20mm	25mm	24 x 14mm	29 x 19mm	51mm

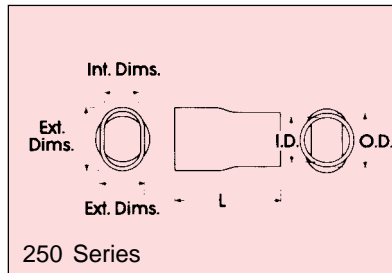

Slip Type Expansion Couplings

Where long conduit runs are likely to be exposed to wide variations in temperature, it is recommended that expansion couplings be used at each join. Slip Type Expansion Couplings are available from 16mm through to 50mm. It is not recommended that Slip Type Expansion Couplings be used where the conduit run is exposed to the weather.

Standard colour is Grey (GY). Orange (EO) available at extra cost.

Slip Type Expansion Couplings					
Catalogue Number	Spigot Diameter (A)	Socket Diameter (I.D.)	Outside Diameter (O.D.)	Length (max.) (L)	Length (min.) (L)
251/16	16mm	16mm	20mm	70mm	57mm
251/20	20mm	20mm	25mm	76mm	63mm
251/25	25mm	25mm	30mm	88mm	71mm
251/32	32mm	32mm	37mm	95mm	79mm
251/40	40mm	40mm	45mm	104mm	87mm
251/50	50mm	50mm	57mm	144mm	118mm

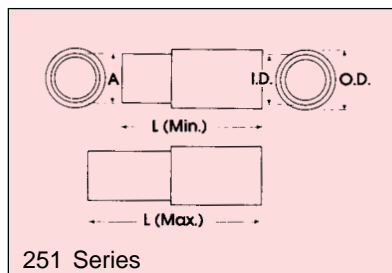

Flexible Expansion Couplings

Where long conduit runs are likely to be exposed to wide variations in temperature, it is recommended that expansion couplings be used at each join. Flexible Expansion Couplings are available from 16mm through to 50mm.

Available in Grey (GY) only.

Flexible Expansion Couplings

Catalogue Number	Inside Diameter (I.D.)	Outside Diameter (O.D.)	Length (L)
F251/16	16mm	20mm	64mm
F251/20	20mm	24mm	71mm
F251/25	25mm	31mm	81mm
F251/32	32mm	37mm	98mm
F251/40	40mm	45mm	112mm
F251/50	50mm	56mm	128mm

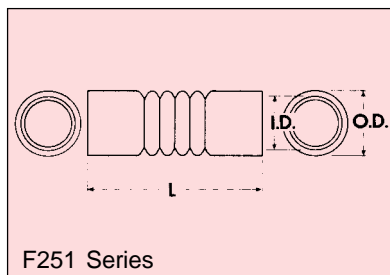

Plain to Screwed Couplings

These Couplings allow socket to socket interconnection between plain and threaded conduit and accessories of the same size.

Standard colour is Grey (GY). Orange (EO) available at extra cost.

Plain to Screwed Couplings

Catalogue Number	Female Thread (I.D.)	Outside Diameter (O.D.)	Length (L)
258/16	16mm	20mm	28mm
258/20	20mm	26mm	34mm
258/25	25mm	30mm	34mm
258/32	32mm	37mm	37mm
258/40	40mm	45mm	46mm
258/50	50mm	56mm	59mm

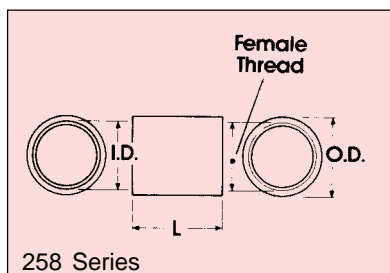

Plain to Flexible Coupling Adaptors

Plain to Flexible Coupling Adaptor Sets facilitate interconnection between rigid conduit and flexible conduit of the same size. The set is comprised of a 242 coupling, a 263F barbed adaptor to fit inside the flexible conduit, and a clamp band to lock the flexible conduit in place. They are available in 16mm, 20mm and 25mm sizes. Available in Grey (GY) only.

Plain to Flexible Coupling Adaptors	
Cat. No.	Description
263F16	Interconnects 16mm rigid pipe with 16mm flexible hose.
263F20	Interconnects 20mm rigid pipe with 20mm flexible hose.
263F25	Interconnects 25mm rigid pipe with 25mm flexible hose.

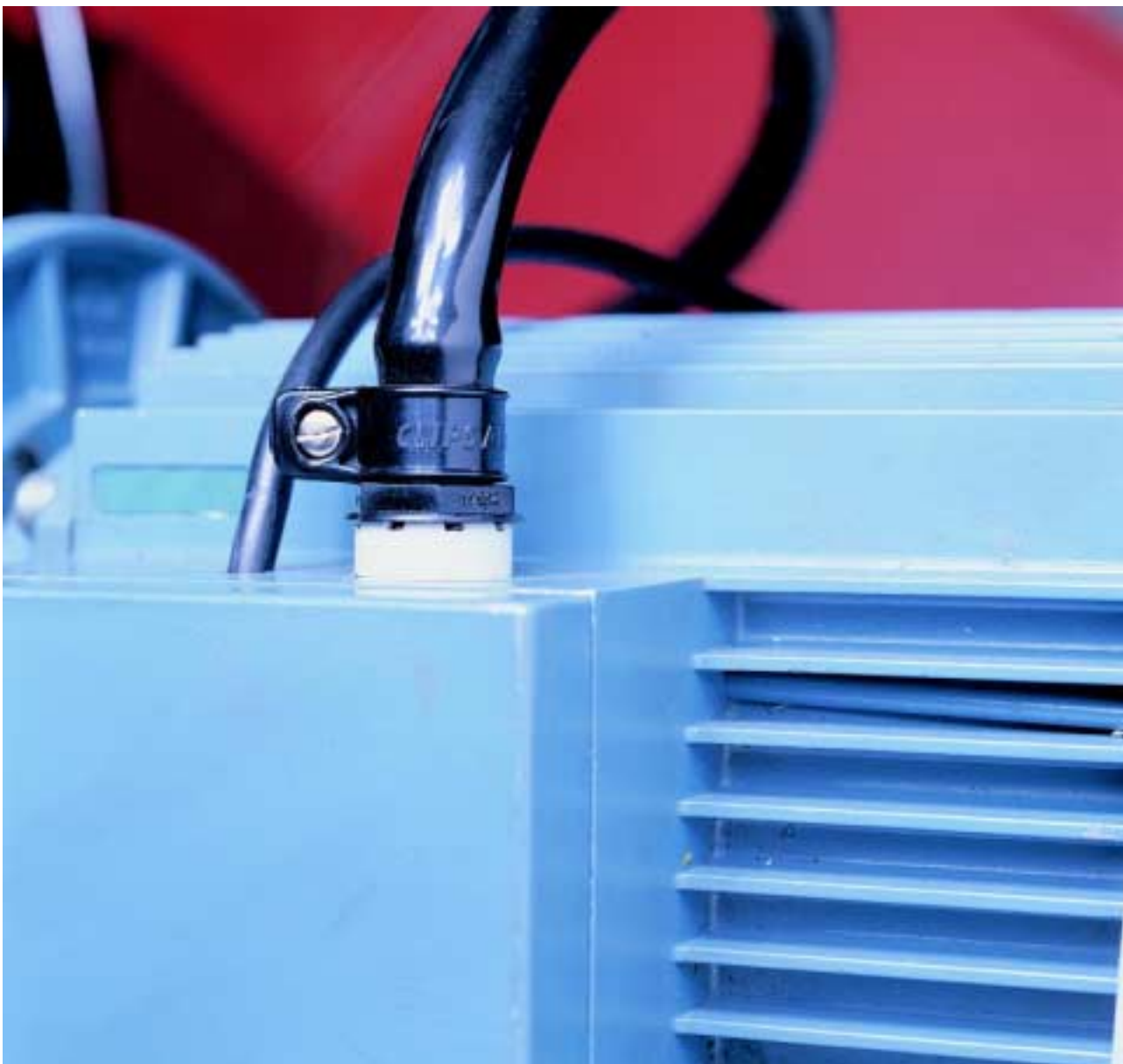

Coupling Adaptor Sets - Reducing Type

Plain to Flexible Coupling Adaptor Sets (Reducing type) facilitate interconnection between rigid conduit and flexible conduit of the different sizes. The sets comprise a 242 coupling, a 264 reducer, a 263F barbed adaptor to fit inside the flexible conduit, and a clamp band to lock the flexible conduit in place. They are available in 20mm and 25mm sizes.

Available in Grey (GY) only.

Coupling Adaptor Sets - Reducing Type

Cat. No.	Description
263F20R	Barbed end fits 16mm flexible conduit. Plain end suits 20 - 16mm reducer to accept 20mm conduit entry.
263F25R	Barbed end fits 20mm flexible conduit. Plain end suits 25 - 20mm reducer to accept 25mm conduit entry.



263F20R

Duplex Junction Box Entries

Duplex Junction Box Entries allow for two lengths of conduit to be brought into one conduit junction box entry. This can be advantageous when preparing conduit for a concrete pour where extra conduit needs to be accommodated. Care should be taken to ensure that there is sufficient space in the neck of the entry to accommodate the necessary cables.

Available in Grey (GY) only.

Duplex Junction Box Entries

Catalogue Number	Spigot Diameter (A)	Inside Diameter (I.D.)	Outside Diameter (O.D.)	Length (L)
263Y20	20mm	20mm	24mm	61mm
263YR20	20mm	16mm	23mm	67mm
263YR25	25mm	20mm	24mm	67mm

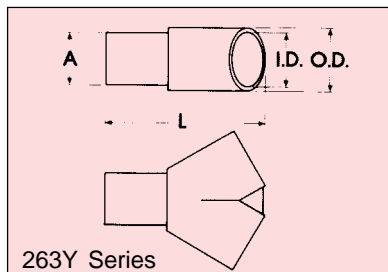

263Y Series



263Y Series

Threaded Nipples

243 Series Threaded Plastic Nipples are available in sizes 16mm through to 50mm. They are compatible with all other threaded metric accessories including products in the Metal Conduit Accessories Range. Clipsal also offers threaded nipples in brass and plated steel. Please refer to the Metal Conduit Fittings Technical Data Catalogue for more information.

Standard colour is Grey (GY). Orange (EO) available at extra cost.

Threaded Nipples			
Cat. No.	Thread Size	Inside Diameter (I.D.)	Length (L)
243/16	16mm	11mm	28mm
243/20	20mm	14mm	30mm
243/25	25mm	18mm	32mm
243/32	32mm	26mm	36mm
243/40	40mm	33mm	40mm
243/50	50mm	42mm	50mm

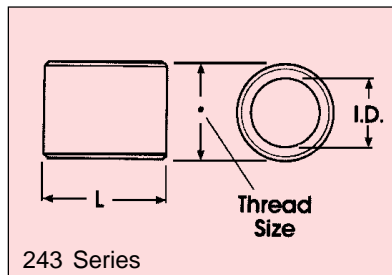

Plain Reducers

Plain Reducers allow joining of two lengths of conduit of adjacent sizes. As there is a stop lip in the socket, ensure that the reducer is inserted in the correct orientation prior to gluing.

Standard colour is Grey (GY). Orange (EO) available at extra cost.

Plain Reducers					
Cat. No.	Size	Outside Diameter (O.D.)	Inside Diameter (I.D.)	Through Diameter (A)	Length (L)
264/1M	20 - 16mm	20mm	16mm	13mm	22mm
264/2M	25 - 20mm	25mm	20mm	17mm	25mm
264/3M	32 - 25mm	32mm	25mm	22mm	26mm
264/4M	40 - 32mm	40mm	32mm	30mm	32mm
264/5M	50 - 40mm	50mm	40mm	36mm	35mm

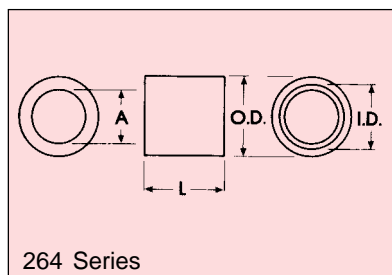

Threaded Reducers

Threaded Reducers allow joining of two threaded accessories of adjacent sizes.

Standard colour is Grey (GY).
Orange (EO) available at extra cost.

Threaded Reducers

Catalogue Number	Size	External Thread	Internal Thread	Length (L)
264/1SM	20 - 16mm	20mm	16mm	19mm
264/2SM	25 - 20mm	25mm	20mm	22mm
264/3SM	32 - 25mm	32mm	25mm	25mm
264/4SM	40 - 32mm	40mm	32mm	29mm
264/5SM	50 - 40mm	50mm	40mm	32mm

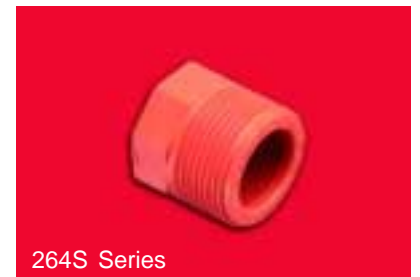
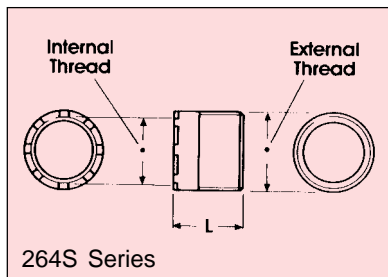

Hexagonal Lock Nuts

Lock Nuts are compatible with all threaded conduit accessories and are available in sizes 16mm through to 50mm.

Only available in Black. Moulded in Black Nylon.

Hexagonal Lock Nuts

Catalogue Number	Internal Thread	Outside Diameter (O.D.)	Grip Size (A.F.)	Depth (H)
259/16	16mm	27mm	24mm	6mm
259/20	20mm	33mm	28mm	6.5mm
259/25	25mm	40mm	33mm	7mm
259/32	32mm	46mm	40mm	8mm
259/40	40mm	57mm	49mm	10mm
259/50	50mm	69mm	60mm	12mm

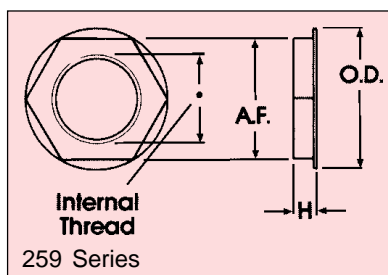

Screwed Lock Rings

Lock Rings are compatible with all threaded conduit accessories and are available in sizes 16mm through to 100mm.

Standard colour is Grey (GY), except for larger sizes which come as standard in Orange (EO). Orange also available in other sizes at extra cost.

Screwed Lock Rings			
Cat. No.	Internal Thread	Outside Diameter (O.D.)	Depth (H)
260/16	16mm	25mm	4.6mm
260/20	20mm	29mm	6.2mm
260/25	25mm	34mm	5.0mm
260/32	32mm	40mm	9.5mm
260/40	40mm	50mm	11mm
260/50	50mm	60mm	12.5mm
*260/63	63mm	75mm	10mm
*260P80	80mm BSP	112mm	20mm
*260P100	100mm BSP	140mm	24mm

*Standard colour - Orange.

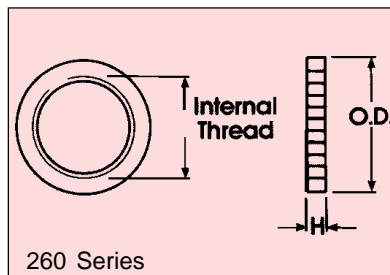

Male Conduit Bushes

Male Conduit Bushes are ideal for the protection of cables passing through metal boxes and panels. They can be used in conjunction with 281F Female Conduit Bushes or with threaded couplings, lock nuts or lock rings.

Standard colour is Grey (GY). Orange (EO) available at extra cost.

Male Conduit Bushes					
Cat. No.	Thread	Through Size (I.D.)	Outside Diameter (O.D.)	Grip Size (A.F.)	Length (L)
281/16	16mm	11mm	23mm	20mm	14mm
281/20	20mm	14mm	26.5mm	23mm	14mm
281/25	25mm	20mm	32mm	28mm	14mm
281/32	32mm	26.5mm	39.5mm	34mm	14mm
281/40	40mm	34mm	48mm	42mm	21mm
281/50	50mm	43mm	57mm	50mm	21mm

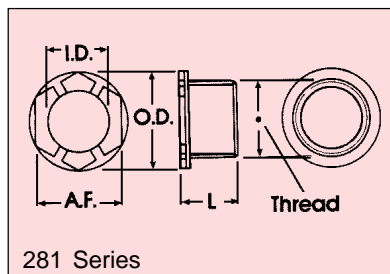

Female Conduit Bushes

Female Conduit Bushes are ideal for the protection of cables passing through metal boxes and panels. They can be used in conjunction with 281 Series Male Conduit Bushes or with threaded nipples or conduit.

Standard colour is Grey (GY). Orange (EO) available at extra cost.

Female Conduit Bushes				
Cat. No.	Thread	Outside Diameter (O.D.)	Grip Size (A.F.)	Length (L)
281F16	16mm	23mm	20mm	14mm
281F20	20mm	26.5mm	23mm	14mm
281F25	25mm	32mm	28mm	14mm
281F32	32mm	39.5mm	34mm	14mm
281F40	40mm	48mm	42mm	20mm
281F50	50mm	57mm	50mm	20mm

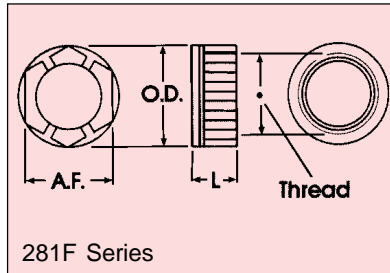

Conduit Locating Flanges

Conduit Locating Flanges are an ideal way of securing conduit turn downs to formwork. They hold the conduit in place during the concrete pour and allow easy identification and retrieval afterwards.

Standard colour is Orange (EO).

Conduit Locating Flanges				
Cat. No.	Conduit Size	Outside Diameter (O.D.)	Height (H)	Fixing Diameter (P.C.D)
221/20	20mm	90mm	40mm	80mm
221/25	25mm	90mm	40mm	80mm
221/32	32mm	90mm	40mm	80mm

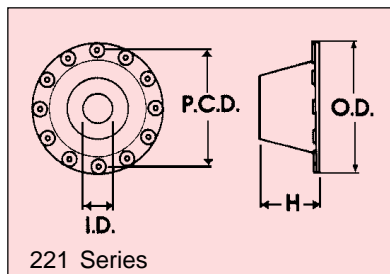

Conduit Bell Mouths and Bell Mouth Couplings

Conduit Bell Mouths and Bell Mouth Couplings are designed to chamfer the ends of conduit runs to protect the cables as they are drawn in. The Bell Mouths fit inside a standard coupling, and the Bell Mouth Couplings fit over a plain conduit end. They are available in sizes 50mm through to 150mm (125mm to special order).

Available only in Orange (EO).

Conduit Bell Mouth	
Catalogue Number	Outside Diameter
288/50	50mm
288/63	63mm
288/80	80mm
288/100	100mm
288/150	150mm

Bell Mouth Coupling	
Catalogue Number	Outside Diameter
288/50C	50mm
288/63C	63mm
288/80C	80mm
288/100C	100mm
288/150C	150mm



90° Inspection Elbows

The 244 Series is a range of 90 degree Inspection Elbows from 16mm through to 63mm. The design allows the elbow to fit into corners neatly, and the inspection cover removes to allow easy wiring and rewiring.

Standard colour is Grey (GY) for sizes up to 50mm with Orange (EO) also available at extra cost. The 244/63 is fabricated from an adaptable box and adaptors, and is standard in Orange (EO). A limited range of Inspection Elbows is also available for Communication Conduit and Security Conduit.

Please refer to page 45.

90° Inspection Elbows				
Catalogue Number	Size (I.D.)	Overall Length (A)	Overall Length (B)	Height (H) (incl. Lid)
244/16	16mm	59mm	59mm	28mm
244/20	20mm	59mm	59mm	28mm
244/25	25mm	66mm	66mm	35mm
244/32	32mm	80mm	80mm	41mm
244/40	40mm	95mm	95mm	50mm
244/50	50mm	119mm	119mm	62mm
244/63	63mm	265mm	162mm	107mm

Certificate of Suitability No. CS/189/S.

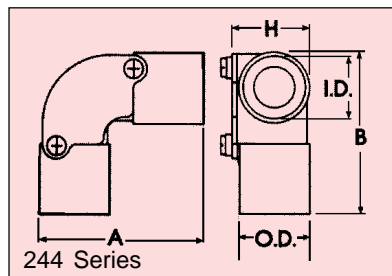

90° Solid Elbows

The 245 Series is a range of 90 degree Solid Elbows from 16mm through to 25mm. The design allows the elbow to fit into corners neatly.

Standard colour is Grey (GY) with Orange (EO) also available at extra cost. An 80mm elbow is also available, standard colour Orange (EO).

A limited range of Solid Elbows is available for Communication Conduit and Security Conduit.

Please refer to pages 44 and 48 respectively.

90° Solid Elbows			
Catalogue Number	Size (I.D.)	Overall Length (A)	Radius (R)
245/16	16mm	50mm	18mm
245/20	20mm	54mm	22mm
245/25	25mm	66mm	28mm
*245P80	80mm	390mm	230mm

*Standard colour - Orange.

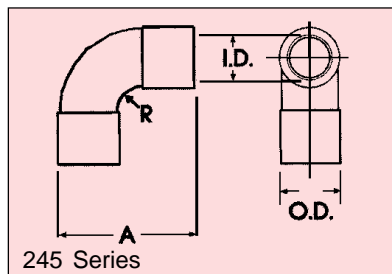

Inspection Tees

The 246 Series is a range of Inspection Tees from 16mm through to 63mm. The screw fixed inspection cover removes to allow easy wiring and rewiring. The 246C20 is a clip-on lid version. The lid is removed by inserting a screwdriver in the tab slots and levering.

Standard colour is Grey (GY) for sizes up to 50mm with Orange (EO) also available at extra cost.

The 246/63 is fabricated from an adaptable box and adaptors, is standard in Orange (EO). A limited range of Inspection Elbows is also available for Communication Conduit and Security Conduit.

Inspection Tees				
Catalogue Number	Size (I.D.)	Tee Off Length (A)	In Line Length (B)	Height (incl. Lid) (H)
246/16	16mm	55mm	92mm	29mm
246/20	20mm	55mm	92mm	29mm
246C20	20mm	55mm	92mm	29mm
246/25	25mm	69mm	108mm	37mm
246/32	32mm	82mm	127mm	44mm
246/40	40mm	94mm	145mm	50mm
246/50	50mm	120mm	180mm	62mm
246/63	63mm	162mm	319mm	107mm

Certificate of Suitability No. CS/190/S.

*246C20 includes clip-on lid.

**Standard colour - Orange.

Note: Cat. No. 246/63 fabricated from a non metallic box and three 263/63 Adaptors with lock nuts.

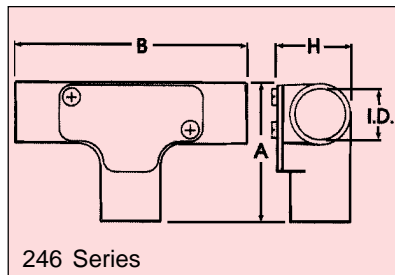

BENDS

The 247 Series Conduit Bends Range is available in short radius standard bends and large radius sweep bends. The Sweep Bends are available in both 45 degree and 90 degree forms. All are suitable for underground use.

90° Bends

The range of Standard Bends is from 16mm through to 63mm. The 247C20 is a clip-on lid version. The lid is removed by inserting a screwdriver in the tab slots and levering.

Standard colour is Grey (GY) for sizes up to 50mm with Orange (EO) also available at extra cost. The 246/63 is standard in Orange (EO). A limited range of Standard Bends is also available for Communication Conduit and Security Conduit.

Please refer to pages 46 and 48.

90° Bends			
Catalogue Number	Size (I.D.)	Length (A)	Radius (R)
247/16	16mm	68mm	41mm
247/20	20mm	83mm	47mm
247C20	20mm	83mm	47mm
247/25	25mm	106mm	64mm
247/32	32mm	134mm	83mm
247/40	40mm	155mm	100mm
247/50	50mm	205mm	120mm
247/63	63mm	258mm	166mm

Certificate of Suitability No. CS/191/S.

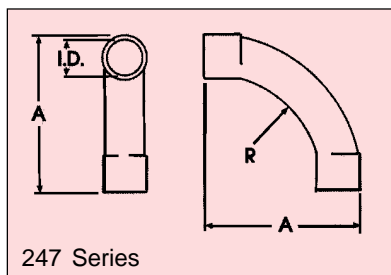

45° Large Sweep Bends

Available in a range of sizes from 20mm to 150mm.

Standard colour Orange (EO).

45° Large Sweep Bends					
Catalogue Number	Size	Inside Diameter (I.D.)	Radius (R)	Overall Height (A)	Overall Length (B)
247LH20	20mm	20mm	150mm	76mm	145mm
247LH25	25mm	25mm	150mm	78mm	157mm
247LH32	32mm	32mm	312mm	135mm	270mm
247LH40	40mm	40mm	312mm	145mm	280mm
247LH50	50mm	50mm	320mm	170mm	310mm
247LH63	63mm	63mm	325mm	190mm	357mm
247PH80	80mm	89mm	580mm	330mm	610mm
247PH100	100mm	114.5mm	715mm	410mm	750mm
247PH125	125mm	140.4mm	600mm	420mm	850mm
247PH150	150mm	160.5mm	870mm	538mm	1040mm

Standard colour - Orange.

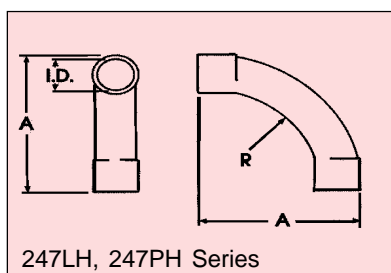

90° Large Sweep Bends

Available in a range of sizes from 20mm to 150mm sizes.

Standard colour Orange (EO). A limited range is also available in White for Communication Conduit.

Please refer to page 46.

90° Large Sweep Bends

Catalogue Number	Size	Inside Diameter (I.D.)	Radius (R)	Overall Length (A)
247L20	20mm	20mm	150mm	185mm
247L25	25mm	25mm	150mm	192mm
247L32	32mm	32mm	312mm	350mm
247L40	40mm	40mm	312mm	355mm
247L50	50mm	50mm	320mm	360mm
247L63	63mm	63mm	325mm	400mm
247P80	80mm	89mm	550mm	660mm
247P100	100mm	114.5mm	600mm	900mm
247P125	125mm	140.4mm	600mm	960mm
247P150	150mm	160.5mm	760mm	1050mm

Standard colour - Orange.

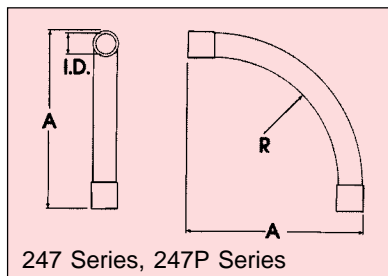

JUNCTION BOXES 16MM TO 25MM

The 240 Series Junction Boxes are available in standard and tangential formats (20 and 25mm only), as well as in shallow and deep configurations. There are also some with lids, top and bottom, some top entry models, and a two piece tee off box which is ideal for additions to an existing installation.

All cover fixing screws are 3/16" B.S.W.

Certificate of Suitability
No. CS/187/S.

240 Series Standard Shallow Junction Boxes

These are the traditional surface wiring conduit boxes. They are available in 16mm, 20mm, and 25mm in 1 through 4 way.

Standard colour is Grey (GY) with Orange (EO) also available at extra cost.

With 16mm Entries	
Cat. No.	Description
240/16/1	Standard type with 1 way entry.
240/16/2	Standard type with 2 way through entries.
240/16/2A	Standard type with 2 way angle entries.
240/16/3	Standard type with 3 way entries.
240/16/4	Standard type with 4 way entries.

With 20mm Entries	
Cat. No.	Description
240/20/1	Standard type with 1 way entry.
240/20/2	Standard type with 2 way through entries.
240/20/2S1	Standard type with 2 way through entries 1 x 20mm plain entry, 1 x 20mm screwed entry.
240/20/2A	Standard type with 2 way angle entries.
240/20/3	Standard type with 3 way entries.
240/20/4	Standard type with 4 way entries.

With 25mm Entries	
Cat. No.	Description
240/25/1	Standard type with 1 way entry.
240/25/2	Standard type with 2 way through entries.
240/25/2A	Standard type with 2 way angle entries.
240/25/3	Standard type with 3 way entries.
240/25/4	Standard type with 4 way entries.

240 Series Shallow Junction Boxes			
Cat. No.	Diameter (O.D.)	Height (H)	Screw Centres (Crs.)
240 Series Shallow Junction Boxes	66mm	42mm	50mm

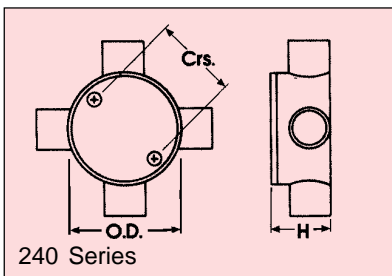

Entry Arrangement	
1 Way	2 Way
3 Way	4 Way
2 Way Angle	

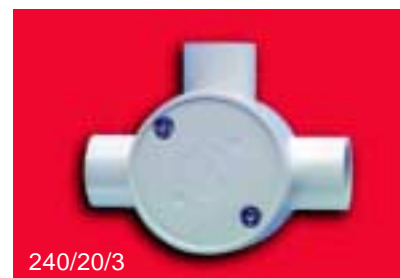

CT240 Clip Together Junction Box

Available only in 20mm 3 way, this clip together box is ideal for additions to an existing conduit run. Remove the lid and unclip the two halves of the box, remove a section of the conduit in the desired position, slip the base of the box under the cut out section. Add the additional wiring, clip the top in place and secure the lid.

Standard colour is Grey (GY) with Orange (EO) also available at extra cost.

T240 Series Tangential Shallow Junction Boxes

Tangential Boxes are unique to the Clipsal range. They are available in 20mm and 25mm, 1 through 4 way and offer much improved versatility and convenience for surface wiring applications.

Standard colour is Grey (GY) with Orange (EO) also available at extra cost.

CT240 Clip Together Junction Box

Cat. No.	Description
CT240/20/3	2 piece, 3 way T-Type Junction Box.

With 20mm Entries

Cat. No.	Description
T240/1R/20	Tangential Box with 1 way right hand entry.
T240/1L/20	Tangential Box with 1 way left hand entry.
T240/2U/20	Tangential Box with 2 way 'U' entries.
T240/2A/20	Tangential Box with 2 way angle entries.
T240/2/20	Tangential Box with 2 way through entries.
T240/3Y/20	Tangential Box with 3 way 'Y' entries.
T240/3T/20	Tangential Box with 3 way 'T' entries.
T240/4H/20	Tangential Box with 4 way 'H' entries.

With 25mm Entries

Cat. No.	Description
T240/1R/25	Tangential Box with 1 way right hand entry.
T240/1L/25	Tangential Box with 1 way left hand entry.
T240/2U/25	Tangential Box with 2 way 'U' entries.
T240/2A/25	Tangential Box with 2 way angle entries.
T240/2/25	Tangential Box with 2 way through entries.
T240/3Y/25	Tangential Box with 3 way 'Y' entries.
T240/3T/25	Tangential Box with 3 way 'T' entries.
T240/4H/25	Tangential Box with 4 way 'H' entries.

Certificate of Suitability No. CS/703/S



T240 Series

Entry Arrangement

1 Way Right	1 Way Left	2 Way Angle
2 Way 'U' Type	2 Way Through	3 Way 'Y' Type
3 Way 'T' Type	4 Way 'H' Type	4 Way 'H' with 2 Way Through
		Deep Type Only

240D Series Standard Deep Junction Boxes

The Deep Junction Box Series is designed primarily for inclusion in concrete pours. The design allows the face of the box to sit on the formwork and leave the entries well clear of the bottom steel reinforcing. They are available in 16mm, 20mm, and 25mm in 1 through 4 way.

Standard colour is Grey (GY) with Orange (EO) also available at extra cost.

Entry arrangements same as 240 Series.



240D Series

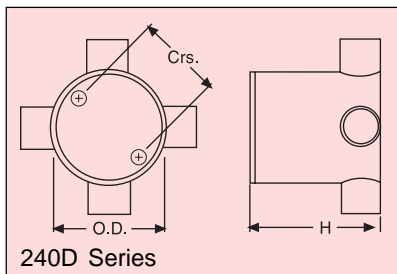

240D Series

240DE Series Double End Deep Junction Boxes

These Junction Boxes are the same design as the standard Deep Boxes with the exception of having lids both top and bottom. This type is used where there is a desire to install the conduit and boxes on the deckwork and then install the cables prior to pouring of the slab. They are available in 16mm, 20mm, and 25mm in 1 through 4 way.

Standard colour is Grey (GY) with Orange (EO) also available at extra cost.

Fixing screw thread - $\frac{3}{16}$ " BSW. Certificate of Suitability No. CS/187/S.

Entry arrangements same as 240 Shallow Series.

With 16mm Entries	
Cat. No.	Description
240/16/1D	Deep type with 1 way entry.
240/16/2D	Deep type with 2 way through entries.
240/16/2AD	Deep type with 2 way angle entries.
240/16/3D	Deep type with 3 way entries.
240/16/4D	Deep type with 4 way entries.

With 20mm Entries	
Cat. No.	Description
240/20/1D	Deep type with 1 way entry.
240/20/2D	Deep type with 2 way through entries.
240/20/2AD	Deep type with 2 way angle entries.
240/20/3D	Deep type with 3 way entries.
240/20/4D	Deep type with 4 way entries.

With 25mm Entries	
Cat. No.	Description
240/25/1D	Deep type with 1 way entry.
240/25/2D	Deep type with 2 way through entries.
240/25/2AD	Deep type with 2 way angle entries.
240/25/3D	Deep type with 3 way entries.
240/25/4D	Deep type with 4 way entries.

240 Series Deep Junction Boxes			
Cat. No.	Diameter (O.D.)	Height (H)	Screw Centres
240 Series Deep Junction Boxes	66mm	72mm	50mm

With 16mm Entries	
Cat. No.	Description
240/16/1DE	Deep type with two lids and 1 way entry.
240/16/2DE	Deep type with 2 way through entries.
240/16/2ADE	Deep type with 2 way angle entries.
240/16/3DE	Deep type with 3 way entries.
240/16/4DE	Deep type with 4 way entries.

With 20mm Entries	
Cat. No.	Description
240/20/1DE	Deep type with two lids and 1 way entry.
240/20/2DE	Deep type with 2 way through entries.
240/20/2ADE	Deep type with 2 way angle entries.
240/20/3DE	Deep type with 3 way entries.
240/20/4DE	Deep type with 4 way entries.

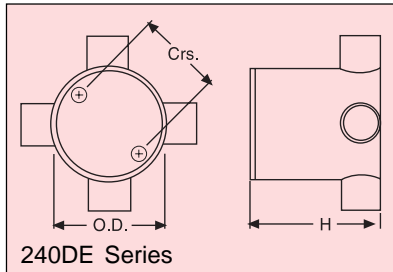

With 25mm Entries

Cat. No.	Description
240/25/1DE	Deep type with two lids and 1 way entry.
240/25/2DE	Deep type with 2 way through entries.
240/25/2ADE	Deep type with 2 way angle entries.
240/25/3DE	Deep type with 3 way entries.
240/25/4DE	Deep type with 4 way entries.

240DE Series Junction Boxes

Cat. No.	Diameter (O.D.)	Height (H)	Screw Centres
240DE Series Junction Boxes	66mm	76mm	50mm

TD240 Series Tangential Deep Junction Boxes

Deep Tangential Boxes combine the advantages of standard deep junction boxes with the unique benefits of Clipsal's tangential range. They are available in 20mm and 25mm 1 through 4 way.

Standard colour is Grey (GY) with Orange (EO) also available at extra cost.

Fixing screw thread - $\frac{3}{16}$ " BSW.
Certificate of Suitability No. CS/703/S.

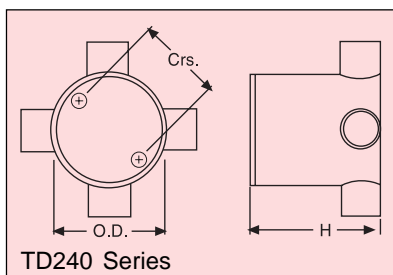

With 20mm Entries

Cat. No.	Description
TD240/2/20	Deep type with 2 way through entries.
TD240/2A/20	Deep type with 2 way angle entries.
TD240/3T/20	Deep type with 3 way 'T' entries.
TD240/3Y/20	Deep type with 3 way 'Y' entries.
TD240/4H/20	Deep type with 4 way 'H' entries.
TD240/6R/20	Deep type with 4 way 'H' entries and 2 x 25mm central through entries.

With 25mm Entries

Cat. No.	Description
TD240/2/25	Deep type with 2 way through entries.
TD240/2A/25	Deep type with 2 way angle entries.
TD240/3T/25	Deep type with 3 way 'T' entries.
TD240/3Y/25	Deep type with 3 way 'Y' entries.
TD240/4H/25	Deep type with 4 way 'H' entries.

TD240 Series Junction Boxes

Cat. No.	Diameter (O.D.)	Height (H)	Screw Centres
TD240 Series Junction Boxes	66mm	72mm	50mm



Top Entry Deep Junction Boxes

Top Entry Boxes are an adaptation of our standard deep boxes to allow installation into pre-formed concrete installations. They are available in 2 way and 4 way only.

Standard colour is Grey (GY) with Orange (EO) also available at extra cost.

Fixing screw threads - $\frac{3}{16}$ " BSW. Certificate of Suitability No. CS/703/S.

Top Entry Deep Junction Boxes	
Cat. No.	Description
240TF4/20	Deep Junction Box with 4 x 20mm top entries.
240TF2/20	Deep Junction Box with 2 x 20mm top entries.



Top Entry Deep Junction Boxes - Dimensional Details			
Cat. No.	Diameter (O.D.)	Height (H)	Fascia Height
240TF Series	100mm	73mm	52mm

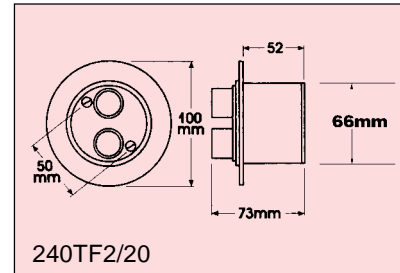

Please refer to pages 34 - 36 for accessories for Round Junction Boxes.

253 Series Slimline Junction Boxes

These Slimline Junction Boxes provide maximum space for drawing in or joining cables and are narrow enough to be installed behind fluorescent lights and similar equipment. They are available in 20mm and 25mm two way only, in deep and shallow versions.

Standard colour is Grey (GY) with Orange (EO) also available at extra cost.

253 Series Slimline Junction Boxes				
Catalogue Number	Overall Width	Dimensions Length	Depth	Conduit Entries
253/20/2	30mm	150mm	42mm	20mm
253/20/2D	30mm	150mm	72mm	20mm
253/25/2	30mm	150mm	42mm	25mm
253/25/2D	30mm	150mm	72mm	25mm



JUNCTION BOXES 32MM TO 50MM

Junction Boxes 32mm to 50mm

Junction Boxes in this range are based on the same design as the 265 Series Adaptable Enclosures, and so ensure ample room for drawing in and terminating the expected larger cables. They are available 1 through 4 way.

Standard colour is Grey (GY) with Orange (EO) also available at extra cost.

With 32mm Entries

Cat. No.	Description
252/32/1	1 way entry.
252/32/2	2 way through entries.
252/32/2A	2 way angle entries.
252/32/3	3 way entries.
252/32/4	4 way entries.

With 40mm Entries

Cat. No.	Description
252/40/1	1 way entry.
252/40/2	2 way through entries.
252/40/2A	2 way angle entries.
252/40/3	3 way entries.
252/40/4	4 way entries.
252/40DRB	Square Draw in Junction Box with 1 way entry.

Junction Boxes 32mm to 50mm

Cat. No.	Length (L)	Width (W)	Height (H)	Screw Centres (C&D)
252/32	77mm	77mm	54mm	63.5mm
252/40	77mm	77mm	54mm	63.5mm
252/50	108mm	108mm	76mm	89mm

A particular feature of this range is the 252/40DRB. This product has been especially designed to facilitate termination of underground service conduits. Features include an open rear section of the box to allow easy installation of cable in the cavity, pre-drilled fixing holes, and a pre-drilled weep hole to prevent any condensation being carried into the wall.

Certificate of Suitability
No CS/187/S.

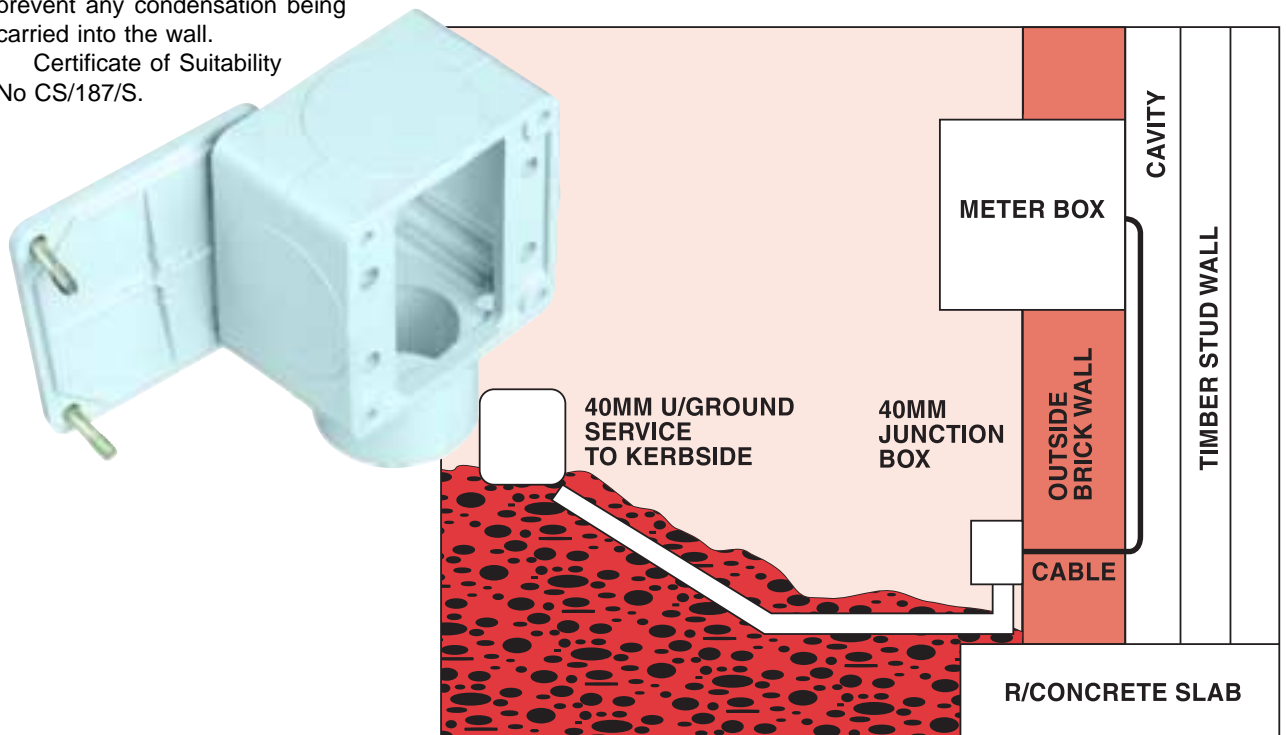
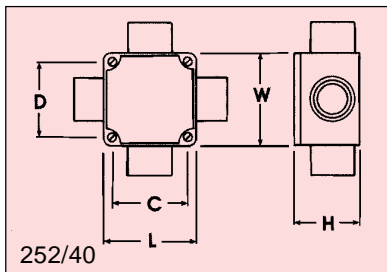

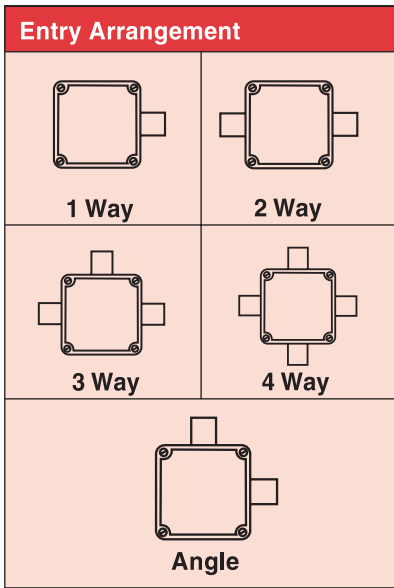

With 50mm Entries	
Cat. No.	Description
252/50/1	1 way entry.
252/50/2	2 way through entries.
252/50/2A	2 way angle entries.
252/50/3	3 way entries.
252/50/4	4 way entries.

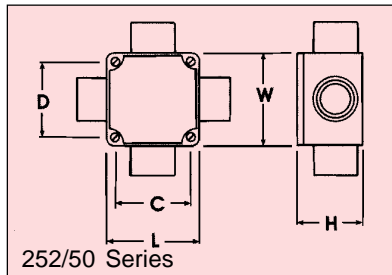

JUNCTION BOXES 63MM

Junction Boxes in this range are based on the same design as the 265 Series Adaptable Enclosures, and so ensure ample room for drawing in and terminating the expected larger cables. They are available 1 through 4 way.

Standard colour is Orange (EO).

With 63mm Entries	
Cat. No.	Description
252/63/1	1 way entry.
252/63/2	2 way through entries.
252/63/2A	2 way angle entries.
252/63/3	3 way entries.
252/63/4	4 way entries.

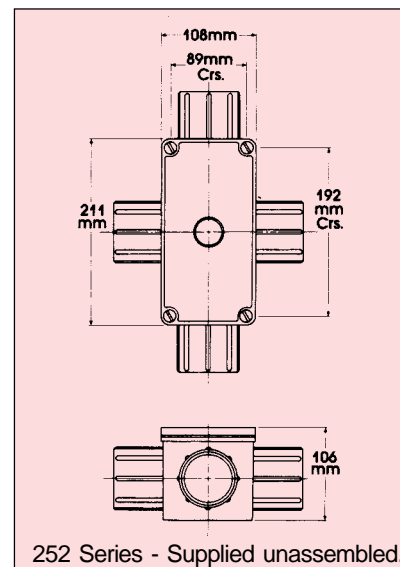

**ACCESSORIES FOR
ROUND JUNCTION
BOXES**

T240AR Adaptable Ring

Adaptable Ring for round tangential junction boxes. Allows Cat. Nos. 31VR and WSR226 Switches to be mounted perpendicularly.

Fixing screw threads - $\frac{3}{16}$ " BSW.
Standard colour - Grey, with Orange (EO) available at extra cost.

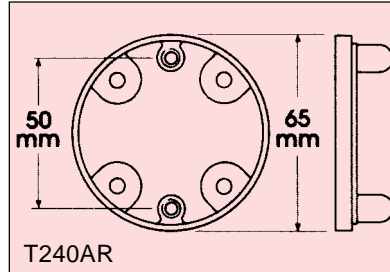

T240/4H/20D Divider - For Segregated Services

Divider for segregated services in Clipsal T240/4H/20 and T240/4H/25 Junction Boxes.



240 Spare Lids

Replacement Lids are available for 240 Series Junction Boxes.

Standard colour is Grey (GY) with Orange (EO) also available at extra cost.

240 Spare Lids

Cat. No.	Outside Diameter (O.D.)	Thickness (T)	Centres (Cr.)
240L	65mm	6mm	50mm

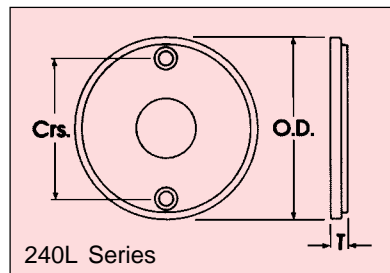

240H Junction Box Lid with Hook

A useful accessory when mounting light fittings on jack chain. The 240H provides a suspension point for the chain, and enables the supply flex to exit the junction box adjacent to it, allowing it to run neatly down the chain to the fitting.

Standard colour is Grey (GY), with Orange (EO) also available at extra cost.

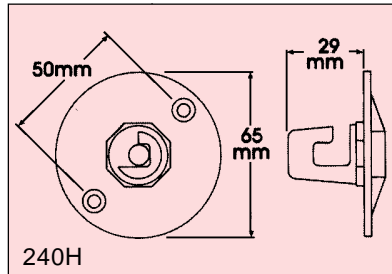

240BL Series Back Entry Lid

This accessory has a conduit spigot attached to a standard box lid to allow cabling to exit via 16mm, 20mm or 25mm conduit.

Standard colour is Grey (GY), with Orange (EO) also available at extra cost.

240BL Series Back Entry Lids	
Cat. No.	Description
240/16BL	16mm Back Entry Lid
240/20BL	20mm Back Entry Lid.
240/25BL	25mm Back Entry Lid.

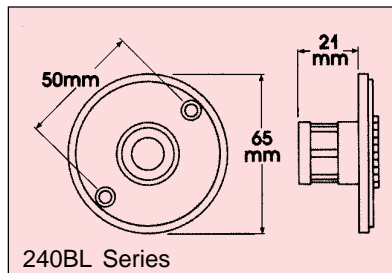

240CF Series Cover Flanges

Clipsal offers two cover flanges to provide a tidier finish on strip finish concrete ceilings.

240CF Series Cover Flanges	
Cat. No.	Description
240CF	Cover Flange for round junction boxes. Tidies junction box installation in poured concrete. Can also be used to mount smoke detectors. Standard colour - Grey.
240CFJ	Cover Flange for round junction boxes. Standard colour - White Electric.

240CF Series Cover Flanges - Dimensional Details			
Cat. No.	Outside Diameter (O.D.)	Thickness (T)	Centres (Crs.)
240CF	85mm	4mm	50mm
240CFJ	100mm	4.5mm	50mm

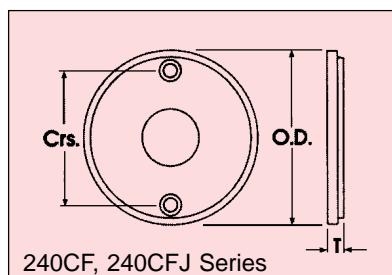

Disposable Covers

Disposable Covers are an ideal way of securing conduit boxes to formwork. They hold the conduit box in place during the concrete pour and allow easy identification and retrieval afterwards. The **240TL** has lugs to allow for fixing by clouts or similar, and the **240TLL** has the lugs removed to allow for alternative fixing. Standard colour is Orange (EO).

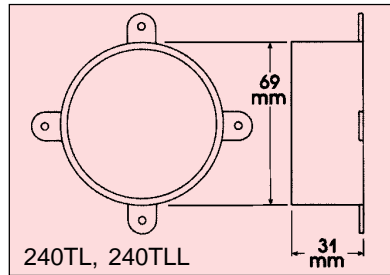

Clip Adaptor

The Conduit Box Clip Adaptor has been designed to locate conduit boxes in metal formwork such as the Spandek system. The Adaptor locates in a 63mm diameter hole drilled in the formwork, holding the box firm during the pour. Available only in Transparent (TR).

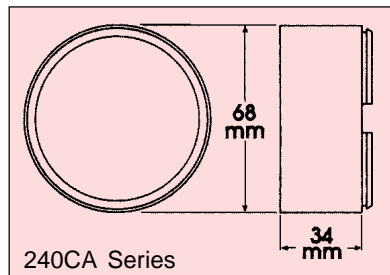

249 Series Extension Rings

Extension Rings fit all 240 Series Junction Boxes and are designed to provide extra space for additional terminations or bring forward the fixing points to allow easier mounting of accessories. Standard colour is Grey (GY), with Orange (EO) also available at extra cost.

249 Series Extension Rings			
Catalogue Number	Outside Diameter	Height (H)	Centres (Crs.)
249/12	65mm	12mm	50mm
249/25	65mm	25mm	50mm

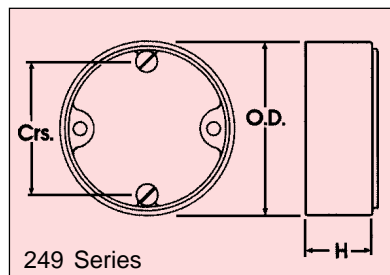

FIXING ACCESSORIES

Clipsal offers a range of fixing accessories for conduit products: metal full saddles (plated and stainless steel)

- metal half saddles
- with and without nails fitted
- full moulded saddles
- spacers
- moulded clips for direct mounting or use with a mounting channel.

Full Saddles - Metal

A full range of full metal saddles is manufactured in plated finishes and a more limited range in stainless steel.

Plating finish options include black zinc, standard zinc plate, and hot dip galvanised.

Half Saddles - Metal

A comprehensive range of half saddles is also available to provide sure fixing and quicker installation. 16mm, 20mm and 25mm sizes are available with larger diameter mounting holes.

Metal Saddles								
Cat. Number	Size	Finish	Gauge	Hole Diameter	Centres	Length	Width	Height
170GM	12.7mm	Zinc Plate	.7mm	5mm	28mm	40mm	13mm	14mm
170M	12.7mm	Black Zinc	.7mm	5mm	28mm	40mm	13mm	14mm
171GM	16mm	Zinc Plate	.7mm	5mm	32mm	45mm	13mm	18mm
171M	16mm	Black Zinc	.7mm	5mm	32mm	45mm	13mm	18mm
172GM	20mm	Zinc Plate	.7mm	5mm	39mm	50mm	16mm	23mm
172M	20mm	Black Zinc	.7mm	5mm	39mm	50mm	16mm	23mm
173GM	25mm	Zinc Plate	.9mm	5mm	48mm	62mm	19mm	28mm
173M	25mm	Black Zinc	.9mm	5mm	48mm	62mm	19mm	28mm
174GM	32mm	Zinc Plate	1.2mm	6mm	63mm	79mm	25mm	35mm
174M	32mm	Black Zinc	1.2mm	6mm	63mm	79mm	25mm	35mm
175GM	40mm	Zinc Plate	1.2mm	6mm	71mm	87mm	25mm	44mm
175M	40mm	Black Zinc	1.2mm	6mm	71mm	87mm	25mm	44mm
176GM	50mm	Zinc Plate	1.2mm	6mm	92mm	108mm	25mm	53mm
176M	50mm	Black Zinc	1.2mm	6mm	92mm	108mm	25mm	53mm
178/63	63mm	Zinc Plate	1.6mm	7mm	107mm	130mm	39mm	66mm
178/80PP	80mm	Zinc Plate	1.6mm	9mm	136mm	166mm	40mm	92mm
178/100PP	100mm	Zinc Plate	1.6mm	9mm	160mm	190mm	40mm	118mm

Stainless Steel Saddles								
Cat. Number	Size	Gauge	Max. Slot Width	Hole Diameter	Centres	Length	Width	Height
172SS	20mm	.9mm	135mm	5mm	39mm	50mm	20mm	24mm
173SS	25mm	.9mm	135mm	5mm	48mm	62mm	20mm	28mm
174SS	32mm	.9mm	135mm	5mm	63mm	79mm	25mm	35mm
175SS	40mm	1.2mm	135mm	5mm	71mm	87mm	25mm	44mm
176SS	50mm	1.2mm	135mm	5mm	92mm	108mm	25mm	55mm

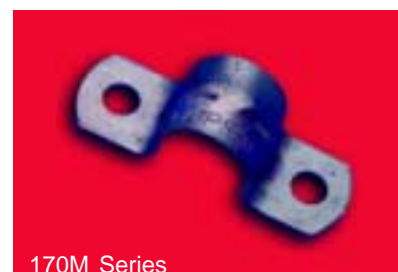
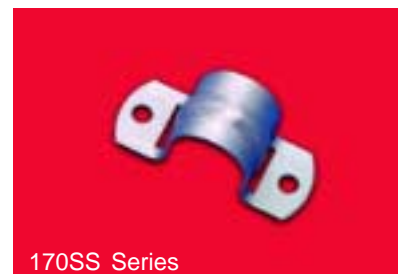
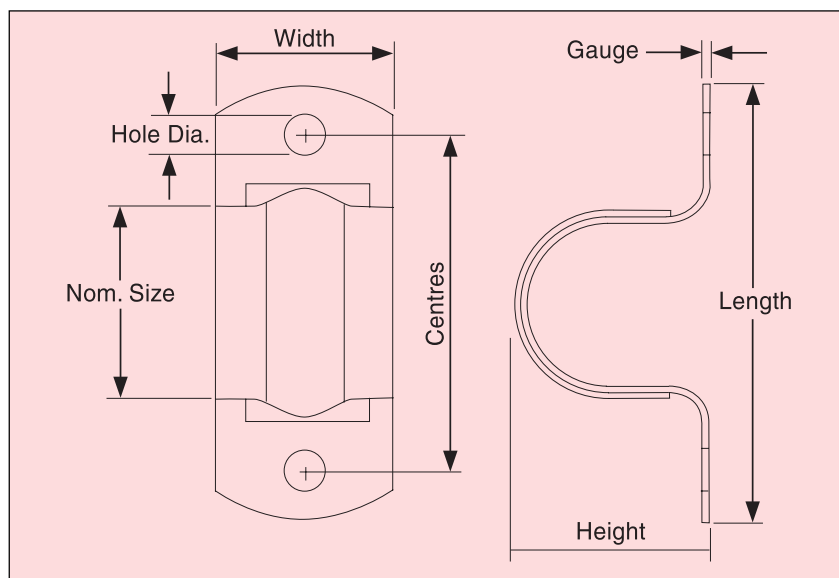

Zinc Plated Half Saddles							
Cat. Number	Size	Finish	Gauge	Hole Diameter	Length	Width	Height
180/12	12.7mm	Zinc Plate	.7mm	5mm	36mm	16mm	15mm
180/16	16mm	Zinc Plate	1.4mm	5mm	46mm	19mm	18mm
180/20	20mm	Zinc Plate	1.4mm	5mm	50mm	19mm	22mm
180/32	32mm	Zinc Plate	1.2mm	7mm	67mm	24mm	33mm
180/40	40mm	Zinc Plate	1.2mm	7mm	74mm	32mm	41mm
180/50	50mm	Zinc Plate	1.6mm	7mm	85mm	39mm	54mm
180A16	16mm	Zinc Plate	1.4mm	6.5mm	46mm	19mm	18mm
180A20	20mm	Zinc Plate	1.4mm	6.5mm	50mm	19mm	22mm
180A25	25mm	Zinc Plate	1.2mm	6.5mm	60mm	25mm	66mm

Zinc Plated Half Saddles with Fixing Nails							
Cat. Number	Size	Finish	Gauge	Nail Size	Length	Width	Height
180N16	16mm	Zinc Plate	1.4mm	25 x 2.8mm	46mm	19mm	18mm
180N20	20mm	Zinc Plate	1.4mm	25 x 2.8mm	50mm	19mm	22mm
180N25	25mm	Zinc Plate	1.2mm	25 x 2.8mm	57.3mm	26mm	26mm

Half Saddles with Nails

A limited range of Half Saddles is also available with hardened masonry nails.



180 Series



180N Series

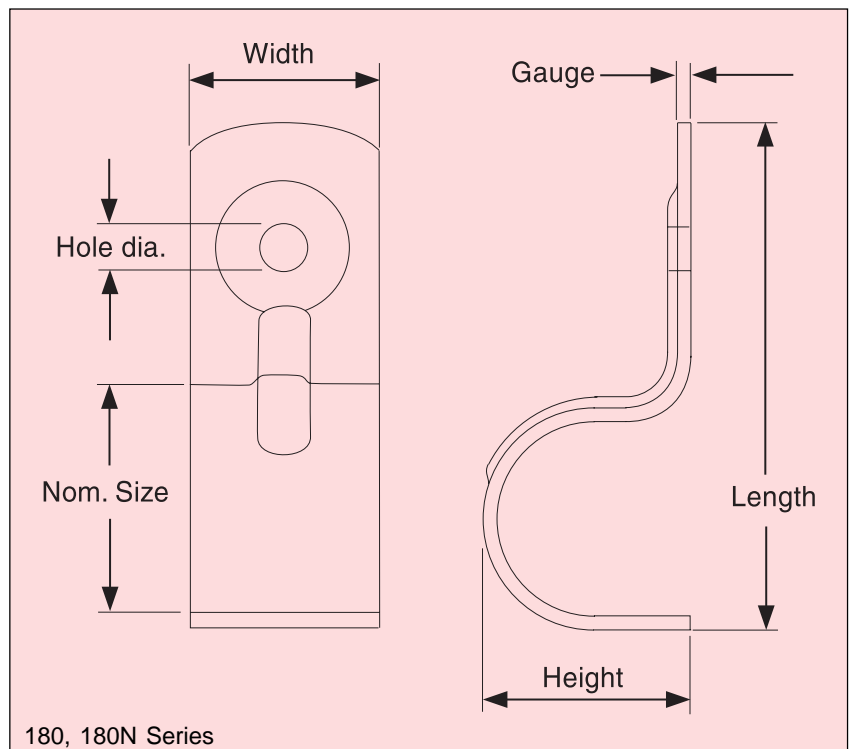

Full Saddles - Moulded

Where neatness and corrosion resistance are imperative, moulded saddles are often the best solution. The 261 Series is tough and UV resistant, and colour matched to the Clipsal conduit product range.

Sizes 16mm through 50mm are Grey (GY) as standard, with Orange (EO) available at extra cost.

The 261/63 is only available in Orange (EO).

Moulded Full Saddles					
Cat. No.	Saddles Diameter	Length (L)	Width (W)	Overall Height	Mounting Centres
261/16	16mm	46mm	15mm	18mm	32mm
261/20	20mm	57mm	16mm	23mm	40mm
261/25	25mm	63mm	20mm	29mm	48mm
261/32	32mm	82mm	22mm	35mm	60mm
261/40	40mm	84mm	24mm	45mm	65mm
261/50	50mm	105mm	27mm	56mm	78mm
*261/63	63mm	120mm	33mm	69mm	91mm

*Standard colour - Orange.



261 Series

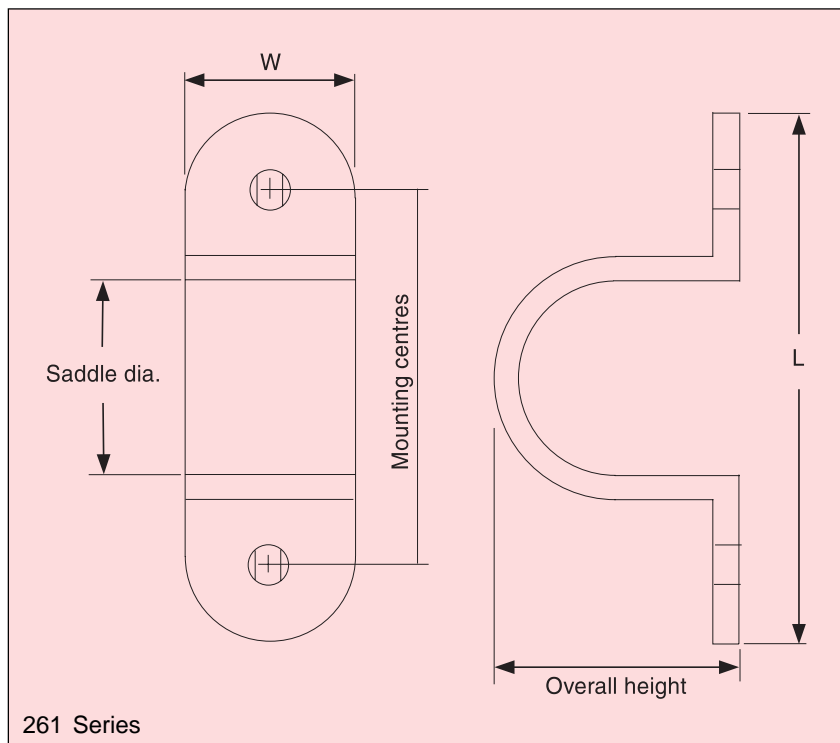

261 Series

Saddle Spacers

Saddles Spacers set a conduit run off the wall 8mm to allow easier cleaning and repainting and to facilitate entry into equipment. They are available in sizes 16mm through 25mm.

Standard colour is Grey (GY), with Orange (EO) also available at extra cost.

Saddle Spacers						
Catalogue Number	Size	Length (L)	Width (W)	Centres (Crs.)	Standoff (T)	Height (H)
261S16	16mm	55mm	21mm	32mm	8mm	14mm
261S20	20mm	61mm	22mm	40mm	8mm	14mm
261S25	25mm	74mm	26mm	48mm	8mm	14mm

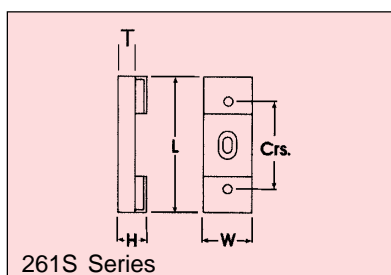

261S Series



261S Series

Saddle Extension Spacers

Extension Spacers allow the stand off provided by the spacers to be extended a further 18mm. They are only available in 20mm and 25mm sizes.

Standard colour is Grey (GY), with Orange (EO) available at extra cost.

Saddle Extension Spacers

Cat. No.	To Suit Cat. No.	Length (L)	Width (W)	Height (H)
261E20	261S20	61mm	22mm	18mm
261E25	261S25	74mm	26mm	18mm

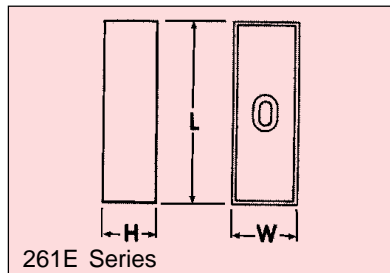

280 Series Conduit Clips

280 Series Conduit Clips are a clip in type conduit mount that can be mounted direct onto a wall or other surface, or slid into a 280MC Mounting Channel. They are available in sizes 16mm through to 50mm, and provide a standoff of between 9mm and 13mm.

Standard colour is Grey (GY), with Orange (EO) available at extra cost.

280 Series Conduit Clips

Cat. No.	Conduit Accommodated	Standoff (S)	Length (L)	Height (H)	Width (W)
280/16	16mm	9mm	22mm	23mm	12mm
280/20	20mm	11mm	27mm	29mm	12mm
280/25	25mm	13mm	34mm	36mm	12mm
280/32	32mm	9mm	41mm	38mm	12mm
280/40	40mm	12mm	49mm	46mm	12mm
280/50	50mm	13mm	62mm	54mm	12mm

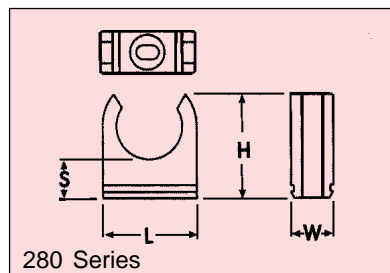

280 Series Mounting Channel

The 280 Series Mounting System is a fast and economical way of mounting a series of parallel conduits. Simply fix the mounting channel at the required spacing over the conduit route. The clips slide into the channel, and the conduits slide into place. The channels can be mounted adjacent and interlocked.

Standard colour is Grey (GY), with Orange (EO) available at extra cost.

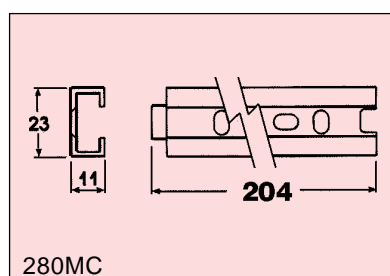

265 SERIES ADAPTABLE BOXES

The 265 Series is a range of IP56 rated insulated boxes suitable for numerous junctions and terminations. Each box is supplied with a 3mm sealing gasket. The 265/7D is also available with a transparent lid.

Standard colour is Grey (GY), with Orange (EO) available at extra cost.

265 Series Adaptable Boxes

Catalogue Number	Length (L)	Width (W)	Height (H)	Screw Centres (C)	Screw Centres (D)
265/1	77mm	77mm	54mm	63.5mm	63.5mm
265/3	108mm	108mm	76mm	89mm	89mm
265/4	163mm	108mm	81mm	143.7mm	89mm
265/5	211mm	108mm	81mm	96mm	89mm
265/7	300mm	200mm	152mm	144.5mm	189mm
265/7D	300mm	200mm	200mm	144.5mm	189mm

Nominal Dimensions.

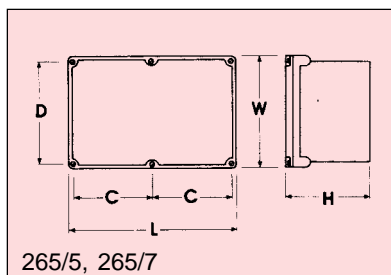
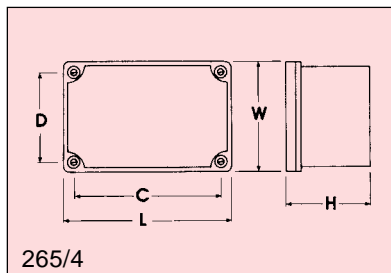
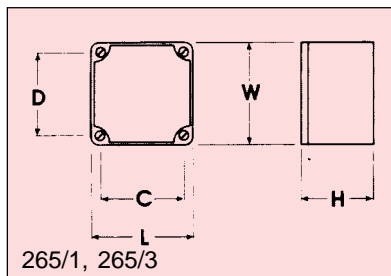

265 Series Sealing Gaskets

Replacement Gaskets are available as a spare part. To order, insert GT in the relevant box's catalogue number, eg. The replacement gasket for a 265/1 is a 265GT1.

265 Series Spacer Nut

The 265/7N is a 25mm Spacer Nut used for fixing a panel on an adaptable box for mounting components. The nut is fitted with a 3/16 inch BSW thread and glues to the box with conduit jointing cement.

Standard colour is Grey.

265 Series Spacer Nut

Cat. No.	Description
265/7N	PVC Spacer Nut to fix panels to bottom of adaptable boxes for attachment of components. Fix to box with rigid PVC cement (Cat. No. 240U). Fitted with $\frac{3}{16}$ " BSW thread. Overall length - 25mm. Dimensions across flats - 25mm. Dimensions across corners - 28mm. Standard colour - Grey.

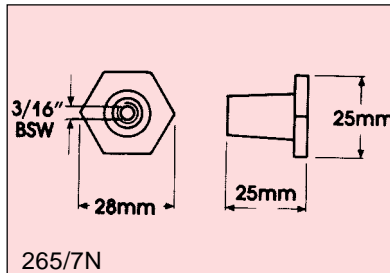

760 Series Adaptable Enclosures

The 760 Series is a range of enclosures for mounting equipment such as timers, relays and contactors. They are fitted with a clear, high clearance lid, and an insulated gear tray.

760 Series Adaptable Enclosures

Cat. No.	Length (L)	Width (W)	Height (H)	C	D
763	108mm	108mm	139mm	89mm	89mm
764	163mm	108mm	142mm	143.7mm	89mm
765	211mm	108mm	139mm	96mm	89mm

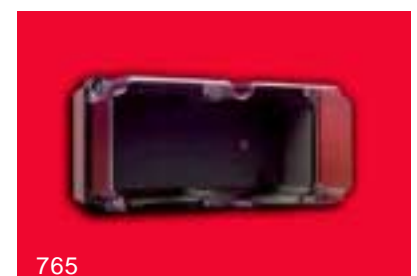
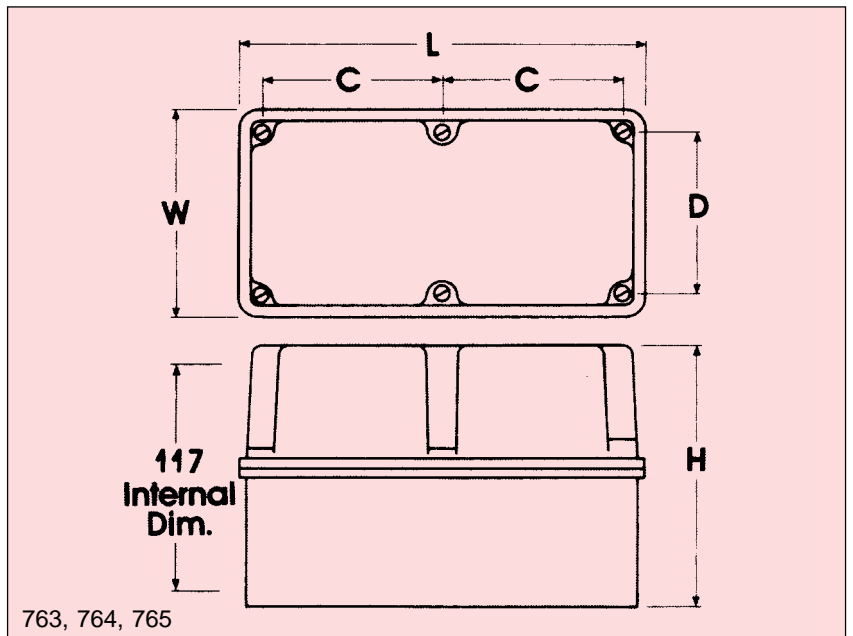

FLEXIBLE CONDUIT TERMINATORS

Clipsal offers the most comprehensive range of accessories for terminating flexible conduit into enclosures. All terminators are supplied with a lock ring and clamp band.

Standard colour is Black.

Straight Type

The 269 straight Type Terminators are available in sizes from 16mm to 50mm. In all cases the thread size is nominally the same size as the flexible conduit spigot. The 268M has a 20mm thread but accepts 16mm flexible conduit.

Flexible Conduit Terminators - Straight Type			
Cat. No.	Male Thread	Plain Male End	Length (L)
268M	20mm	16mm	49mm
269/16	16mm	16mm	43mm
269/20	20mm	20mm	51mm
269/25	25mm	25mm	55mm
269/32	32mm	32mm	55mm
269/40	40mm	40mm	66mm
269/50	50mm	50mm	75mm

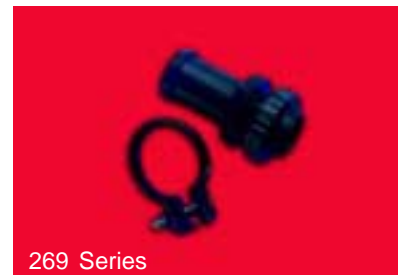
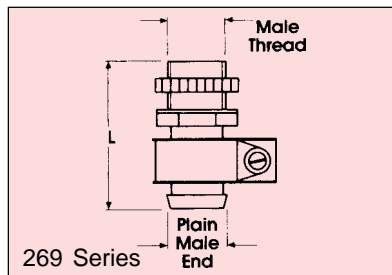

Angled Type

The 269A Angled Type Terminators are available in sizes from 16mm to 40mm. In all cases the thread size is nominally the same size as the flexible conduit spigot. The 268AM has a 20mm thread but accepts 16mm flexible conduit.

Flexible Conduit Terminators - Angled Type			
Cat. No.	Male Thread	Plain Male End	Length (L)
268AM	20mm	16mm	77mm
269A16	16mm	16mm	75mm
269A20	20mm	20mm	80mm
269A25	25mm	25mm	95mm
269A32	32mm	32mm	106mm
269A40	40mm	40mm	124mm

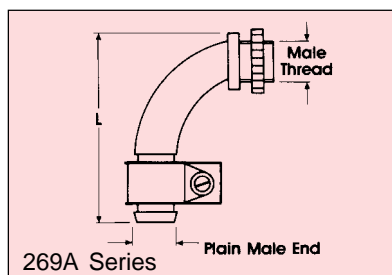

Two Piece Angled Type

The two piece 90° design of the 268AA and the 269AA simplifies cable insertion and allows a sharper right angle.

(Not suitable for exterior use.)

Flexible Conduit Terminators - Two Piece Angled Type			
Cat. No.	Male Thread	Plain Male End	Length (L)
268AA	20mm	16mm	53mm
269AA20	20mm	20mm	55mm
269AA25	25mm	25mm	66mm

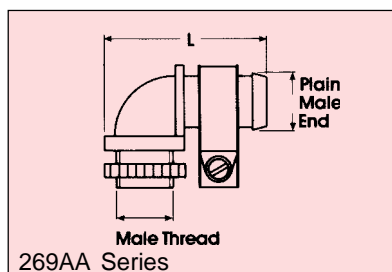

Flexible Conduit Clamp Bands

The Terminator Clamp Bands are also available as individual products.

Flexible Conduit Clamp Bands

Cat. No.	Description
267/16	Clamp Band for 16mm flexible conduit.
267/20	Clamp Band for 20mm flexible conduit.
267/25	Clamp Band for 25mm flexible conduit.
267/32	Clamp Band for 32mm flexible conduit.
267/40	Clamp Band for 40mm flexible conduit.
267/50	Clamp Band for 50mm flexible conduit.

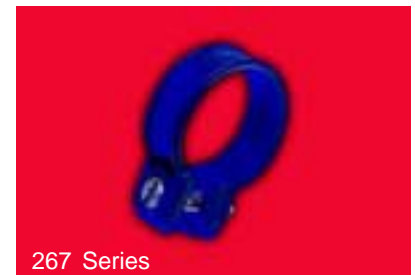

267 Series

Flexible Cover Flange

The 269CF Flexible Cover Flange is designed to fit over 16, 20 and 25mm flexible conduit. Internal flexible centre accommodates from 10mm (min.) OD to 30mm (max.) OD pipes. Mounting holes at 60mm centres on back of flange.

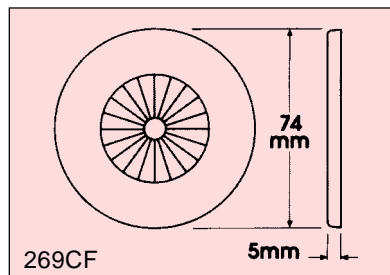

269CF

TELECOMMUNICATIONS FITTINGS

Telecommunications Fittings conform to the same specifications as standard conduit fittings, are White (WE) in colour, and are UV stabilised in line with the requirements of AS/NZS 2053.

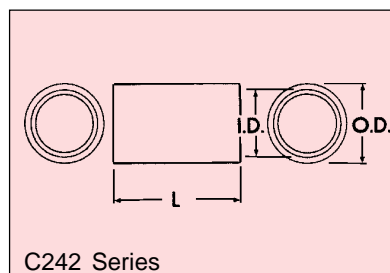

C242 Series

Couplings

Couplings allow joining of two lengths of conduit of the same size.

Standard colour is Grey (GY), except for larger sizes which come as standard in Orange (EO). Orange also available in other sizes at extra cost.

Couplings

Cat. No.	Size	Inside Diameter (I.D.)	Outside Diameter (O.D.)	Length (L)
C242/20	20mm	20mm	25mm	42mm
C242/25	25mm	25mm	30mm	42mm
C242/32	32mm	32mm	37mm	52mm
C242P80	80mm	89mm	98mm	172mm
C242P100	100mm	114.5mm	127mm	228mm

90° Inspection Elbows

The 244 Series is a range of 90 degree Inspection Elbows from 16mm through to 63mm. The design allows the elbow to fit into corners neatly and the inspection cover removes to allow easy wiring and rewiring.

Standard colour is Grey (GY) for sizes up to 50mm with Orange (EO) also available at extra cost. The 244/63 is fabricated from an adaptable box and adaptors, and is standard in Orange (EO). A limited range of Inspection Elbows is also available for Communication Conduit and Security Conduit.

90° Inspection Elbows				
Cat. No.	Size (I.D.)	Overall Length (A)	Overall Length (B)	Height (H)
C244/20	20mm	59mm	59mm	28mm
C244/25	25mm	66mm	66mm	35mm
C244/32	32mm	80mm	80mm	41mm

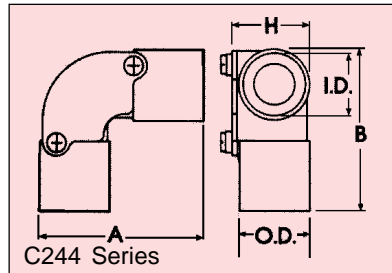

90° Solid Elbows

The 245 Series is a range of 90 degree Solid Elbows from 16mm through to 25mm. The design allows the elbow to fit into corners neatly.

Standard colour is Grey (GY), with Orange (EO) also available at extra cost. An 80mm elbow is also available, standard colour Orange (EO).

A limited range of Solid Elbows is available for Communication Conduit and Security Conduit.

90° Solid Elbows			
Cat. No.	Size (I.D.)	Overall Length (A)	Radius (R)
C245/20	20mm	54mm	22mm
C245/25	25mm	66mm	28mm

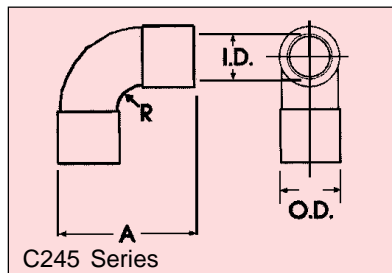

Inspection Tees

The 246 Series is a range of Inspection Tees from 16mm through to 63mm. The screw fixed inspection cover removes to allow easy wiring and rewiring. The 246C20 is a clip-on lid version. The lid is removed by inserting a screwdriver in the tab slots and levering.

Standard colour is Grey (GY) for sizes up to 50mm, with Orange (EO) also available at extra cost.

The 246/63 is fabricated from an adaptable box and adaptors, and is standard in Orange (EO). A limited range of Inspection Elbows is also available for Communication Conduit and Security Conduit.

Inspection Tees				
Cat. No.	Size (I.D.)	Tee Off Length (A)	In Line Length (B)	Height (incl. lid) (H)
C246/20	20mm	55mm	92mm	29mm
C246/25	25mm	69mm	108mm	37mm
C246/32	32mm	82mm	127mm	44mm

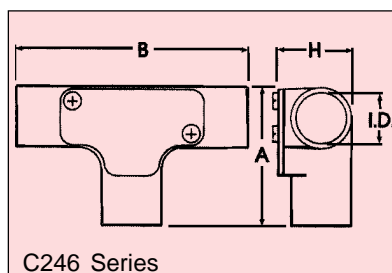

90° Bends

The range of Standard Bends is from 16mm through to 63mm. The 247C20 is a clip-on lid version. The lid is removed by inserting a screwdriver in the tab slots and levering.

Standard colour is Grey (GY) for sizes up to 50mm, with Orange (EO) also available at extra cost. The 246/63 is standard in Orange (EO). A limited range of Standard Bends is also available for Communication Conduit and Security Conduit.

90° Bends

Cat. No.	Size (I.D.)	Overall Length (A)	Radius (R)
C247/20	20mm	83mm	47mm
C247/25	25mm	106mm	64mm

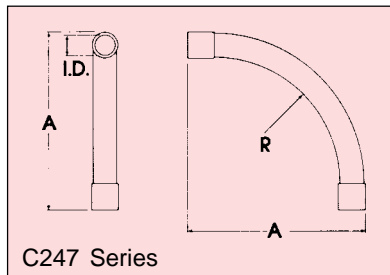

45° Large Sweep Bends

Available in a range of sizes from 20mm to 150mm.

Standard colour Orange (EO).

45° Large Sweep Bends

Cat. No.	Size	Inside Diameter(I.D.)	Overall Length (A)	Overall Height (B)	Radius (R)
C247PH80	80mm	89mm	330mm	610mm	580mm
C247P100	100mm	114.5mm	410mm	750mm	715mm

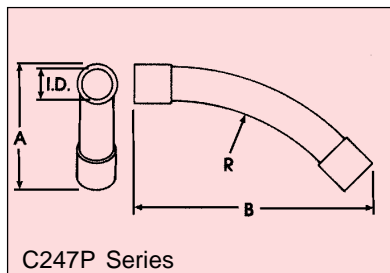

90° Large Sweep Bends

Available in a range of sizes from 20mm to 150mm sizes.

Standard colour Orange (EO). A limited range is also available in White for Communication Conduit.

90° Large Sweep Bends

Cat. No.	Size	Inside Diameter (I.D.)	Overall Length (A)	Radius (R)
C247L20	20mm	20mm	185mm	150mm
C247L25	25mm	25mm	192mm	150mm
C247L32	32mm	32mm	350mm	312mm
C247L50	50mm	50mm	360mm	320mm
C247P80	80mm	89mm	660mm	550mm
C247P100	100mm	114.5mm	900mm	600mm

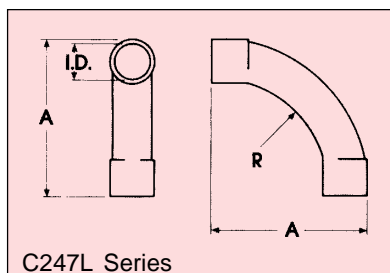

SECURITY FITTINGS

Security Fittings conform to the same specifications as standard conduit fittings and are Transparent (TR) in colour.

Note: They are not UV stabilised and exposure to direct sunlight will result in loss of transparent properties.

Couplings

Plain Couplings allow joining of two lengths of conduit of the same size.

Standard colour is Grey (GY), except for larger sizes which come as standard in Orange (EO). Orange also available in other sizes at extra cost.

Security Fittings			
Cat. No.	Size (I.D.)	Outside Diameter (O.D.)	Length (L)
SC242/16	16mm	20mm	38mm
SC242/20	20mm	25mm	42mm
SC242/25	25mm	30mm	42mm
SC242/32	32mm	37mm	52mm
SC242/40	40mm	45mm	58mm
SC242/50	50mm	57mm	80mm

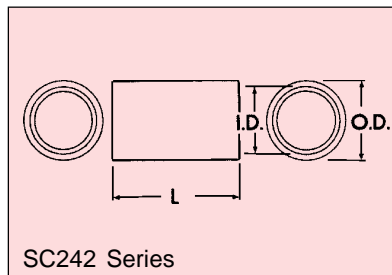

90° Solid Elbows

The 245 Series is a range of 90 degree Solid Elbows from 16mm through to 25mm. The design allows the elbow to fit into corners neatly.

Standard colour is Grey (GY), with Orange (EO) also available at extra cost. An 80mm elbow is also available, standard colour Orange (EO).

A limited range of Solid Elbows is available for Communication Conduit.

Please refer to page 45.

90° Solid Elbows				
Cat. No.	Size	Outside Diameter (O.D.)	Overall Length (A)	Radius (R)
SC245/16	16mm	20mm	50mm	18mm
SC245/20	20mm	25mm	54mm	22mm
SC245/25	25mm	30mm	66mm	28mm

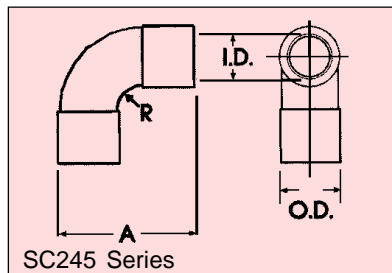

Inspection Tees

The 246 Series is a range of Inspection Tees from 16mm through to 63mm. The screw fixed inspection cover removes to allow easy wiring and rewiring. The 246C20 is a clip-on lid version. The lid is removed by inserting a screwdriver in the tab slots and levering.

Standard colour is Grey (GY) for sizes up to 50mm, with Orange (EO) also available at extra cost.

The 246/63 is fabricated from an adaptable box and adaptors, and standard in Orange (EO). A limited range of Inspection Elbows is also available for Communication Conduit and Security Conduit.

Inspection Tees				
Cat. No.	Size	Tee Off Length (A)	In Line Length (B)	Height (H)
SC246/16	16mm	55mm	92mm	29mm
SC246/20	20mm	55mm	92mm	29mm
SC246/25	25mm	69mm	108mm	37mm
SC246/32	32mm	82mm	127mm	44mm

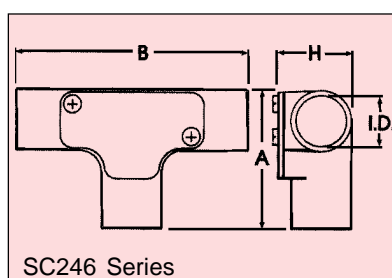

90° Bends

The range of Standard Bends is from 16mm through to 63mm. The 247C20 is a clip-on lid version. The lid is removed by inserting a screwdriver in the tab slots and levering.

Standard colour is Grey (GY) for sizes up to 50mm, with Orange (EO) also available at extra cost. The 246/63 is standard in Orange (EO). A limited range of Standard Bends is also available for Communication Conduit and Security Conduit.

90° Bends			
Cat. No.	Size (I.D.)	Length (A)	Radius (R)
SC247/16	16mm	68mm	41mm
SC247/20	20mm	83mm	47mm
SC247/25	25mm	106mm	64mm
SC247/32	32mm	134mm	83mm
SC247/40	40mm	155mm	100mm
SC247/50	50mm	205mm	120mm

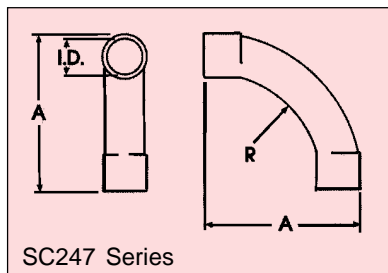

Plain to Screwed Adaptors

Plain to Screwed Adaptors allow rigid conduit to be terminated into an enclosure and secured with a lock ring or lock nut. They are available for conduit sizes 16mm through to 100mm. Lock rings are supplied with 80mm and 100mm sizes.

Standard colour is Grey (GY), except for larger sizes which come as standard in Orange (EO). Orange also available in other sizes at extra cost.

Plain to Screwed Adaptors				
Cat. No.	Male Thread Diameter	Inside Diameter (I.D.)	Outside Diameter (O.D.)	Length (L)
SC263/16	16mm	16mm	21mm	33mm
SC263/20	20mm	20mm	25mm	36mm
SC263/25	25mm	25mm	32mm	42mm
SC263/32	32mm	32mm	38mm	46mm
SC263/40	40mm	40mm	47mm	50mm
SC263/50	50mm	50mm	59mm	59mm

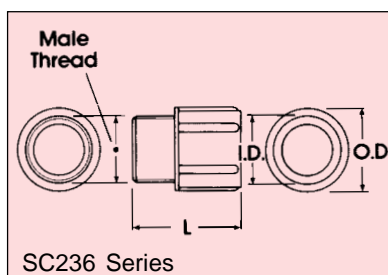

Round Junction Box Lid

A useful accessory when mounting light fittings on jack chain. The 240H provides a suspension point for the chain, and enables the supply flex to exit the junction box adjacent to it, allowing it to run neatly down the chain to the fitting.

Standard colour is Grey (GY), with Orange (EO) also available at extra cost.



NON METALLIC CORRUGATED CONDUIT

Non Metallic Corrugated Conduit is manufactured to comply with relevant sections of AS/NZ 2053 and comes in Medium Duty and Heavy Duty grades. Medium Duty products are UV stabilised.

Operative temperature range is -15°C to +65°C.

One of the main benefits of Non Metallic Corrugated Conduit is that it can be tightly coiled without effort or damage to wall sections, nor will there be any reduction in cross sectional area. This significantly reduces installation time in difficult situations and the number of fittings required.

The minimum bending radius is 1.5 times the nominal diameter.

Non Metallic Corrugated Conduit is designed for use with existing rigid fittings and solvent cement. A range of dedicated glands and adaptors is also available.

The Medium Duty and Medium Duty Sheathed products are ideal for use in poured concrete or surface installations around difficult areas such as beams. Heavy Duty Corrugated is approved for use in Category A underground applications. (AS/NZ2S 3000)

Glands are recommended where joints may be disassembled for maintenance purposes.

If Clipsal Heavy Duty Corrugated Conduit is to be used in installations that allow it to be exposed to direct sunlight, the conduit should be painted with a light coloured water based acrylic paint.

White corrugated conduit is UV stabilised and manufactured to the requirements of AS2053 and ACATS008.

Medium Duty - Electrical			
Catalogue Number	Outside Diameter	Inside Diameter	Coil Length
9016CM	16mm	10.7mm	50m
9020CM	20mm	14.1mm	50m
9020CM10	20mm	14.1mm	10m
9020CM20	20mm	14.1mm	20m
9025CM	25mm	18.3mm	50m
9025CM10	25mm	18.3mm	10m
9025CM20	25mm	18.3mm	20m
9032CM	32mm	24.3mm	25m
9032CM10	32mm	24.3mm	10m
9040CM	40mm	31.2mm	25m
9040CM10	40mm	31.2mm	10m
9050CM	50mm	39.6mm	25m
9050CM10	50mm	39.6mm	10m

Colour - Grey

Medium Duty - Communications			
Cat. No.	Outside Diameter	Inside Diameter	Coil Length
C9020CM	20mm	14.1mm	50m
C9025CM	25mm	18.3mm	50m



Medium Duty with Draw Wire Electrical

Colour - Grey (GY)

Medium Duty with Draw Wire Electrical			
Catalogue Number	Outside Diameter	Inside Diameter	Coil Length
9016CMD	16mm	10.7mm	50m
9020CMD	20mm	14.1mm	50m
9020CMD20	20mm	14.1mm	20m
9025CMD	25mm	18.3mm	50m
9025CMD20	25mm	18.3mm	20m
9032CMD	32mm	24.3mm	25m
9040CMD	40mm	31.2mm	25m

Medium Duty with Draw Wire - Communication

Colour - White (W)

Medium Duty with Draw Wire - Communication			
Catalogue Number	Outside Diameter	Inside Diameter	Coil Length
C9020CMD	20mm	14.1mm	50m
C9025CMD	25mm	18.3mm	50m

Medium Duty Sheathed - Electrical

Colour - Grey (GY).

Medium Duty Sheathed - Electrical			
Catalogue Number	Outside Diameter	Inside Diameter	Coil Length
9020CMS	20mm	14.1mm	50m
9020CMS10	20mm	14.1mm	10m
9020CMS20	20mm	14.1mm	20m
9025CMS	25mm	18.3mm	50m
9025CMS10	25mm	18.3mm	10m
9025CMS20	25mm	18.3mm	20m
9032CMS	32mm	24.3mm	25m

Medium Duty Sheathed with Draw Wire Electrical

Colour - Grey (GY).

Medium Duty Sheathed with Draw Wire Electrical			
Catalogue Number	Outside Diameter	Inside Diameter	Coil Length
9020CMSD	20mm	14.1mm	50m
9020CMSD20	20mm	14.1mm	20m
9025CMSD	25mm	18.3mm	50m
9025CMSD20	25mm	18.3mm	20m



Heavy Duty with Draw Wire

Colour - Orange (EO). Supplied complete with draw wire.

Heavy Duty with Draw Wire			
Catalogue Number	Outside Diameter	Inside Diameter	Coil Length
9020CHD	20mm	14.1mm	50m
9020CHD10	20mm	14.1mm	10m
9020CHD20	20mm	14.1mm	20m
9025CHD	25mm	18.3mm	50m
9025CHD10	25mm	18.3mm	10m
9025CHD20	25mm	18.3mm	20m
9032CHD	32mm	24.3mm	25m
9032CHD10	32mm	24.3mm	10m
9040CHD	40mm	32.9mm	25m



9032CHD

GLANDS FOR CORRUGATED CONDUIT

The 279AC Series is designed for use with corrugated conduit.

These glands allow corrugated conduit to be connected directly to equipment and machinery, making maintenance and upgrading simple.

Angled Glands	
Cat. No.	Description
279AC16	16mm 90°Angled. Accepts 16mm corrugated conduit. IP54 rating.
279AC20	20mm 90°Angled. Accepts 20mm corrugated conduit. IP54 rating.
279AC25	25mm 90°Angled. Accepts 25mm corrugated conduit. IP54 rating.
279AC32	32mm 90°Angled. Accepts 32mm corrugated conduit. IP54 rating.



263/20C



279AC Series

263/20C Clip Adaptor

Adapts 20mm OD corrugated conduit to a 20mm screwed entry.

263/20C Clip Adaptor	
Cat. No.	Description
263/20C	20mm Clip Adaptor.

279B Series Bulkhead Glands

The 279B Series is ideal for terminating corrugated conduit to matching switchboard terminating boxes and bulkheads.

The large bore flange allows plenty of room for cable access. The inbuilt seal ensures IP54 rating when mounted on a flat surface.

Glands with Bulkhead Flange

Cat. No.	Description
279B25	Accepts 25mm corrugated conduit. IP54 rating.
279B32	Accepts 32mm corrugated conduit. IP54 rating.
279B40	Accepts 40mm corrugated conduit. IP54 rating.
279B50	Accepts 50mm corrugated conduit. IP54 rating.

Bulkhead Glands - Dimensional Details

Cat. No.	D	L	B	M	N	d
279B25	37mm	75mm	45mm	37mm	30mm	4.2mm
279B32	45mm	90mm	56mm	46mm	37mm	5.2mm
279B40	56mm	110mm	70mm	58mm	45mm	6.2mm
279B50	68mm	129mm	84mm	72mm	55mm	6.2mm

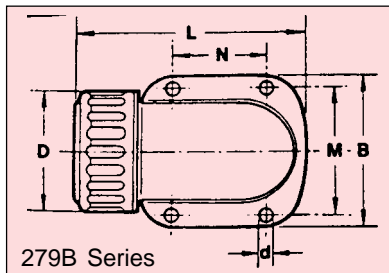

The 279C Series is designed for use with corrugated conduit.

These glands allow corrugated conduit to be connected directly to equipment and machinery, making maintenance and upgrading simple.

Straight Glands - Dimensional Details

Catalogue Number	Male Thread	Length (L)	Across Flats	Across Centres
279C16	16mm	30mm	24mm	26mm
279C20	20mm	35mm	27mm	30mm
279C25	25mm	39mm	35mm	40mm
279C32	32mm	41mm	46mm	52mm
279C40	40mm	53mm	55mm	60mm
279C50	50mm	57mm	66mm	71mm

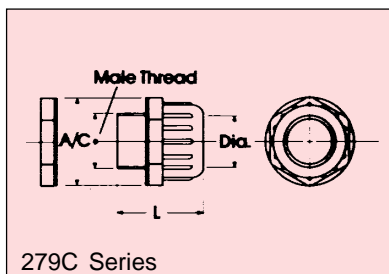

DUCT AND FITTINGS RANGE

Duct systems are the ideal alternative to conduit for surface wiring in domestic, commercial, and industrial environments, particularly when renovations, rewiring, and additions are being undertaken.

Duct systems are easily installed, either fastened with screws or with double sided tape. A broad range of accessories makes installation easy. Butt or mitre joints are also suitable. The range extends from 12mm x 7mm through to 100mm x 100mm. Colour options are White Electric (WE), Grey (GY), and Brown (BR). Not all products are available in all colours.

900 Series Mini Duct

Clipsal Duct is divided into Mini Duct and Maxi Duct. Colours - White Electric (WE), Brown (BR) and Grey (GY). Standard length 4 metres. Some 3.1 metre products also available.

900 Series Mini Duct	
Cat. No.	Description
900/12/7PT	12 x 7mm Pre-Taped Mini Duct With Hinged Lid.
900/16/10	16 x 10mm Mini Duct.
900/16/10PT	16 x 10mm Pre-Taped Mini Duct.
900/16/16	16 x 16mm Mini Duct.
900/16/16PT	16 x 16mm Pre-Taped Mini Duct.
900/19/7	19 x 7mm Bevel Edged Duct.
900/19/7PT	19 x 7mm Pre-Taped Bevel Edged Duct.
900/25/16	25 x 16mm Mini Duct.
900/25/16PT	25 x 16mm Pre-Taped Mini Duct.
900/25/25	25 x 25mm Mini Duct.
900/25/25PT	25 x 25mm Pre-Taped Mini Duct.
900/40/16	40 x 16mm Mini Duct.
900/40/16PT	40 x 16mm Pre-Taped Mini Duct.
900/40/25	40 x 25mm Mini Duct.
900/40/25PT	40 x 25mm Pre-Taped Mini Duct.
900/40/25/2	40 x 25mm Twin Compartment Rectangular Mini Duct.
900/40/25/2PT	40 x 25mm Twin Compartment Rectangular Pre-Taped Mini Duct.
900/60/25	60 x 25mm Mini Duct.
900/60/25PT	60 x 25mm Pre-Taped Mini Duct.
900/60/40	60 x 40mm Mini Duct.
900/60/40PT	60 x 40mm Pre-Taped Mini Duct.

900 Series Mini Duct - 3 Metre Pre-Taped	
Cat. No.	Description
900/12/7PT3	12 x 7mm Pre-Taped Duct with hinged lid. 3.1 metres.
900/16/16PT3	16 x 16mm Pre-Taped Duct. 3.1 metres.
900/25/25PT3	25 x 25 Pre-Taped Duct. 3.1 metres.

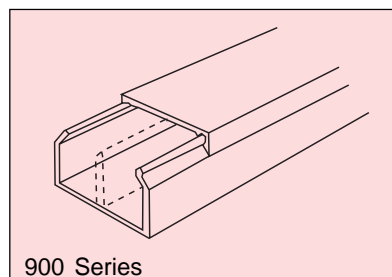

900 Series Maxi Duct

Standard colour Grey (GY).
Some products also available in
White Electric (WE).
Standard length - 4 metres.

900 Series Maxi Duct

Cat. No.	Description
*900/50/50	50 x 50mm Maxi Duct.
*900/50/50PT	50 x 50mm Pre-Taped Maxi Duct.
900/50/75	50 x 75mm Maxi Duct.
900/50/100	50 x 100mm Maxi Duct.
900/75/75	75 x 75mm Maxi Duct.
*900/75/100	75 x 100mm Maxi Duct.
*900/100/100	100 x 100mm Maxi Duct.
900/150/50	150 x 50mm Maxi Duct.
900/150/75	150 x 75mm Maxi Duct.

*Available in White Electric.

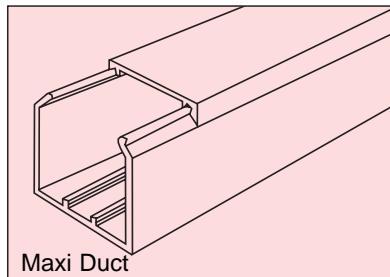

DUCT FITTINGS

A broad range of Clip Fit Fittings are available for the various duct sizes. The range varies between sizes. Not all fittings are available in all colours.

Standard colour Grey (GY).

End Plugs

End Plugs are used to blank off a duct end.

Mini Duct End Plugs

Cat. No.	Description	Length (L)	Width (W)	Height (H)
900/16/16P	Plug for 16 x 16mm duct	13mm	16mm	16mm
900/25/16P	Plug for 25 x 16mm duct	13mm	25mm	16mm
900/40/25P	Plug for 40 x 25mm duct	14mm	40mm	25mm

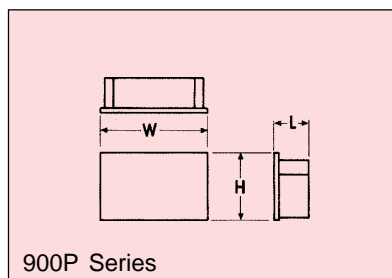

End Plugs

End Plugs are used to blank off a duct end.

Maxi Duct End Plugs

Cat. No.	Description
900/50/50P	50 x 50mm End Plug.
900/50/75P	50 x 75mm End Plug.
900/50/100P	50 x 100mm End Plug.
900/75/75P	75 x 75mm End Plug.
900/75/100P	75 x 100mm End Plug.
900/100/100P	100 x 100mm End Plug.

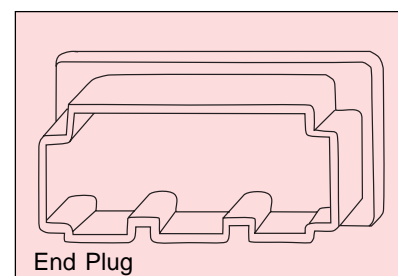
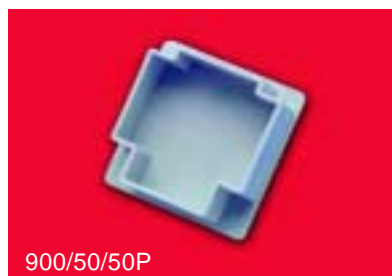

Adaptors

Adaptors allow conversion of various duct sizes to 16mm x 25mm duct and accessories.

Adaptors	
Cat. No.	Description
900/40TA25 900/16A10	Allows 25 x 16mm duct to Tee off a 40 x 25mm duct. Converts 16 x 10mm duct to 25 x 16mm duct and accessories with 25 x 16mm entries.
900/16A16	Converts 16 x 16mm duct to 25 x 16mm duct and accessories with 25 x 16mm entries.
900/25A25	Converts 25 x 25mm duct to 25 x 16mm duct and accessories with 25 x 16mm entries.
900/40A16	Converts 40 x 16mm duct to 25 x 16mm duct and accessories with 25 x 16mm entries.
900/40A25	Converts 40 x 25mm duct to 25 x 16mm duct and accessories with 25 x 16mm entries.

Adaptors - Dimensional Details

Cat. No.	Length (L)	Width (W)	Depth (D)
900/40TA25	60mm	66mm	22.8mm
900/16A10	47.4mm	17.75mm	25.2mm
900/16A16	47.4mm	17.75mm	25.2mm
900/25A25	47.4mm	27mm	29.81mm
900/40A16	42.70mm	40mm	17.3mm
900/40A25	37.80mm	40mm	17.3mm

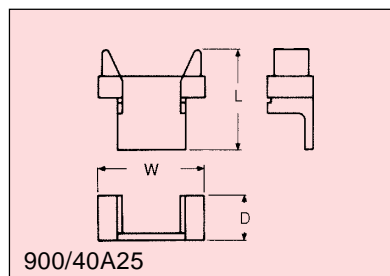

Mini Duct Couplings

Couplings are clip on covers to butt joints in duct.

Mini Duct Couplings

Cat. No.	Description
90/16/16C	Coupling for 16 x 16mm duct.
900/25/16C	Coupling for 25 x 16mm duct.
900/40/25C	Coupling for 40 x 25mm duct.

Mini Duct Couplings - Dimensional Details

Cat. No.	Length (L)	Width (W)	Height (H)
900/16/16C	50mm	20mm	18mm
900/25/16C	50mm	29mm	18mm
900/40/25C	44mm	37mm	21mm

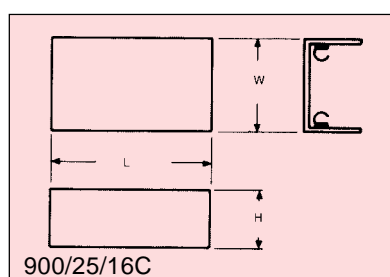

Maxi Duct Couplings

Clip on covers to butt joints in duct. Colour - Grey.

Maxi Duct Couplings	
Cat. No.	Description
900/50C	50mm Coupling.
900/75C	75mm Coupling.
900/100C	100mm Coupling.

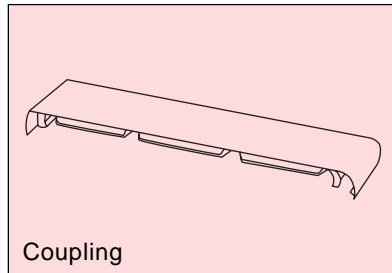

Mini Duct Internal Elbows

Mini Duct Elbows are clip on covers for internal corners.

Mini Duct Internal Elbows	
Cat. No.	Description
900/16/16EI	Internal Elbow for 16 x 16mm duct.
900/25/16EI	Internal Elbow for 25 x 16mm duct.
900/40/25EI	Internal Elbow for 40 x 25mm duct.

Mini Duct Internal Elbows - Dimensional Details			
Cat. No.	Length (L)	Width (W)	Height (H)
900/16/16EI	43mm	20mm	43mm
900/25/16EI	41mm	29mm	41mm
900/40/25EI	57mm	39mm	57mm

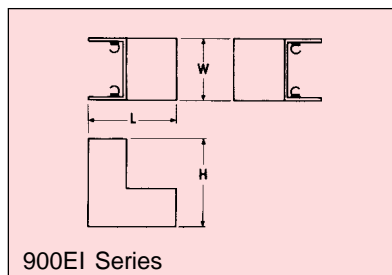

Maxi Duct Internal Elbows

Maxi Duct Elbows are a prefabricated corner piece. Colour - Grey.

Maxi Duct Internal Elbows

Cat. No.	Description
900/50/50EI	50 x 50mm Internal Elbow.
900/50/75EI	50 x 75mm Internal Elbow.
900/50/100EI	50 x 100mm Internal Elbow.
900/75/75EI	75 x 75mm Internal Elbow.
900/75/100EI	75 x 100mm Internal Elbow.
900/100/100EI	100 x 100mm Internal Elbow.

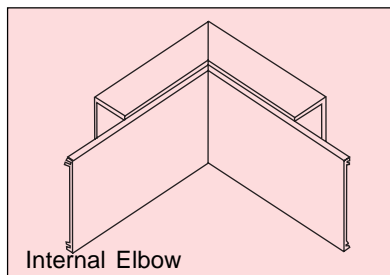

Mini Duct External Elbows

Mini Duct Elbows are clip on covers for internal corners.

Mini Duct External Elbows

Cat. No.	Description
900/16/16EE	External Elbow for 16 x 16mm duct.
900/25/16EE	External Elbow for 25 x 16mm duct.
900/40/25EE	External Elbow for 40 x 25mm duct.

Mini Duct External Elbows - Dimensional Details

Cat. No.	Length (L)	Width (W)	Height (H)
900/16/16EE	43mm	20mm	43mm
900/25/16EE	43mm	29mm	43mm
900/40/25EE	59mm	44mm	59mm

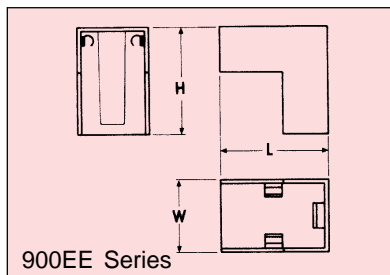

Maxi Duct External Elbows

Maxi Duct Elbows are a prefabricated corner piece. Colour - Grey.

Maxi Duct External Elbows	
Cat. No.	Description
900/50/50EE	50 x 50mm External Elbow.
900/50/75EE	50 x 75mm External Elbow.
900/50/100EE	50 x 100mm External Elbow.
900/75/75EE	75 x 75mm External Elbow.
900/75/100EE	75 x 100mm External Elbow.
900/100/100EE	100 x 100mm External Elbow.

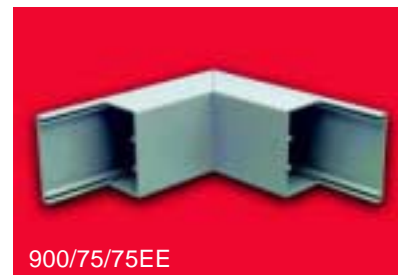
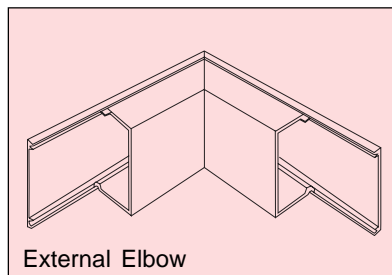

Mini Duct Flat Elbows

Mini Duct Flat Elbows	
Cat. No.	Description
900/16/16E	Flat Elbow for 16 x 16mm duct.
900/25/16E	Flat Elbow for 25 x 16mm duct.
900/40/25E	Flat Elbow for 40 x 25mm duct.

Mini Duct Flat Elbows - Dimensional Details			
Cat. No.	Length (L)	Width (W)	Height (H)
900/16/16E	43mm	18mm	43mm
900/25/16E	52mm	18mm	52mm
900/40/25E	74mm	27mm	74mm

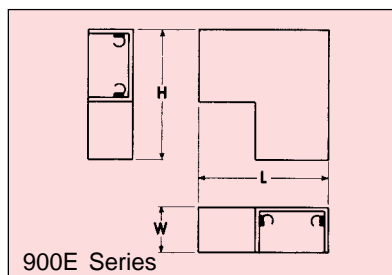

Maxi Duct Flat Elbows

Maxi Duct Elbows are a prefabricated corner piece.
Colour - Grey.

Maxi Duct Flat Elbows

Cat. No.	Description
900/50/50E	50 x 50mm Flat Elbow.
900/50/75E	50 x 75mm Flat Elbow.
900/50/100E	50 x 100mm Flat Elbow.
900/75/75E	75 x 75mm Flat Elbow.
900/75/100E	75 x 100mm Flat Elbow.
900/100/100E	100 x 100mm Flat Elbow.

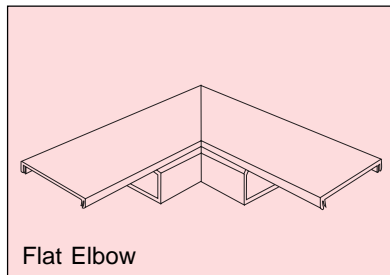

Mini Duct Flat Tees

Mini Duct Tees are clip on covers for internal corners.

Mini Duct Flat Tees

Cat. No.	Description
900/16/16T	Flat Tee for 16 x 16mm duct.
900/25/16T	Flat Tee for 25 x 16mm duct.
900/40/25T	Flat Tee for 40 x 25mm duct.

Mini Duct Flat Tees - Dimensional Details

Cat. No.	Length (L)	Width (W)	Height (H)
900/16/16T	66mm	43mm	18mm
900/25/16T	75mm	52mm	18mm
900/40/25T	104mm	74mm	27mm

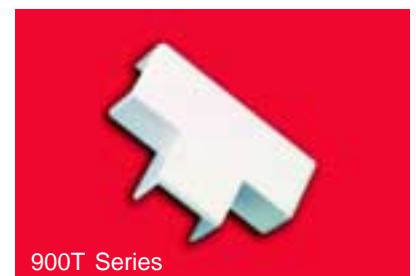
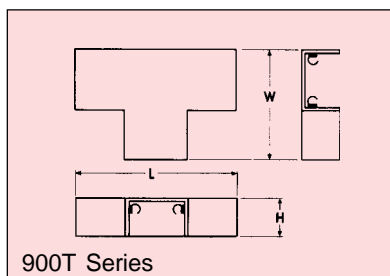

Maxi Duct Tees

Maxi Duct Tees are a prefabricated Tee section.
Colour - Grey.

Maxi Duct Tees

Cat. No.	Description
900/50/50T	50 x 50mm Tee.
900/50/75T	50 x 75mm Tee.
900/50/100T	50 x 100mm Tee.
900/75/75T	75 x 75mm Tee.
900/75/100T	75 x 100mm Tee.
900/100/100T	100 x 100mm Tee.

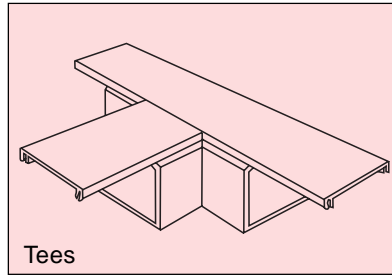

Side Tee

Clip on covers to tee off at right angles with the same size mini duct.

Side Tee	
Cat. No.	Description
900/25/16TS	Side Tee for 25 x 16mm duct.

Side Tee - Dimensional Details			
Cat. No.	Length (L)	Width (W)	Height (H)
900/25/16TS	75mm	40mm	29mm

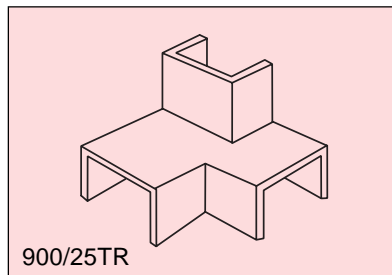

Intersection Tees

Clip on covers to tee off a flat elbow at right angles. Left and right hand versions are available. Only available in some Mini Duct sizes.

Intersection Tees	
Cat. No.	Description
900/25/16TR	Right Tee (Intersection) for 25 x 16mm duct.
900/25/16TL	Left Tee (Intersection) for 25 x 16mm duct.

Intersection Tees - Dimensional Details			
Cat. No.	Length (L)	Width (W)	Height (H)
900/25/16TR	52mm	40mm	52mm
900/25/16TL	52mm	40mm	52mm

Clip In Separators

Clip in dividers to provide segregation in 50mm, 75mm and 100mm maxi duct.

Standard Length - 4 metres.
Colour - White Electric.

Clip in Separators	
Cat. No.	Description
900D50S	Suits 50 x 100mm Maxi Duct.
900D75S	Suits 75 x 100mm Maxi Duct.
900D100S	Suits 100 x 100mm Maxi Duct.



Connector Clip

Connector Clip to join maxi duct sections independent of the lid. Lid must be trimmed to accommodate. Not suitable for 50mm x 50mm. Colour - White Electric.

Connector Clip	
Cat. No.	Description
900CC	Connector Clip to join all sizes of maxi duct (50 x 50mm size excepted).

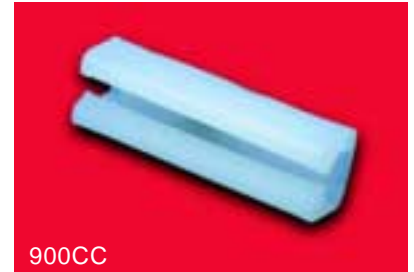
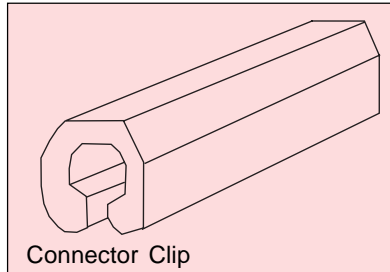

Clip In Cable Retainers

Clip to retain cable in duct prior to installation of the lid. Colour - White Electric.

Clip in Cable Retainers	
Cat. No.	Description
900C50	50 x 100mm Maxi Duct.
900C75	75 x 100mm Maxi Duct.
900C100	100 x 100mm Maxi Duct.

MOUNTING ACCESSORIES

Architrave Mounting Block

The 900MMB is a Miniature Surface Mounting Block for architrave mounting accessories. Internal depth - 24mm. Features 2 - 25 x 16mm trunking entries - one each end. Supplied with 1 Cat. No. 900MBC Clip-in/push out Cap 2 Cat. No. 9 Insulating Caps and 2 M3.5 x 0.8 x 12mm long pan head screws. Screws thread into brass inserts.

Available in White Electric (WE) and Brown (BR).

Architrave Mounting Block			
Cat. No.	Length (L)	Width (W)	Height (H)
900MMB	76mm	33mm	28mm

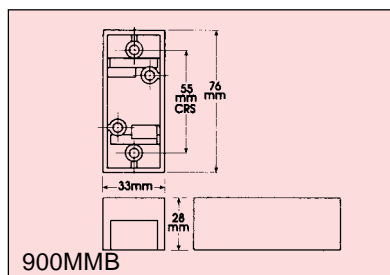

Standard Pattern Mounting Box

The 900SPMB is a standard pattern Surface Mounting Box for single gang accessories. Internal depth - 33mm. Features 4 - 25 x 16mm Trunking Entries, including one each end and side. Supplied with 3 - Cat. No. 900MBC Clip-in/push out caps, 4 - Cat. No. 220/10 Insulating Caps and 2 - M3.5 x 0.8 x 16mm long pan head screws. Screws thread into brass inserts.

Available in White Electric (WE), Brown (BR) and Grey (GY).

Standard Pattern Mounting Box			
Cat. No.	Length (L)	Width (W)	Height (H)
900SPMB	116mm	74mm	38mm

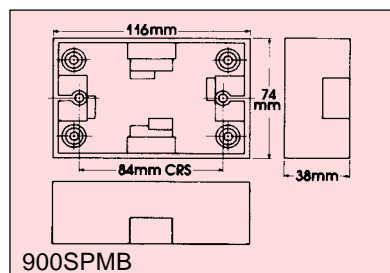

Round Mounting Block

The 900RMB is a Round Surface Mounting Block, for mounting round accessories. Internal depth - 15mm. Features 2 - 25 x 16mm trunking entries. Through entries. Number of mounting positions - 2. Supplied with 1 Cat. No. 900MBC Clip-in/push-out Cap, 2 - Cat. No. 220/10 Insulating Caps, and 2 - 3/16" BSW x 12mm long pan head screws.

Available in White Electric (WE) and Brown (BR).

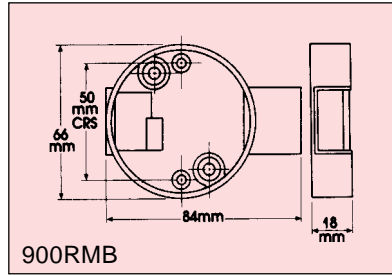

Skirting Mounting Block

The 900SKMB is a single gang Skirting Mounting Block. Accepts 25 x 16mm trunking through 4 of 25 x 16mm cut outs. Supplied with 3 x Cat. No. 900MBC Mounting Block Entry Caps and 20mm mounting screws and screw caps.

Available in White Electric (WE) and Brown (BR).

Skirting Mounting Block				
Cat. No.	Length (L)	Width (W)	Height Centres	Mounting
900SKMB	10mm	49mm	38mm	78mm



Mounting Block/Box Entry Cap

Spare Entry Blanking Cap for mounting accessories.

Mounting Block/Box Entry Cap	
Cat. No.	Description
900MBC	Mounting Block Entry Cap suitable for 25 x 16mm trunking entries. Available in White Electric and Brown.

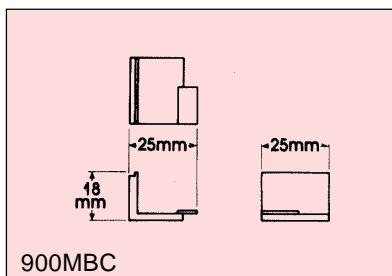

Standard Pattern Mounting Block

The 900SPBP is a single gang standard pattern Mounting Block. Accepts 25 x 16mm and 16 x 16mm trunking through 12 of 16 x 16mm and 8 of 25 x 16mm combination head screws for mounting.

Available in White Electric (WE), Brown (BR) and Grey (GY).

Standard Pattern Mounting Block				
Cat. No.	Length (L)	Width (W)	Height Centres	Mounting
900SPBP	120mm	76mm	20mm	84mm



Double Sided Adhesive Tape

Double Sided Tape provides a quick and convenient method of mounting duct. Surfaces must be clean and dry, and free of dirt, dust, moisture, grease and flaking paint. It must be firmly applied along the full length of the duct to ensure secure fixing. Large sizes may require two rows of tape.

Double Sided Adhesive Tape

Cat. No.	Description
900AT12	12mm wide Double Sided Impact Adhesive Tape. 50 metre roll.
900AT18	18mm wide Double Sided Impact Adhesive Tape. 50 metre roll.
900AT24	24mm wide Double Sided Impact Adhesive Tape. 50 metre roll.

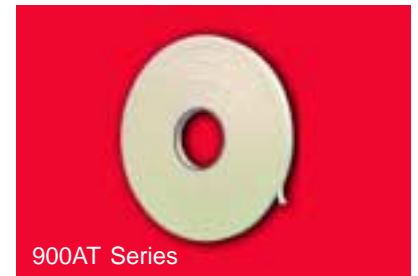

POLYMERIC CABLE COVER

The Polymeric Cable Cover is an economical and convenient way to provide the mechanical protection for Category B underground wiring systems as required by AS/NZ S3000. Clipsal's range includes 2 metre slabs in both 150mm and 250mm widths, which are an excellent option for smaller installations, and 25 metre rolls in widths from 150mm to 300mm in both light duty and heavy duty gauges.

Available in Orange (EO) only.

Complies With:

HD Series Cable Covers are manufactured from High Density PolyEthylene and have been tested and found to comply with the requirements of DR94102 and AS1462.3. (DR94102 is a Draft Australian Standard for Cable Cover. This draft has not yet been issued as an approved Standard, but has become a defacto Standard in the electrical industry).

LD Series Cable Covers are manufactured from High Density PolyEthylene and have been tested to the requirements of DR94102 and AS1462.3. LD Series passes the requirements of AS1462.3, but will not necessarily comply with Section 10.2 of DR94102 "Impact

Resistance Test". However, it will comply with all other aspects of DR94102.

Polymeric Cable Cover

Cat. No.	Description
287/150	150mm wide. Length 2 metres - 3mm thick.
287/250	250mm wide. Length 2 metres 3mm thick.
287R150LD	150mm wide, 4mm thick. Length - 25 metres.
287R200LD	200mm wide, 4mm thick. Length - 25 metres.
287R250LD	250mm wide, 4mm thick. Length - 25 metres.
287R300LD	300mm wide, 4mm thick. Length - 25 metres.
287R150HD	150mm wide, 5mm thick. Length - 25 metres.
287R200HD	200mm wide, 5mm thick. Length - 25 metres.
287R250HD	250mm wide, 5mm thick. Length - 25 metres.
287R300HD	300mm wide, 5mm thick. Length - 25 metres.

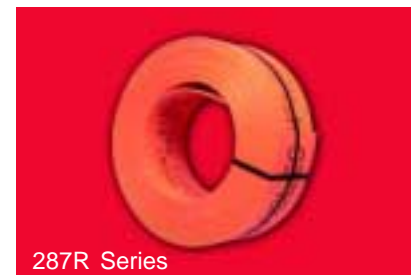

Products of Gerard Industries Pty Ltd

ACN 007 873 529

Head Office

12 Park Terrace, Bowden
 South Australia 5007
 Telephone (08) 8269 0511
 Facsimile (08) 8340 1724
 E-Mail plugin@clipsal.com.au
 Internet clipsal.com

**Offices in all States**

NSW	Sydney	(02) 9794 9200
	Albury	(02) 6041 2377
VIC	Melbourne	(03) 9207 3200
	Country Areas	1800 653 893
QLD	Brisbane	(07) 3244 7444
	Townsville	(07) 4729 3333
SA	Adelaide	(08) 8269 0555
WA	Perth	(08) 9442 4444
TAS	Hobart	(03) 6272 3177
	Launceston	(03) 6331 6951
NT	Darwin	(08) 8947 0278

Area Representatives

NSW	Albury	(02) 6041 2377
	Central Coast	0418 430 361
	Coffs Harbour	0418 653 183
	Dubbo	0418 822 564
	Newcastle	015 298 792
		0418 434 169
		0418 686 040
	South West Sydney	0419 868 353
	Tamworth	0417 714 339
	Wagga Wagga	0418 578 903
	Wollongong	0418 423 581
ACT	Canberra	0419 238 824
	Canberra/Goulburn	0418 164 070
	Canberra/Yass	0419 847 732
VIC	Bendigo	0418 570 213
	Geelong & Sth West	0418 527 233
	Gippsland	0418 512 680
	Western Victoria	0419 380 444
QLD	Cairns	0418 773 254
	Gold Coast	0418 765 459
	Mackay	0418 752 134
	Maryborough	0418 664 338
	Northern Rivers	0418 768 902
	Rockhampton	0418 794 711
	Sunshine Coast	0418 711 786
	Toowoomba	0418 746 311
	Townsville	0418 180 372
WA	Bunbury	0418 931 684
	Kalgoorlie &	
	Eastern Gold Fields	0417 928 981
	Karratha	0418 937 249
SA	Riverland/Mildura/	
	Broken Hill	0418 596 145

International Enquiries**Head Office Export Department**

Telephone +61 8 8269 0587
 Facsimile +61 8 8340 7350
 E-Mail export@clipsal.com.au

New Zealand**Clipsal Industries (NZ) Ltd**

Telephone (09) 576 3403
 Facsimile (09) 576 1015
 E-Mail headoffice@clipsal.co.nz

Customer Service - North Island

Telephone (09) 572 0014
 Free Fax 0800 733 567

Customer Service - South Island

Telephone (03) 379 5368
 Free Fax 0800 250 305

Gerard Industries Pty Ltd reserves the right to change specifications, modify designs and discontinue items without incurring obligation and whilst every effort is made to ensure that descriptions, specifications and other information in this catalogue are correct, no warranty is given in respect thereof and the company shall not be liable for any error therein.

Printed by Custom Press Pty Ltd (08) 8346 7999

1/00 Order No. 892-941