



Industrial Switchgear

Plugs and Sockets



Make the right choice

Don't judge industrial switchgear by its colour

clipsal.com

Life Is 

CLIPSAL
by Schneider Electric



Contents

Introduction	5-11
56 Series Features	6
66 Series Features	8
WilcoROWCO	10
Application Guide	
Product selector	12-13
Product Catalogue	
Neutral	14-73
Combination Switched Socket Outlets	14
Surface Socket Outlets	19
Switches	22
Appliance Inlets	39
Plugs	41
Extension Sockets and Appliance Connectors	45
Special Combinations and Modules	48
Mounting Enclosures (Lids & Back Boxes)	53
Adaptable Enclosures	60
Accessories and Spare Parts	67
Acid	74-109
Combination Switched Socket Outlets	74
Surface Socket Outlets	78
Switches	80
Appliance Inlets	88
Plugs	89
Extension Sockets and Appliance Connectors	92
Special Combinations and Modules	94
Mounting Enclosures (Lids & Back Boxes)	96
Adaptable Enclosures	100
Accessories and Spare Parts	103
Alkaline	110-133
Combination Switched Socket Outlets	110
Surface Socket Outlets	112
Switches	113
Plugs	115
Extension Sockets and Appliance Connectors	119
Mounting Enclosures (Lids & Back Boxes)	123
Adaptable Enclosures	126
Accessories and Spare Parts	127
Heavy Duty	134-147
Combination Switched Socket Outlets	134
Surface Socket Outlets	137
Switches	139
Appliance Inlets	142
Plugs	144
Extension Sockets and Appliance Connectors	145
Special Combinations and Modules	146
Mounting Enclosures (Back Boxes)	148
Adaptable Enclosures	149
Railway Couplers	150
Accessories and Spare Parts	151
Technical Guide	
Chemical Resistance Guide	152-153
Industrial Application Matrix	154-158
International Protection Ratings	159



Introduction

The Power Behind Today's Industry

Designed to satisfy customer needs, precisely engineered and carefully manufactured, Clipsal Industrial Switchgear is as versatile as your requirements. Industrial switchgear, being one of the most important components of industry, must be tough, and perform under many adverse conditions.

Clipsal's Industrial Switchgear range, comprising of 56 Series, 66 Series and Wilco Ranges, satisfies these challenges with the use of durable engineering plastics and cast metal and in most instances have been tested for protection against ingress of water and dust to International Protection Rating IP66. It is testimony to the excellence in both manufacture and performance of Clipsal Industrial Switchgear.

Operation

For safety's sake all of the switches in the Clipsal Industrial Switchgear ranges have been equipped with facilities for double pad-locking. When plugs are removed, the socket flap automatically locks into place, resisting dust or water from entering.

Standards

Pin configurations for plugs, sockets and switched socket outlets comply with AS/NZS3123 and switches with appropriate parts of AS/NZS3947.3 & AS/NZS3133.

Temperature Resistance

The temperature range of the 56 & 66 Series and Wilco products are limited by two aspects;

- 1) the material used in mouldings and castings
- 2) the operating temperature of the internal electrical components.

The material type limits the use of the 56 & 66 Series standard product to -25°C to +75°C. All materials used for the Wilco ranges are tested to operate in extreme temperatures from -20°C to +60°C ambient.

Transparent Plastic Materials

The introduction of transparent materials to the 56 and 66 Series ranges enables the inspection and checking of the components pin/socket configuration and wiring at a glance, while still providing protection against the elements.

Designed to Mix and Match

What suits one industry might not be the best match for another. That's why the 56 Series and WilcoROWCO* ranges were specifically designed to mix and match. There is an extensive choice of modules available, including switches, sockets, and residual current devices. Clipsal mounting enclosures range in size from 1 to 4 for WilcoROWCO and 1 to 16 gang for 56 Series.

This allows assemblies to be customised - from a simple switch station to a large electrical control panel. Accessories can be ordered Less Enclosure (back box) by simply specifying LE after the 56 Series catalogue number or /LE after specific WilcoROWCO catalogue numbers.

*from 10A to 32A

56 Series Features

Switches, sockets, or combination switch sockets features and benefits

1. One- and two-piece cover options; one-piece improves water resistance in wash-down areas and two-piece is ideal for economical changeovers
2. Large switch handle simplifies operation with gloves
3. Contoured profile — reduces potential dirt build-up areas
4. Increased padlocking area — more flexibility when locking off
5. Solid cover, (no pivot bungs or holes) to add strength to flap and resist water/dust entry
6. Patented rigid gasket design provides IP66 even without cover screw caps; gasket won't flex or pinch under cover
7. LED kit option — ideal to monitor phase conditions without the need to remove covers
8. Switch-knob padlock hole locations below horizontal reduces dust entering and seizing switch-knob
9. Knob Bearing improves switch life, endurance, smoothness of actuation and resists switch seizure
10. Clearances between switch cover & knob allow for any dust ingress to come out, resisting switch knob seizure
11. Wide opening hinged flap to assist with plug insertion/removal — without allowing dust or water ingress
12. Permanent laser markings eliminate stickers falling off into food or beverages
13. Co-injected socket gasket — avoids shrinkage in harsh environments

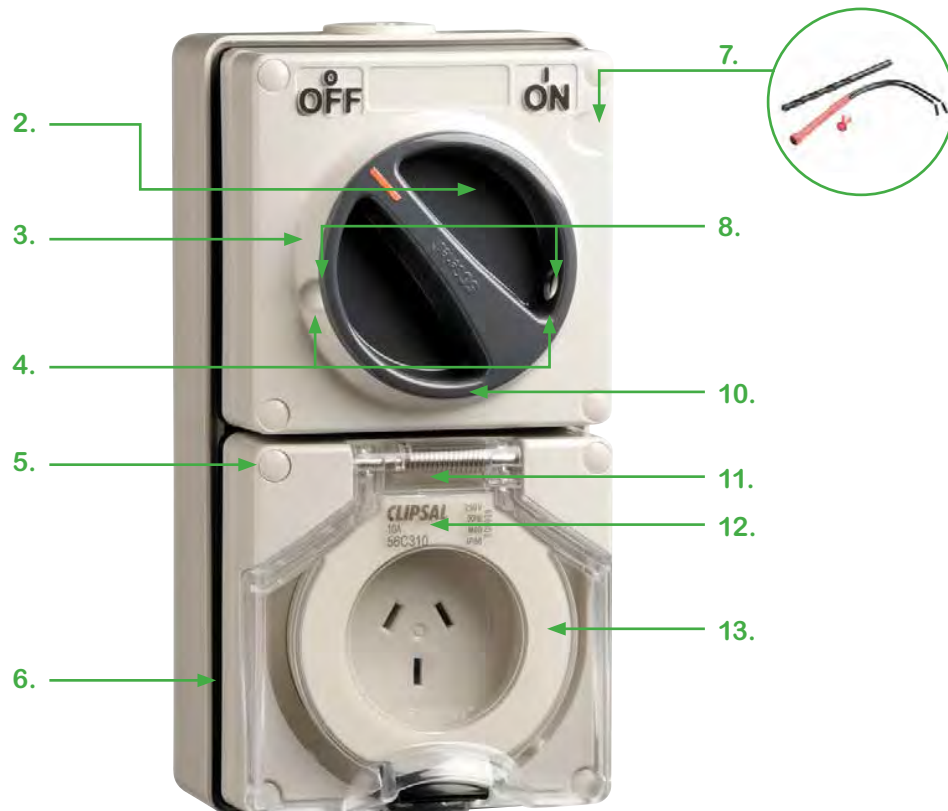

Plugs and plug sockets features and benefits

1. Less parts, more efficiency
2. Separate adaptor available for SWA, corrugated, or hose fittings provides full protection of cabling to end of plug
3. Patented Mactro snap-shut body
 - Fast access — ideal during breakdowns
 - No screws — removes stress points
4. Improved body shape — ergonomic hand placement
5. Unique cable clamp provides simplified sealing around cable, avoiding fiddly onion ring approach
6. Wide lock ring for simple operation whilst wearing gloves
7. Shallow grooves on lock ring and cable clamp reduce potential for dirt being trapped and improves hygiene

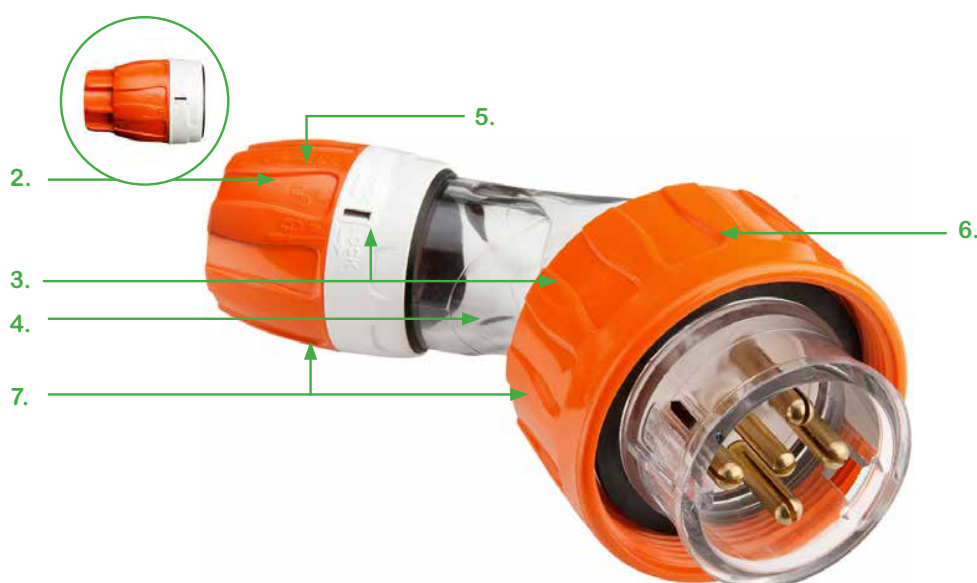

Snap shut bodies

Screw-less assembly using a 'latching' spring allows for speed, simplicity, product strength and improved reliability. The 'latching' spring clip stays down once it is pressed, so it is just a simple 'press and switch'. The spring clip, when shut, does not exert any stress on the housings, resulting in a stronger body and sleeve connection.

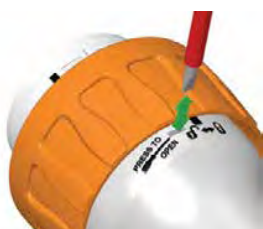

To Open

1. Look for padlock and arrow icons
2. Align grey band to locked position
3. Insert driver and push down firmly
4. Align grey band to unlocked position
5. Twist body left only



To Close

1. Look for padlock and arrow icons
2. Align grey band to unlocked position
3. Insert driver and push down firmly
4. Align grey band to locked position
5. Twist body right only

66 Series Features

Make light work of installations with 66 Series Combination Switched Socket Outlets

Clipsal design, engineering and precision brings you the revolutionary 66 Series of Combination Switched Socket Outlets and Plugs for 50 and 63 amp, 4, 5 or 7 pin heavy-duty appliances, such as welders, pumps, and mobile conveyors.

Until recently 50 and 63 amp socket outlets and plugs were constructed with metal clad housings, which, in many situations, encounter drawbacks with their heavyweight, time consuming installation and susceptibility to corrosion.

66 Series Switched Socket Outlets and Plugs solve these problems and offer many other additional benefits.

Major features of the 66CV Switched Socket Outlets are their robust PVC back box and polyester cover that provide excellent chemical and high impact resistance as well as UV stability, in a neat, compact unit that's quicker and easier to install. 66P Plugs are manufactured from fully moulded, transparent polycarbonate or resistant orange polyester to offer the same degree of strength and resistance to chemicals and UV rays.

For convenience both the switched socket outlets and plugs can be easily used with gloved hands.

An internal interlock is fitted to the outlet to help prevent insertion or withdrawal of the plug (provided the plug is fitted with an interlock facility) while the switch is in the 'on' position.

66CV Series Combination Switched Socket Outlets also incorporate a padlock facility in the 'off' position for added security.



Features

- IP66 protection in accordance with AS 1939 for the Combination Switched Socket Outlet and also when engaged with a plug.
- Separate back box with rear wiring facility for easy installation of large diameter cables.
- 1 x M40 entry (top) and 2 x M32 entries (bottom) to assist cable termination.
- Large switch knob and socket outlet flap for easy operation even with gloved hand.
- Socket outlet flap includes a heavy spring assembly to ensure IP66 integrity.
- Configurations of sockets and keyways in accordance with AS/NZS 3123.
- Stainless steel, combination head, captive cover screws for corrosion resistance and easy installation.
- Switch rated for motor duty, AC23 in accordance with AS/NZS 3947.3.
- Standard colour - Grey. Resistant Orange optional. Double insulated.
- Interior assembly is completely removable to assist with cable entry and termination of the large conductors required for the unit.

Plugs and plug sockets features and benefits

1. Clear pin surround provides quick and reliable location of plug in socket and protection of pins.
2. Wide Lock Ring can be tightened and unscrewed with ease, even with a gloved hand. Provides positive sealing with an inbuilt sponge-type gasket.
3. Sturdy Terminal Housing for durability and years of service.
4. Stainless Steel Combination Head Screws for corrosion resistance and easy installation.
5. Transparent Polycarbonate Body allows instant inspection of connections.
6. Internal Cable Clamp is fast fixing and grips two ways, helping to resist cable twisting.
7. Cable Gland is extremely flexible with positive grip to help ensure dependable sealing.
8. Gland Nut with 50mm threaded cable entry for alternative facility termination.

IP Ratings only apply to cable terminations as per wiring instructions.

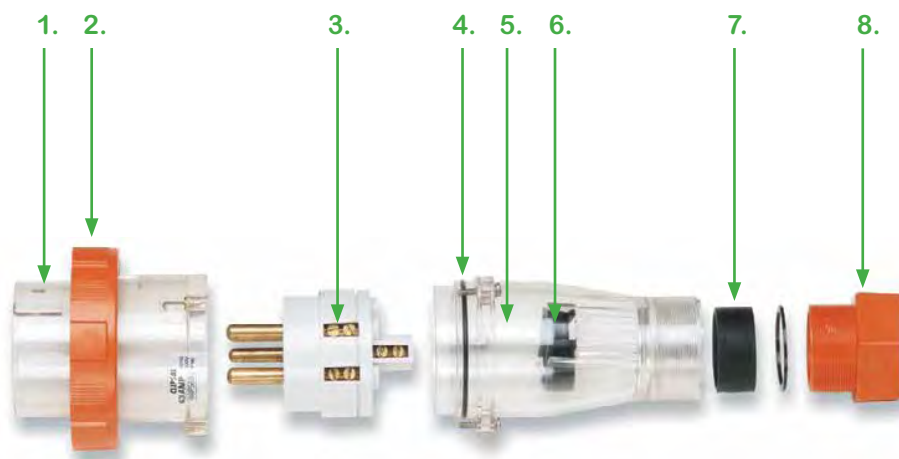

Plug configurations

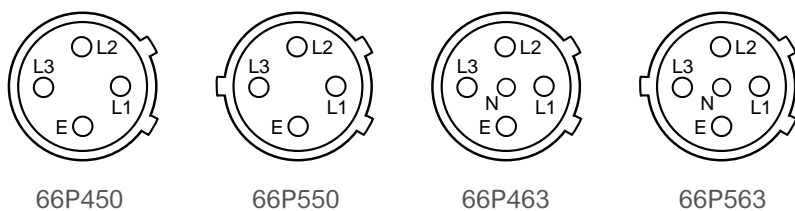

WilcoROWCO

WilcoROWCO Industrial Switchgear is precisely engineered and carefully manufactured to satisfy customer needs and provide versatile solutions to meet any requirements.

Industrial switchgear, being one of the most important components of industry, has to be tough, able to take hard knocks and give dependable performance under many adverse conditions.

WilcoROWCO Metal Clad satisfies these challenges and more with the use of maximum strength die cast aluminium and has been tested for protection against the ingress of water and dust to up to International Protection Rating IP66.



Applications

Heavy Industrial environments both indoors and outdoors where protection from dust, water, UV and impact is needed.

Features

- Heavy duty cast aluminium.
- IP66 rated to IEC60529.
- Internal non-accessible and external accessible-mounting facilities.
- Stainless steel (316 grade) cover mounting screws metric thread stainless steel screws also come standard with the Metal Clad range. They are treated to help resist chemical reaction with the aluminium body, offering superior corrosion resistant properties.
- Can be padlocked off at two locations. The two padlock positions accept 8mm hasp padlocks or scissor lockout tags.

Make the right choice, don't judge industrial switchgear by its colour

No economical plastic material is available to provide maximum impact strength as well as a high degree of chemical resistance. The various products that make up the Clipsal Industrial Switchgear range therefore have been designed specifically in different materials to withstand light, medium and heavy industry applications. In fact, Clipsal 56 Series is the only product of its type that provides UV and IP resistance, along with resistance to general chemicals or neutrals, acids and alkalines. The 56 Series range is complemented by the WilcoROWCO cast metal range that provides 'heavy duty' resistance particularly against impact.

To make the right choice, the following table can be used as a guide when selecting the right material for your application.

				
Range and resistance suitability	56 Series Grey (GY) General industrial uses, Neutral chemicals	56 Series Chemical Resistant Orange (RO) & Chemical Resistant White (RW). Resistance to Acid -based detergents & chemicals	56 Series Chemical Resistant Grey (CG) & Chemical Resistant Dark Grey (WW). Resistance to Alkaline -based chemicals/foaming caustic	WilcoROWCO Metal Clad Cast Aluminium. Toughness for high impact & Heavy Duty environments
Chemical resistance				
Symbol				

The following pages will provide a more detailed guide outlining typical applications for the ranges outlined above. This is to be used in conjunction with the Technical Guide and International Protection charts in the rear of the book.

Application Guide

Make the right choice

the table below is to be used as a guide when establishing which Clipsal Industrial product is best suited for specific environments. It takes into consideration the materials that Clipsal's Industrial range is made from and anticipates what it will be exposed to in various applications. For further information please contact your Clipsal and Schneider Electric representative.

Product Selector				
Application	Environment	Best	Better	Good
Maintenance workshop	Indoors, ambient air temperature, low UV levels, cutting fluids, oils, no or minimal exposure to rain.	Neutral	Acid	Heavy Duty
Tool room or general fabrication workshop	Indoors, ambient air temperature, low UV levels, cutting fluids, oils.	Neutral	Acid	Heavy Duty
Plant rooms	Indoors, 0 °C to 40 °C, low UV levels, possible moisture/condensation, no or limited chemicals or detergent exposure.	Neutral	Acid	Heavy Duty
Pedestrian traffic areas	Indoors or outdoors, ambient air temperature, outdoors may be subjected to high UV levels and rainfall, indoors low UV and moisture, no or minimal chemicals or detergent exposure. May be prone to vandalism.	Neutral	Acid	Heavy Duty
Staff lunchroom	Indoors, 0 °C to 40 °C, low UV levels, some exposure to water, mild detergents or household cleaners. No or minimal exposure to rain. No alkaline cleaners.	Acid	Neutral	Alkaline
Public eating area	Indoors or outdoors, ambient air temperature, outdoors may be subjected to high UV levels and rainfall, indoors low UV and moisture, some exposure to water, mild detergents or household cleaners. No alkaline cleaners.	Heavy Duty	Neutral	Acid
Cool room for perishable storage	Indoors, -10 °C to 15 °C, low UV levels, possible moisture or condensation, no or minimal chemicals or detergent exposure, no or minimal exposure to rain.	Neutral	Acid	Heavy Duty
Warehouse	Indoors, ambient air temperature, low UV levels, no exposure to rain, possible impacts from handling equipment. No or minimal exposure to rain.	Neutral	Acid	Heavy Duty
Assembly plant or fabrication area	Indoors, ambient air temperature, low UV levels, no exposure to rain, possible impacts from handling equipment. No or minimal exposure to rain.	Neutral	Acid	Heavy Duty
Alkali's washdown area (boning rooms, food processing area)	Indoors, 5 °C to 25 °C, low UV levels, foaming alkaline cleaners, 75 °C high pressure cleaners, prone to condensation.	Alkaline		
Detergent washdown (fast food preparation)	Indoors, 5 °C to 25 °C, low UV levels, mild detergents or mild household cleaners, washdown with water, prone to condensation.	Alkaline	Neutral	Acid
Acids or citrus based cleaners (wineries, breweries, coal wash plant)	Indoors or outdoors, ambient temperature of -5 °C to 70 °C, low to high UV levels, acidic chemicals or products, possible exposure to citrus cleaners, washdown with water, no to high exposure to rain or water. No alkaline chemicals or cleaning agents.	Acid		
Bottle or vat sterilising	Indoors, 5 °C to 40 °C, low UV levels, exposure to detergents or sterilising agents, washdown with water, prone to condensation.	Alkaline		
Exposure to cooking Oil (chip friers etc.)	Indoors, 5 °C to 40 °C, low UV levels, exposure to cooking oils, exposure to detergents or alkali cleaners, washdown with water, prone to condensation. No acid based cleaning agents	Alkaline		

Product Selector

Application	Environment	Best	Better	Good
Minerals processing or Furnaces	Indoors, 0 °C to 75 °C, low UV levels, No or minimal exposure to moisture, possible heavy impacts from handling equipment.			
Outdoor storage tanks or ponds or silos	Outdoors, ambient air temperature -15 °C to 75 °C. High UV, possible exposure to acidic chemicals or chlorine, direct exposure to rain. Not DIP or EX.			
Despatch or vehicle loading or transport area	Indoors/outdoors, ambient air temperature, low to high UV levels, no to high exposure to rain, possible impacts from handling equipment.			
Staff or public car park	Indoors or outdoors, ambient air temperature, low to high UV levels, no to high exposure to rain, may be prone to vandalism.			
Toilets/wet areas	Indoors, 5 °C to 40 °C, low UV levels, exposure to detergents or alkali cleaners, washdown with water, prone to condensation. No acid based cleaning agents.			
Office	Indoors, 0 °C to 40 °C , low UV levels, minimal moisture or condensation, no or limited chemicals or detergent exposure.			
Food preparation area or kitchen	Indoors, 5 °C to 25 °C, low UV levels, mild detergents, citrus based or household cleaners, washdown with water, prone to condensation. No alkaline cleaners.			
Rooftop plant platforms	Outdoors, ambient air temperature -15 °C to 75 °C. High UV, direct exposure to rain.			
Bottling plant	Indoors, ambient air temperature, low UV levels, no exposure to rain , possible impacts from handling equipment. No or minimal exposure to rain.			
Swimming pool or growing pond	Indoors/outdoors, ambient air temperature -10 °C to 50 °C, low to high UV levels, no to high exposure to rain, may be prone to vandalism, presence of chlorine.			
Boat washdown	Outdoors, ambient air temperature -15 °C to 75 °C. High UV, direct exposure to rain, exposure to salt water.			
Conveyor belt	Indoors or outdoors, ambient air temperature, low to high UV levels, no to high exposure to rain, may be exposed to impacts. Not DIP or EX.			
Outdoor BBQ's	Outdoors, ambient air temperature -15 °C to 75 °C. High UV, possible exposure to animal fats or cooking oil splash, direct exposure to rain. May be prone to vandalism.			
Outdoor lighting	Outdoors, ambient air temperature -15 °C to 75 °C. High UV, direct exposure to rain. May be prone to vandalism.			



Alkaline

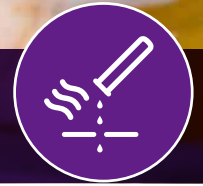

The Alkaline range of Clipsal Industrial products are suited for environments that are Chemically Alkaline, dusty or clean, wet or dry, outdoors (non-UV resistant).

Some typical applications include: abattoirs, boning rooms, seafood processing, poultry, chip fryers and other areas where caustic foaming cleaners or cooking oils are used.

If Clipsal Industrial products are part of the 'alkaline' range, they will easily be identified by a purple circle with Alkaline text and /or by a purple circle with a white test tube symbol as shown below.



AND / OR



The Alkaline range encompasses 56 Series Chemical Grey (CG) & WW products & the 56 Series Resistant Orange (RO) & Electric Orange Plugs (EO). The following section showcases these products in more detail.

Combination Switched Socket Outlets

The 56 Series range of combination switched socket outlets includes two module units and one-piece cover models. All internal phase connections between switches and sockets are factory wired.

The 4 and 5 pin, 10 and 20 A one-piece cover models have integral wiring between the switch and socket outlet. 56 Series Combination Switched Socket Outlets feature a clear flap with a snap catch latch. The current IP66 retention ring plugs can be accommodated. 250 V, 110 V and extra low voltage two module combinations are also available. Versions with key operated switches available to special order.

Less Enclosure versions are indicated with letters LE in the reference.

Internal interlock facility available on three phase, one piece cover combinations, these have the prefix 56CVI.

2 Piece Cover

56 Series

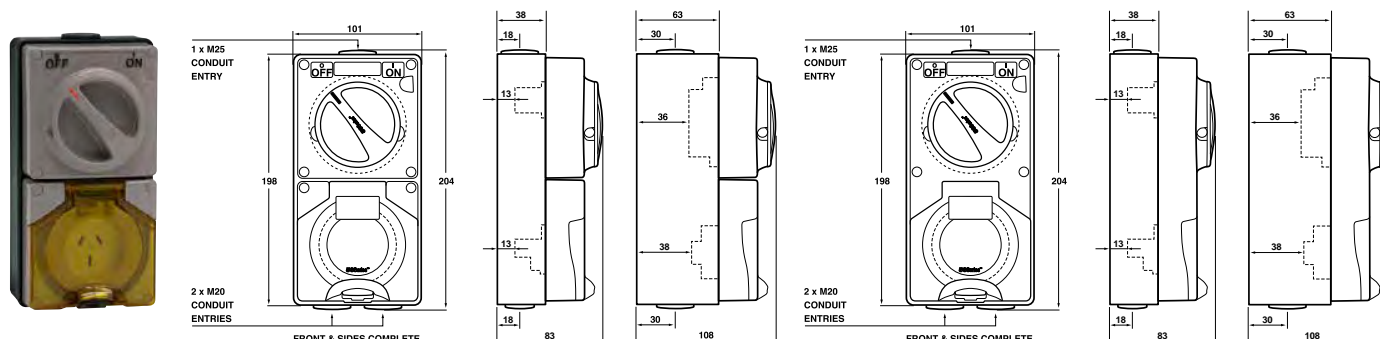

Alkaline - Clipsal 56 Series

Catalogue Number	No. of Switch Poles	I _{the} (Amp)	U _i / U _e (Volt)	I _e (A) Utilisation Category			M Rating	Type of Socket	Cond. Term Size in mm	O/A Dims.			Matching Plug	Socket Config
				AC21A	AC22A	AC23A				Min.Max/Cond.	(H)	(W)		

Chemical Resistant Grey (CG)

56C310-CG	1 Pole	10	250	10	8	8	M80	1P + N + E	[1.5,6]	204	101	83	56P310	A
56C310HD-CG	1 Pole	10	250	10	10	11	M100	1P + N + E	[1.5,16]	204	101	108	56P310	A
56C310L-CG	1 Pole	10	250	10	8	8	M80	1P + N + E	[1.5,6]	204	101	83	56P310SL	C
56C310LE-CG	1 Pole	10	250	10	8	8	M80	1P + N + E	[1.5,6]	204	101	70	56P310	A
56C315-CG	1 Pole	15	250	15	10	8	M80	1P + N + E	[1.5,6]	204	101	83	56P315	B
56C320-CG	1 Pole	20	250	20	20	21	M150	1P + N + E	[2.5,6]	204	101	108	56P320	H
56C332-CG	1 Pole	32	250	32	32	28	M180	1P + N + E	[6,16]	204	101	108	56P332	I
56C410-CG	3 Pole	10	500	10	10	11	M100	3P + E	[1.5,6]	204	101	108	56P410	K
56C416K-CG	3 Pole	16	500	16	16	15	M120	3P + E	[1.5,6]	204	101	108	56P416K	M
56C420-CG	3 Pole	20	500	20	20	21	M150	3P + E	[2.5,6]	204	101	108	56P420	L
56C432-CG	3 Pole	32	500	32	32	28	M180	3P + E	[6,16]	204	101	108	56P432	N
56C510-CG	3 Pole	10	500	10	10	11	M100	3P + N + E	[1.5,6]	204	101	108	56P510	Q
56C520-CG	3 Pole	20	500	20	20	21	M150	3P + N + E	[2.5,6]	204	101	108	56P520	R
56C532-CG	3 Pole	32	500	32	32	28	M180	3P + N + E	[4,16]	204	101	108	56P532	S
56C550-CG	3 Pole	50	500	50	50	35	M250	3P + N + E	[10,16]	204	101	108	56P550	U
56C720-CG	3 Pole	20	500	20	20	21	M150	3P + N + E	[1.5,6/2.5]	204	101	108	56P720	X

Dark Grey (WW)

56C310-WW	1 Pole	10	250	10	8	8	M80	1P + N + E	[1.5,6]	204	101	83	56P310	A
56C315-WW	1 Pole	15	250	15	10	8	M80	1P + N + E	[1.5,6]	204	101	83	56P315	B
56C332-WW	1 Pole	32	250	32	32	28	M180	1P + N + E	[6,16]	204	101	108	56P332	I
56C510-WW	3 Pole	10	500	10	10	11	M100	3P + N + E	[1.5,6]	204	101	108	56P510	Q
56C520-WW	3 Pole	20	500	20	20	21	M150	3P + N + E	[2.5,6]	204	101	108	56P520	R
56C532LE-WW	3 Pole	32	500	32	32	28	M180	3P + N + E	[4,16]	204	101	72	56P532	S
56C532-WW	3 Pole	32	500	32	32	28	M180	3P + N + E	[4,16]	204	101	108	56P532	S
56C550LE-WW	3 Pole	50	500	50	50	35	M250	3P + N + E	[10,16]	204	101	72	56P550	U
56C550-WW	3 Pole	50	500	50	50	35	M250	3P + N + E	[10,16]	204	101	108	56P550	U

Surface Socket Outlets

Surface Socket Outlets range in size from 32 V, 10 A to 500 V, 50 A. All sockets feature hoseproof and dust resistant flaps with automatic snap catch latches. The transparent flap enables instant visual inspection of socket condition and pin configuration.

The full range of sockets accommodates the current IP66 retention ring plugs in order to rationalise the number of variations required. Earth and neutral connectors accommodating 3 x 6 mm² cable are supplied with all 500 V models. Terminal housings are moulded in tough polyester to minimise damage.

Less Enclosure versions are indicated with letters LE in the reference.



Alkaline - Clipsal 56 Series

Catalogue Number	I _{the} (Amp)	Ui / Ue (Volt)	Type of Socket	Cond. Term Size in mm	O/A Dims.			Colour	Matching Plug	Socket Config
					Min.	Max/Cond.	(H) (W) (D)			
56SO210-CG	10	110	1P + N	[1.5,6]	107	101	77	Chemical Grey	56P210	D
56SO310-CG	10	250	1P + N + E	[1.5,6]	107	101	77	Chemical Grey	56P310	A
56SO310-WW	10	250	1P + N + E	[1.5,6]	107	101	77	Dark Grey	56P310	A
56SO310L-CG	10	250	1P + N + E	[1.5,6]	107	101	77	Chemical Grey	56P310L	C
56SO310L-WW	10	250	1P + N + E	[1.5,6]	107	101	77	Dark Grey	56P310L	C
56SO310LE-CG	10	250	1P + N + E	[1.5,6]	107	101	64	Chemical Grey	56P310	A
56SO315LE-CG	15	250	1P + N + E	[2.5,6]	107	101	64	Chemical Grey	56P315	B
56SO320-CG	20	250	1P + N + E	[2.5,6]	107	101	102	Chemical Grey	56P320	H
56SO320FLE-CG	20	250	1P + N + E	[2.5,6]	107	101	64	Chemical Grey	56P320F	F
56SO410-CG	10	500	3P + E	[1.5,6]	107	101	102	Chemical Grey	56P410	K
56SO420-CG	20	500	3P + E	[2.5,6]	107	101	102	Chemical Grey	56P420	L
56SO432-CG	32	500	3P + E	[4,16]	107	101	102	Chemical Grey	56P432	U
56SO510-CG	10	500	3P + N + E	[1.5,6]	107	101	102	Chemical Grey	56P510	Q
56SO510LE-CG	10	500	3P + N + E	[1.5,6]	107	101	71	Chemical Grey	56P510	Q
56SO520-CG	20	500	3P + N + E	[2.5,6]	107	101	102	Chemical Grey	56P520	R
56SO520LE-CG	20	500	3P + N + E	[2.5,6]	107	101	71	Chemical Grey	56P520	R
56SO532-CG	32	500	3P + N + E	[4,16]	107	101	102	Chemical Grey	56P532	S
56SO532LE-CG	32	500	3P + N + E	[4,16]	107	101	74	Chemical Grey	56P532	S
56SO550-CG	50	500	3P + N + E	[10,16]	107	101	102	Chemical Grey	56P550	U
56SO550-WW	50	500	3P + N + E	[10,16]	107	101	102	Dark Grey	56P550	U

Dimensions (mm)

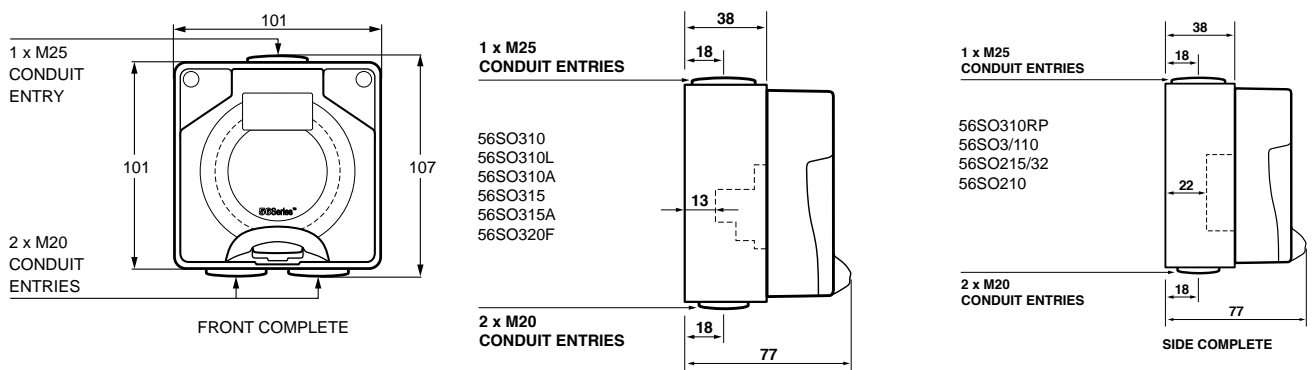

Switches

Surface Switches

The 56 Series Surface Switches are available from 250 V, 10 A to 500 V, 63 A. They incorporate a positive, rotary switch action. 'ON' and 'OFF' positions are clearly marked and there is provision for two padlocks. Hole diameter is 8 mm. If locking is required in the 'ON' position, simply drill a hole where necessary. To provide easier wiring of our 56 Series Three Pole 63 A Switch, a deeper two gang enclosure and centrally mounted option (Cat. No. 56SW363/2), allows additional room for wiring associated with this application. Earth and neutral connectors accommodating 3 x 6 mm² cables are supplied with all products above 20 A. All 63 A switches come with the facility to fit auxiliary micro switch 56SWAUX15.



Note: AC utilisation categories to AS/NZS3947.3 I_{the} - Conventional Enclosed Thermal Current I_e - Operational Current U_i - Insulation Voltage U_e - Operational Voltage. For Fluorescent Loads use 56SW110HD or 56SW115HD instead of 56SW110 or 56SW115 Less Enclosure versions contain the letters LE in the reference

Alkaline - Clipsal 56 Series

Catalogue Number	No. of Switch Poles	I _{the} (Amp)	U _i / U _e (Volt)	I _e (A) Utilisation Category			M Rating	Cond. Term Size in mm	O/A Dims.			Colour
				AC21A	AC22A	AC23A			Min.Max/Cond.	(H)	(W)	
Chemical Resistant Grey (CG)												
56SW110/I-CG	1P	10	250	10	8	8	M80	[1,5,6]	107	101	83	Chemical Grey
56SW110/2-CG	1P	10	250	10	8	8	M80	[1,5,6]	107	101	83	Chemical Grey
56SW110-CG	1P	10	250	10	8	8	M80	[1,5,6]	107	101	83	Chemical Grey
56SW110LE-CG	1P	10	250	10	8	8	M80	[1,5,6]	107	101	70	Chemical Grey
56SW110HD-CG	1P	10	250	10	10	10	M100	[6,16]	107	101	108	Chemical Grey
56SW115/2-CG	1P	15	250	15	8	8	M80	[1,5,6]	107	101	83	Chemical Grey
56SW115/2LE-CG	1P	15	250	15	8	8	M80	[1,5,6]	107	101	70	Chemical Grey
56SW115-CG	1P	15	250	15	8	8	M80	[1,5,6]	107	101	83	Chemical Grey
56SW115LE-CG	1P	15	250	15	8	8	M80	[1,5,6]	107	101	70	Chemical Grey
56SW120-CG	1P	20	250	20	20	20	M150	[2,5,16]	107	101	108	Chemical Grey
56SW120LE-CG	1P	20	250	20	20	20	M150	[2,5,16]	107	101	72	Chemical Grey
56SW132-CG	1P	32	250	32	32	28	M180	[4,16]	107	101	108	Chemical Grey
56SW310-CG	3P	10	500	10	10	10	M100	[1,5,16]	107	101	108	Chemical Grey
56SW310LE-CG	3P	10	500	10	10	10	M100	[1,5,16]	107	101	72	Chemical Grey
56SW320CX-CG	3P	20	500	20	20	20	M150	[2,5,16]	107	101	108	Chemical Grey
56SW320CXLE-CG	3P	20	500	20	20	20	M150	[2,5,16]	107	101	72	Chemical Grey
56SW320-CG	3P	20	500	20	20	20	M150	[2,5,16]	107	101	108	Chemical Grey
56SW320LE-CG	3P	20	500	20	20	20	M150	[2,5,16]	107	101	72	Chemical Grey
56SW332-CG	3P	32	500	32	32	28	M180	[4,16]	107	101	108	Chemical Grey
56SW332LE-CG	3P	32	500	32	32	28	M180	[4,16]	107	101	72	Chemical Grey
56SW350-CG	3P	50	500	50	50	25	M250	[10,25]	107	101	108	Chemical Grey
56SW363/2-CG	3P	63	500	63	63	25	M300	[16,25]	204	101	108	Chemical Grey
56SW363-CG	3P	63	500	63	63	25	M300	[16,25]	107	101	108	Chemical Grey
56SW420-CG	4P	20	500	20	20	20	M150	[2,5,6]	107	101	108	Chemical Grey
56SW420LE-CG	4P	20	500	20	20	20	M150	[2,5,6]	107	101	72	Chemical Grey
Dark Grey (CG)												
56SW110-WW	1P	10	250	10	8	8	M80	[1,5,6]	107	101	83	Dark Grey
56SW110LE-WW	1P	10	250	10	8	8	M80	[1,5,6]	107	101	70	Dark Grey
56SW115-WW	1P	15	250	15	8	8	M80	[1,5,6]	107	101	83	Dark Grey
56SW120-WW	1P	20	250	20	20	20	M150	[2,5,16]	107	101	108	Dark Grey
56SW132-WW	1P	32	250	32	32	28	M180	[4,16]	107	101	108	Dark Grey
56SW320-WW	3P	20	500	20	20	20	M150	[2,5,16]	107	101	108	Dark Grey
56SW332-WW	3P	32	500	32	32	28	M180	[4,16]	107	101	108	Dark Grey
56SW363-WW	3P	63	500	63	63	25	M300	[16,25]	107	101	108	Dark Grey

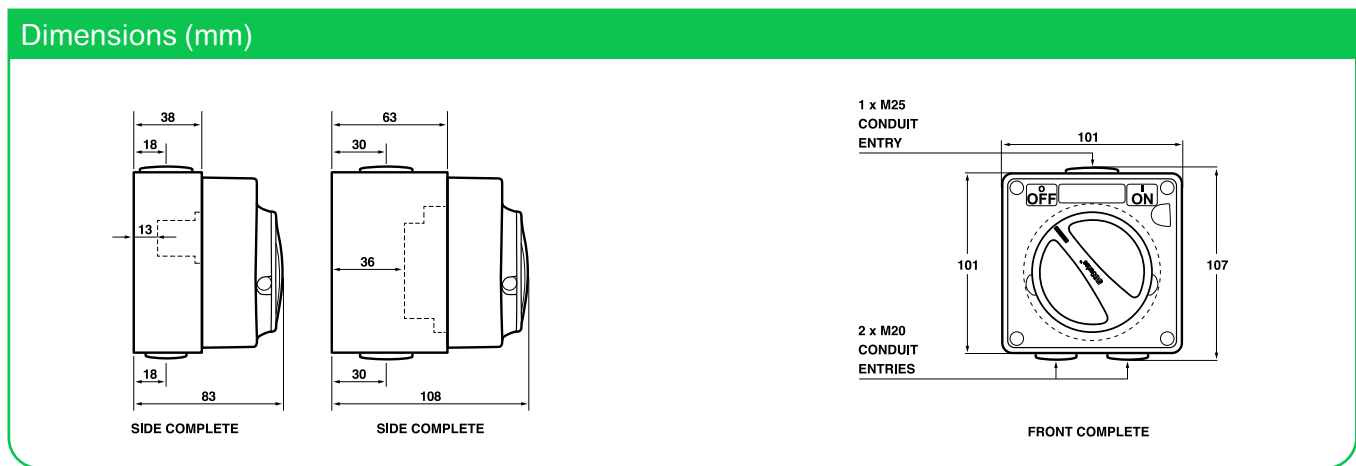

Push Button Control Stations

This rugged range consists of five different combinations of stop start control stations. The stations are ideal in wet, dusty, or dirty conditions for controlling motor starters on pumps, saws, compressors, lathes, processors, and processing lines.

56PBS1 - Emergency stop station. This station has a red mushroom head push button with twist reset.

56PBS2 - Stop station. This station has a red mushroom head push button with twist reset. (Labelled stop only).

Alkaline - Clipsal 56 Series

Catalogue Number	No. of Switched Poles	I_{the} (Amp)	U_i / U_e (Volt)	Utilisation Category			M Rating	Cond. Term Size in mm		O/A Dims.			Colour
				AC21A	AC22A	AC23A		Min.Max/Cond.	(H)	(W)	(D)		
56PBS1-CG	1P	0	500	0	0	0	0	[1,4]	107	101	102	Chemical Grey	
56PBS2-CG	1P	0	500	0	0	0	0	[1,4]	107	101	102	Chemical Grey	

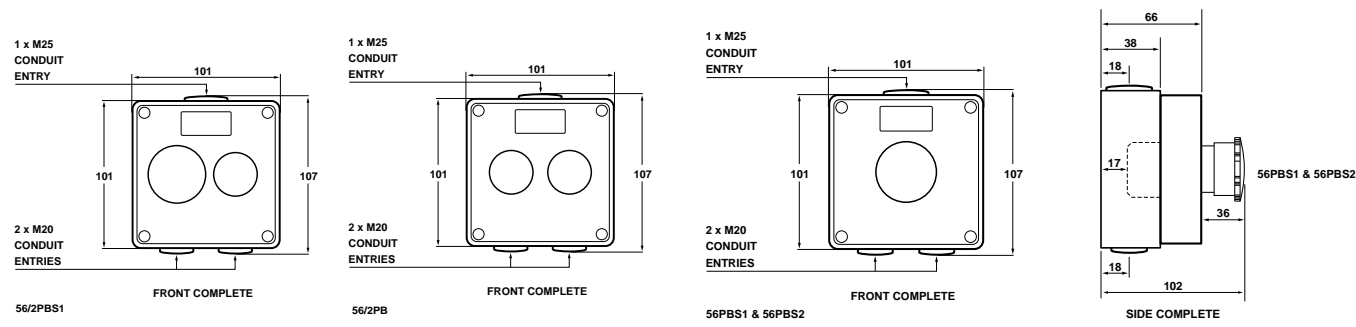
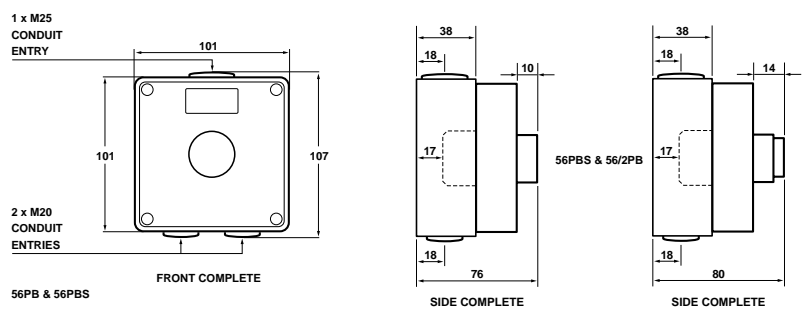

Plugs

The 56 Series range of plugs and connectors has a proud history for being the toughest and most trusted industrial switchgear on the market.

Built tough to last, the plastics used to manufacture the 56 Series range are of industrial grade resins with high impact strength, UV protection, and chemical resistance.

Pin configurations for plugs, sockets, and switched socket outlets comply with three-phase AS/NZS3123, single-phase AS/NZS3112. The introduction of transparent materials to the Electric Orange and Grey range enables the inspection and checking of the component's pin/socket configuration and wiring at a glance, while still providing protection against the elements.



Single Phase 250V plug



56P series (straight plug) in Electric Orange



56PA series (angled plug) in Resistant Orange

Single-Phase Plugs

Alkaline - Clipsal 56 Series								
Catalogue Number	Rated Current	Rated Voltage	Pin Description	Conductor Terminal mm ²	Cable Nominal Dia.	Colour	Pin Configuration	Gland Nut Thread
	(A)	(V)		Min/Max	Min/Max			
Electric Orange (EO)								
56P210-EO	10	250	1P + N	[0.75,1]	[7,10]	Orange	D	M20
56P215/32-EO	15	32	Polarised	[1.5,1.5]	[7,10]	Orange	E	M20
56P3/110-EO	10	110	1P + N + E	[0.75,1]	[7,10]	Orange	H	M20
56P310-EO	10	250	1P + N + E	[0.75,1]	[7,10]	Orange	A	M20
56P310RP-EO	10	250	1P + N + E	[0.75,1]	[7,10]	Orange	G	M20
56P310SL-EO	10	250	1P + N + E	[0.75,1]	[7,10]	Orange	F	M20
56P313-EO	13	250	1P + N + E	[0.75,1]	[7,10]	Orange	BS	M20
56P315-EO	15	250	1P + N + E	[1.5,1.5]	[7,10]	Orange	B	M20
56P320-EO	20	250	1P + N + E	[1,6]	[7,16]	Orange	Q	56AM25
56P320F-EO	20	250	1P + N + E	[1,6]	[10,17.5]	Orange	C	M20
56P332-EO	32	250	1P + N + E	[2.5,25]	[9,29]	Orange	I	56AM40
56PA320-EO	20	250	1P + N + E	[1,6]	[7,16]	Orange	Q	56AM25
56PA332-EO	32	250	1P + N + E	[2.5,25]	[9,29]	Orange	I	56AM40
Resistant Orange (RO)								
56P210-RO	10	250	1P + N	[0.75,1]	[7,10]	Orange	D	M20
56P215/32-RO	15	32	Polarised	[1.5,1.5]	[7,10]	Orange	E	M20
56P310-RO	10	250	1P + N + E	[0.75,1]	[7,10]	Orange	A	M20
56P310RP-RO	10	250	1P + N + E	[0.75,1]	[7,10]	Orange	G	M20
56P310SL-RO	10	250	1P + N + E	[0.75,1]	[7,10]	Orange	F	M20
56P315-RO	15	250	1P + N + E	[1.5,1.5]	[7,10]	Orange	B	M20
56P320-RO	20	250	1P + N + E	[1,6]	[7,16]	Orange	Q	56AM25
56P320F-RO	20	250	1P + N + E	[1,6]	[10,17.5]	Orange	C	M20
56PA320-RO	20	250	1P + N + E	[1,6]	[7,16]	Orange	Q	56AM25
56PA332-RO	32	250	1P + N + E	[2.5,25]	[9,29]	Orange	I	56AM40

Three phase 10 A - 20 A Plugs (Size 1)

Alkaline - Clipsal 56 Series - Straight Plugs								
Catalogue Number	Rated Current	Rated Voltage	Pin Description	Conductor Terminal mm ²	Cable Nominal Dia.	Colour	Pin Configuration	Gland Nut Thread
	(A)	(V)		Min/Max	Min/Max			
56P410-EO	10	500	3P + E	[1,6]	[7,16]	Orange	P	56AM25
56P416K-EO	16	500	3P + E	[1,6]	[7,16]	Orange	S	56AM25
56P420-EO	20	500	3P + E	[1,6]	[7,16]	Orange	R	56AM25
56P510-EO	10	500	3P + N + E	[1,6]	[7,16]	Orange	T	56AM25
56P520-EO	20	500	3P + N + E	[1,6]	[7,16]	Orange	U	56AM25
56P610-EO	10	500	3P + N + E	[1,6]	[7,16]	Orange	V	56AM25
56P710-EO	10	500	3P + N + E	[1,6]	[7,16]	Orange	W	56AM25
56P720-EO	20	500	3P + N + E	[1,6]	[7,16]	Orange	X	56AM25
56P410-RO	10	500	3P + E	[1,6]	[7,16]	Orange	P	56AM25
56P416K-RO	16	500	3P + E	[1,6]	[7,16]	Orange	S	56AM25
56P420-RO	20	500	3P + E	[1,6]	[7,16]	Orange	R	56AM25
56P510-RO	10	500	3P + N + E	[1,6]	[7,16]	Orange	T	56AM25
56P520-RO	20	500	3P + N + E	[1,6]	[7,16]	Orange	U	56AM25
56P710-RO	10	500	3P + N + E	[1,6]	[7,16]	Orange	W	56AM25
56P720-RO	20	500	3P + N + E	[1,6]	[7,16]	Orange	X	56AM25

Alkaline - Clipsal 56 Series - Angled Plugs								
Catalogue Number	Rated Current	Rated Voltage	Pin Description	Conductor Terminal mm ²	Cable Nominal Dia.	Colour	Pin Configuration	Gland Nut Thread
	(A)	(V)		Min/Max	Min/Max			
56PA410-EO	10	500	3P + E	[1,6]	[7,16]	Orange	P	56AM25
56PA416K-EO	16	500	3P + E	[1,6]	[7,16]	Orange	S	56AM25
56PA420-EO	20	500	3P + E	[1,6]	[7,16]	Orange	R	56AM25
56PA510-EO	10	500	3P + N + E	[1,6]	[7,16]	Orange	T	56AM25
56PA520-EO	20	500	3P + N + E	[1,6]	[7,16]	Orange	U	56AM25
56PA610-EO	10	500	3P + N + E	[1,6]	[7,16]	Orange	V	56AM25
56PA710-EO	10	500	3P + N + E	[1,6]	[7,16]	Orange	W	56AM25
56PA720-EO	20	500	3P + N + E	[1,6]	[7,16]	Orange	X	56AM25
56PA410-RO	10	500	3P + E	[1,6]	[7,16]	Orange	P	56AM25
56PA416K-RO	16	500	3P + E	[1,6]	[7,16]	Orange	S	56AM25
56PA420-RO	20	500	3P + E	[1,6]	[7,16]	Orange	R	56AM25
56PA510-RO	10	500	3P + N + E	[1,6]	[7,16]	Orange	T	56AM25
56PA520-RO	20	500	3P + N + E	[1,6]	[7,16]	Orange	U	56AM25
56PA710-RO	10	500	3P + N + E	[1,6]	[7,16]	Orange	W	56AM25
56PA720-RO	20	500	3P + N + E	[1,6]	[7,16]	Orange	X	56AM25

Three Phase 32 A - 50 A Plugs (Size 2)

Alkaline - Clipsal 56 Series								
Catalogue Number	Rated Current	Rated Voltage	Pin Description	Conductor Terminal mm ²	Cable Nominal Dia.	Colour	Pin Configuration	Gland Nut Thread
	(A)	(V)		Min/Max	Min/Max			
Electric Orange (EO)								
56P432-EO	32	500	3P + E	[2.5,25]	[9,29]	Orange	J	56AM40
56P440-EO	40	500	3P + E	[2.5,25]	[9,29]	Orange	K	56AM40
56P450-EO	50	500	3P + E	[2.5,25]	[9,29]	Orange	L	56AM40
56P532-EO	32	500	3P + N + E	[2.5,25]	[9,29]	Orange	M	56AM40
56P540-EO	40	500	3P + N + E	[2.5,25]	[9,29]	Orange	N	56AM40
56P550-EO	50	500	3P + N + E	[2.5,25]	[9,29]	Orange	O	56AM40
56PA332-EO	32	250	1P + N + E	[2.5,25]	[9,29]	Orange	I	56AM40
56PA432-EO	32	500	3P + E	[2.5,25]	[9,29]	Orange	J	56AM40
56PA440-EO	40	500	3P + E	[2.5,25]	[9,29]	Orange	K	56AM40
56PA450-EO	50	500	3P + E	[2.5,25]	[9,29]	Orange	L	56AM40
56PA532-EO	32	500	3P + N + E	[2.5,25]	[9,29]	Orange	M	56AM40
56PA540-EO	40	500	3P + N + E	[2.5,25]	[9,29]	Orange	N	56AM40
56PA550-EO	50	500	3P + N + E	[2.5,25]	[9,29]	Orange	O	56AM40
Resistant Orange (RO)								
56P432-RO	32	500	3P + E	[2.5,25]	[9,29]	Orange	J	56AM40
56P440-RO	40	500	3P + E	[2.5,25]	[9,29]	Orange	K	56AM40
56P532-RO	32	500	3P + N + E	[2.5,25]	[9,29]	Orange	M	56AM40
56PA332-RO	32	250	1P + N + E	[2.5,25]	[9,29]	Orange	I	56AM40
56PA432-RO	32	500	3P + E	[2.5,25]	[9,29]	Orange	J	56AM40
56PA432-RO	32	500	3P + E	[2.5,25]	[9,29]	Orange	J	56AM40
56PA450-RO	50	500	3P + E	[2.5,25]	[9,29]	Orange	L	56AM40
56PA532-RO	32	500	3P + N + E	[2.5,25]	[9,29]	Orange	M	56AM40
56PA550-RO	50	500	3P + N + E	[2.5,25]	[9,29]	Orange	O	56AM40

Dimensions (mm)

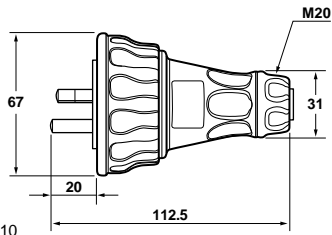

- 56P210
- 56P215/32
- 56P3/110
- 56P310RP
- 56P310
- 56P310SL
- 56P315
- 56P320F

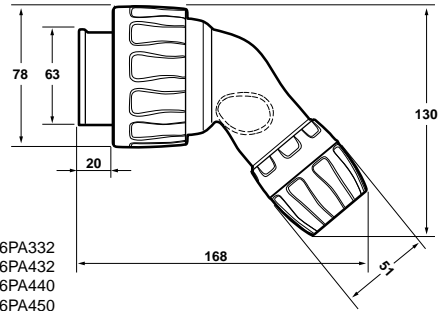

- 56PA332
- 56PA432
- 56PA440
- 56PA450
- 56PA532
- 56PA540
- 56PA550

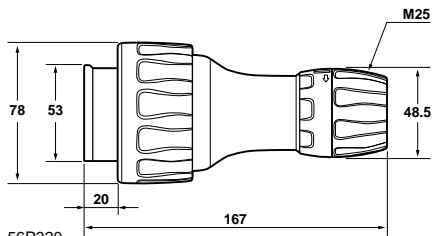

- 56P320
- 56P410
- 56P420
- 56P510
- 56P520
- 56P416K
- 56P610
- 56P710
- 56P720

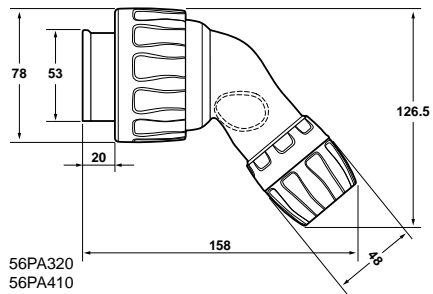

- 56PA320
- 56PA410
- 56PA416K
- 56PA420
- 56PA510
- 56PA520
- 56PA610
- 56PA710
- 56PA720

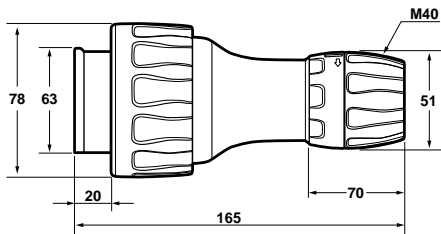

- 56P332
- 56P532
- 56P540
- 56P550
- 56P432
- 56P440
- 56P450

Extension Sockets and Appliance Connectors

Extension Sockets and Appliance Connectors

The 56 Series Extension Socket/Appliance Connector range is an important design breakthrough. It provides a common unit for both cord extension socket and appliance connector applications.

All connectors have impact-resistant, UV-stabilised mouldings. The IP66 rating can be achieved when extension sockets or connectors are used in conjunction with compatible accessories such as 56P Plugs, 56PA Plugs, and 56AI Appliance Inlets.

The IP66 rated units feature a flap, which maintains the International Protection Rating when the accessory is not being used.

Note: Flap is not provided as standard with smaller single-phase extension sockets.

The 56AM25 Adapter suits 25 mm cable and conduit glands, and is suitable on 10 A and 20 A units (three-phase).

The 56AM40 Adapter suits 40 mm cable and conduit glands, and is suitable on 32 A and 50 A units (three-phase).



Alkaline - Clipsal 56 Series

Catalogue Number	Rated Current (A)	Rated Voltage (V)	Conductor Terminal mm ² Min./Max	Cable Nominal Dia. Min./Max	Socket Description	Pin Configuration	Gland Nut Thread	Matching Straight	Matching Angled Plug	Colour
56CSC310-RO	10	250	[0.75,1.5]	[7,16]	1P + N + E	A	M20	56P310-RO -	-	Orange
56CSC315-RO	15	250	[0.75,1.5]	[7,16]	1P + N + E	B	M20	56P315-RO -	-	Orange
56CSC310-EO	10	250	[0.75,1.5]	[7,16]	1P + N + E	A	M20	56P310-EO -	-	Electric Orange
56CSC315-EO	15	250	[0.75,1.5]	[7,16]	1P + N + E	B	M20	56P315-EO -	-	Electric Orange
56CSC320-EO	20	250	[1,6]	[7,16]	1P + N + E	Q	56AM25	56P320-EO	56PA320-EO	Electric Orange
56CSC332-EO	32	250	[2.5,25]	[9,29]	1P + N + E	I	56AM40	56P332-EO	56PA332-EO	Electric Orange
56CSC410-EO	10	500	[1,6]	[7,16]	3P + E	P	56AM25	56P410-EO	56PA410-EO	Electric Orange
56CSC420-EO	20	500	[1,6]	[7,16]	3P + E	R	56AM25	56P420-EO	56PA420-EO	Electric Orange
56CSC432-EO	32	500	[2.5,25]	[9,29]	3P + E	J	56AM40	56P432-EO	56PA432-EO	Electric Orange
56CSC440-EO	40	500	[2.5,25]	[9,29]	3P + E	K	56AM40	56P440-EO	56PA440-EO	Electric Orange
56CSC450-EO	50	500	[2.5,25]	[9,29]	3P + E	L	56AM40	56P450-EO	56PA450-EO	Electric Orange
56CSC510-EO	10	500	[1,6]	[7,16]	3P + N + E	T	56AM25	56P510-EO	56PA510-EO	Electric Orange
56CSC520-EO	20	500	[1,6]	[7,16]	3P + N + E	U	56AM25	56P520-EO	56PA520-EO	Electric Orange
56CSC532-EO	32	500	[2.5,25]	[9,29]	3P + N + E	M	56AM40	56P532-EO	56PA532-EO	Electric Orange
56CSC540-EO	40	500	[2.5,25]	[9,29]	3P + N + E	N	56AM40	56P540-EO	56PA540-EO	Electric Orange
56CSC550-EO	50	500	[2.5,25]	[9,29]	3P + N + E	O	56AM40	56P550-EO	56PA550-EO	Electric Orange

Dimensions (mm)

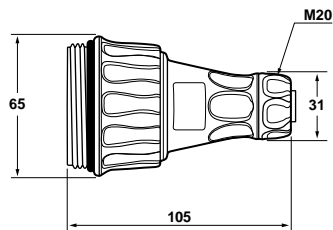

56CSC310
56CSC315

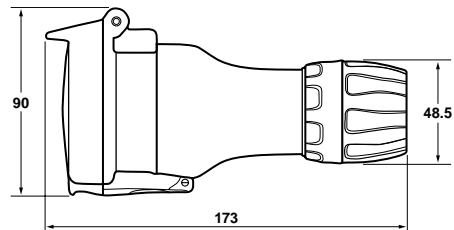

56CSC320
56CSC410
56CSC420
56CSC510
56CSC520

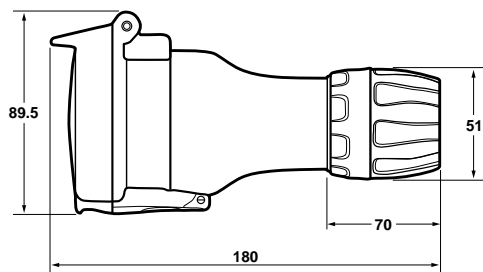

56CSC332
56CSC432
56CSC440
56CSC450
56CSC532
56CSC540
56CSC550

Pendant Outlets

Clipsal 56PO three-phase Pendant Outlets are a hanging version of the 56CSC Connectors. The Pendant Outlets range from 56PO410 to 56PO550, and all have impact-resistant UV-stabilised mouldings.

56CSC Connectors can be converted to Pendant Outlets with the use of 56SHL or 56SHM suspension hooks.

Switched Pendant Outlets

The 56 Series Switched Pendant Outlet combines performance, and functionality.

The 56SP0310 and 56SP0315 are available within this range.



Alkaline - Clipsal 56 Series

Catalogue Number	Rated Current (A)	Rated Voltage (V)	Conductor Terminal mm ² Min./Max	Cable Nominal Dia. Min./Max	Socket Description	Pin Configuration	Gland Nut Thread	Matching Straight	Matching Angled Plug	Colour
56PO420-EO	20	500	[1,6]	[7,16]	3P + E	R	56AM25	56P420-EO	56PA420-EO	Electric Orange
56PO432-EO	32	500	[2.5,25]	[9,29]	3P + E	J	56AM40	56P432-EO	56PA432-EO	Electric Orange
56PO510-EO	10	500	[1,6]	[7,16]	3P + N + E	T	56AM25	56P510-EO	56PA510-EO	Electric Orange
56PO520-EO	20	500	[1,6]	[7,16]	3P + N + E	U	56AM25	56P520-EO	56PA520-EO	Electric Orange
56PO532-EO	32	500	[2.5,25]	[9,29]	3P + N + E	M	56AM40	56P532-EO	56PA532-EO	Electric Orange
56PO550-EO	50	500	[2.5,25]	[9,29]	3P + N + E	O	56AM40	56P550-EO	56PA550-EO	Electric Orange
56SPO310-RW	10	250	[0.75,2.5]	[7,10]	1P + N + E	A	M20	56P310	-	White
56SPO315-RW	15	250	[0.75,2.5]	[7,10]	1P + N + E	B	M20	56P315	-	White

Dimensions (mm)

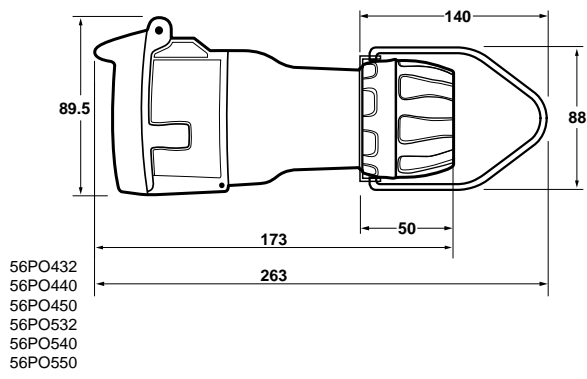
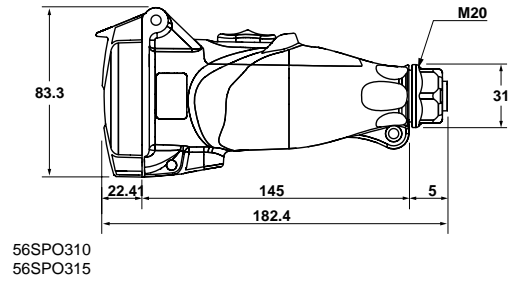
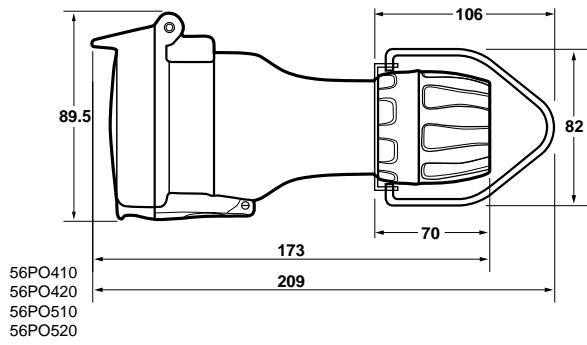

Mounting Enclosures (Lids & Back Boxes)

Mounting Enclosures (Back Boxes)

All 56 Series Mounting Back Boxes are moulded in UV stabilised rigid PVC to facilitate glueing of fittings for conduit entry. Ample conduit and cable entries are provided and there is plenty of wiring room for easy installation.

All screwed conduit entries are provided with plugs. The multigang enclosures feature moulded bridges between modules so switches and sockets sit flush on a continuous surface. Moulded dividers are also available for multigang boxes to segregate services and are standard with 4, 6, 8, 9, and 16 gang enclosures.

Each enclosure has a number of mounting points and 220/10 Sealing Plugs are provided to double insulate mounting screw heads and maintain the IP rating.

Moulded gaskets are supplied with switch and socket modules.



Alkaline - Clipsal 56 Series

Catalogue Number	No. of Gangs	O/A Dimensions			Matching Points	No. of Conduit Entries (mm)	Cut-out Provision (mm)	Colour	Bridges	Dividers
		(H)	(W)	(D)						
56E1-CG	1	102	102	63	8	2 x 25 mm - 1 x 32 mm	1 x 25/32	Dark Grey	0	0
56ES1-CG	1	102	102	40	8	2 x 25 mm - 1 x 32 mm	1 x 20/25	Dark Grey	0	0
56E2-CG	2	198	102	63	8	2 x 25 mm - 1 x 32 mm	1 x 25, 1 x 32	Dark Grey	1	0
56EV2-CG	2 Vertical	110	145	110	4	2 x 25 mm - 1 x 32 mm	0	Dark Grey	0	0
56ED2-CG	2	198	102	100	16	3 x 40 mm	1 x 25, 1 x 32	Dark Grey	1	0
56E3-CG	3	294	102	63	8	2 x 25 mm - 1 x 32 mm	2 x 25, 1 x 32	Dark Grey	2	0
56E4-CG	4	198	198	63	24	2 x 25 mm - 4 x 32 mm	2 x 25, 1 x 32, 1 x 40	Dark Grey	2	2
56E6-CG	6	296	198	63	0	2 x 25 mm - 2 x 32 mm	2 x 25, 2 x 32, 2 x 40	Dark Grey	3	4
56E8-CG	8	396	198	63	0	2 x 25 mm - 2 x 32 mm	4 x 25, 2 x 32, 2 x 40	Dark Grey	4	6
56E1-WW	1	102	102	63	16	2 x 25 mm - 1 x 32 mm	1 x 25/32	Dark Grey	0	0
56E2-WW	2	198	102	63	16	2 x 25 mm - 1 x 32 mm	1 x 25, 1 x 32	Dark Grey	1	0
56E3-WW	3	294	102	63	4	2 x 25 mm - 1 x 32 mm	2 x 25, 1 x 32	Dark Grey	2	0
56E4-WW	4	198	198	63	28	2 x 25 mm - 4 x 32 mm	2 x 25, 1 x 32, 1 x 40	Dark Grey	2	2
56E8-WW	8	396	198	63	48	2 x 25 mm - 2 x 32 mm	4 x 25, 2 x 32, 2 x 40	Dark Grey	4	6

Dimensions (mm)

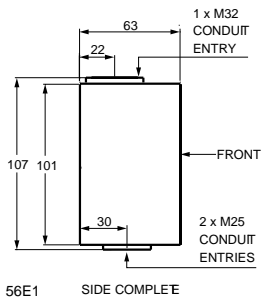

56E1 SIDE COMPLETE

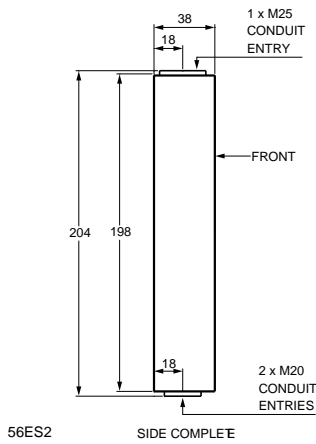

56ES2 SIDE COMPLETE

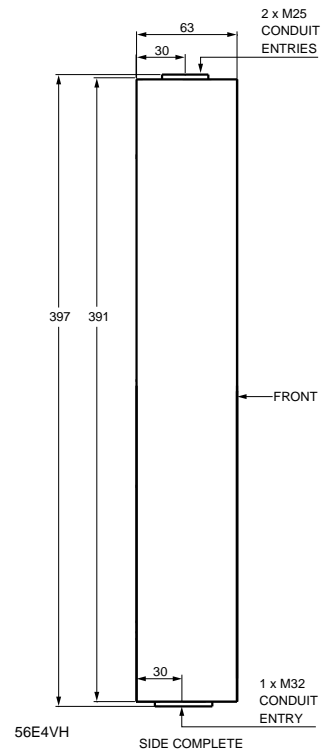

56E4VH SIDE COMPLETE

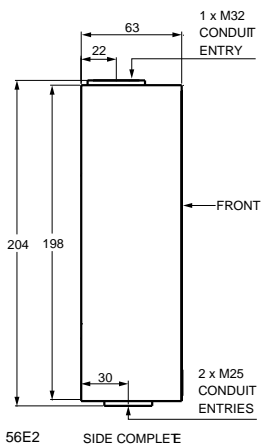

56E2 SIDE COMPLETE

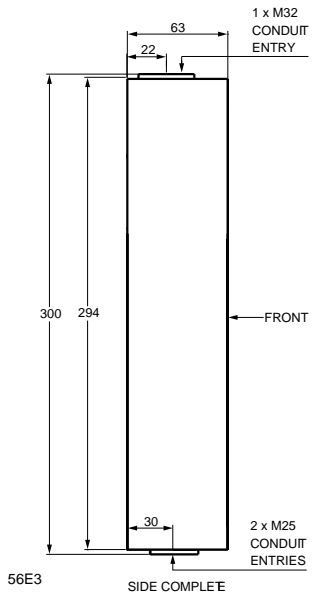

56E3 SIDE COMPLETE

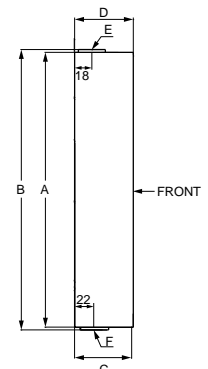

56E6, 56E9 SIDE COMPLETE

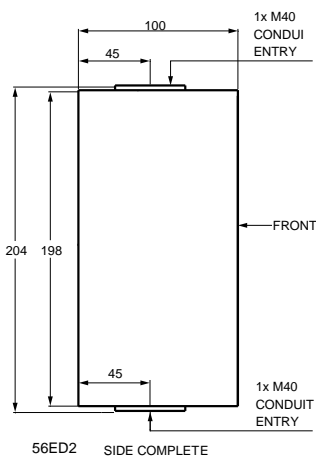

56ED2 SIDE COMPLETE

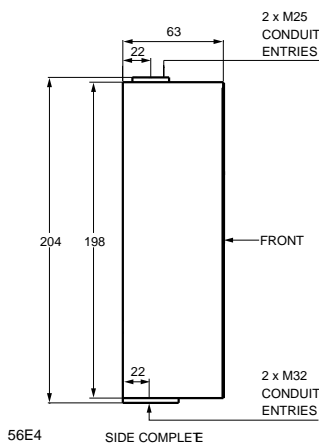

56E4 SIDE COMPLETE

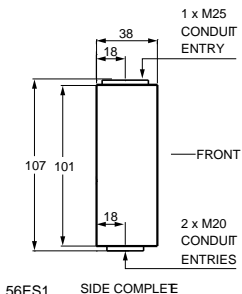

56ES1 SIDE COMPLETE

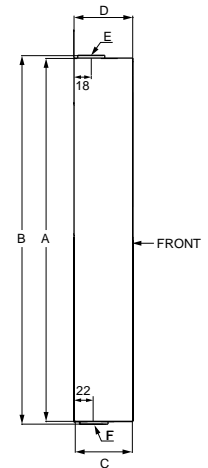

56E8, 56E16 SIDE COMPLETE

Catalogue Number	No. Gangs	Dimensions(mm)				Conduit Entries		Cut Out Provisions			56 DV Dividers	56B Bridges	Mounting Points
		A	B	C	D	E	F	G	H	I			
56E6	6	294	300	198	63	2 x M25	2 x M32	25	32	40	4	3	24
56E8	8	392	398	198	63	2 x M25	2 x M32	25	32	40	6	4	28
56E9	9	294	300	294	63	3 x M25	3 x M32	25	32	40	6	6	28
56E16	16	392	398	392	63	2 x M25	2 x M32	25	32	40	12	8	48

Mounting Enclosure Lids (Covers)

- Mounting enclosure lids are UV stabilised.
- All are 28 mm high and supplied complete with sealing gasket.
- One gang, 28 mm high lids are also available pre-drilled to accept 22 mm or 30.5 mm diameter IP56 rated push- buttons or indicating lights. Dimensions are identical to the 56L1.



Alkaline - Clipsal 56 Series

Catalogue Number	No. of Gangs	O/A Dimensions						Pre Drilled Hole Diameter (mm)	Hole Quantity	Colour
		A	B	C	D	E	F			
56L1-CG	1	95	95	28	84	84	-	-	-	Chemical Grey
56L1-WW	1	95	95	28	84	84	-	-	-	Dark Grey
56L2-CG	2	192	95	28	84	181	-	-	-	Chemical Grey
56L2-WW	2	192	95	28	84	181	-	-	-	Dark Grey
56L1/22/2-CG	1	95	95	28	84	84	20	22	2	Chemical Grey
56L1/22-CG	1	95	95	28	84	84	-	22	1	Chemical Grey

Adaptable Enclosures

DIN Rail Accessory Mounting Cover Kits

The 56 Series Two Gang Cover Assemblies feature a specially designed mounting bracket which will accommodate the full range of Schneider Electric circuit breakers, RCDs, and combination of MCB/RCDs.

Covers suit all 56 Series enclosures (minimum standard depth 63mm) and are supplied with neon indicators, which can be wired from either the line or load side of the switch.

The unique 56CB4NM protective membrane, incorporated into the unit, covers MCBs, RCDs, and accessories to provide a barrier against dust and water, including wet hands when the flap is opened to reset switches.

All 56CB4 include a padlocking facility on the cover flap.



Alkaline - Clipsal 56 Series

Catalogue Number	Ui/Ue (Volt)	Neon Voltage (Volt)	Module Type	No. of Poles	Module Width	O/A Dimensions			Colour
						L (mm)	W (mm)	D (mm)	
56CB4N-CG	240 / 440	240 / 415	1P, 2P, 3P MCB	4 RCD	4 Max	190	95	50	Chemical Grey
56CB4NM-CG	240 / 440	240 / 415	1P, 2P, 3P MCB	4 RCD	4 Max	190	95	50	Chemical Grey

Adaptable Enclosures



56M41-CG



56M42-CG

Neutral - Clipsal 56 Series

Catalogue Number	No. of Gangs	No. of Mounting points	Cut Outs	O/A Dimensions			Colour	Compatibility
				(H)	(W)	(D)		
56/32-CG	1	4	2	101	101	77	chemical grey	Clipsal 30 Mech
56/01X-WW	1	4	-	101	101	77	dark grey	-
56M41-CG	1	4	1	101	101	77	grey	Clipsal 40 Module
56M42-CG	1	4	2	101	101	77	chemical grey	Clipsal 40 Module

Junction Boxes

The 56 Series Junction Boxes are designed for industrial environments. They are supplied complete with Earth and Neutral connectors for up to 3 x 6 mm² cables and sealing gasket.

The 25 mm and 32 mm screwed conduit entries and sealing plugs are provided, as are cable entry cut outs in the back.



Alkaline - Clipsal 56 Series

Catalogue Number	No. of Gangs	Cut Outs	O/A Dimensions			Colour
			(H)	(W)	(D)	
56JB1-CG	1	1 x 25/32	101	101	91	Chemical Grey

Accessories and Spare Parts

Switch, Socket, and Switched Socket Outlet Accessories

- Auxiliary Switch - 56 Series Catalogue Number 56SOAUX15 Suits 415 V sockets. This switch is used to indicate if plug is connected or not.
- Auxiliary Switch - 56 Series Catalogue Number 56SWAUX15 Suits 63 A switches. This switch is used to indicate if switch is 'ON' or 'OFF'.
- Single Phase Red LED Catalogue Number 56LEDK1 Field fit kits includes LED on flying leads, lens, o-ring, drill bit 5.5 mm (7/32), and instructions.
- Three Phase Red, White, Blue LED Catalogue Number 56LEDK3 Field fit kits includes LED on flying leads, lens, o-ring, drill bit 5.5 mm (7/32), and instructions.
- LEDs provide more reliability and extended life compared to traditional neons used in 56 Series.
- Lock for Socket Flaps - 56 Series Catalogue Number 56SOLOCK Suits all products equipped with flap.



Alkaline - Clipsal 56 Series						
Catalogue Number	Description	Number of switched poles	I_{the} (Amp)	Ui/Ue (Volt)	Cond. Term Size in mm ²	Colour
					Min/Max /Cond.	
56SWAUX15	Auxiliary Switch - 56 Series	1P	15	250	(1.5,6)	-
56LEDK1	Single Phase Red LED	-	Up to 63	250	-	red
56LEDK3	Three Phase Red, White, Blue LED	-	Up to 63	250 / 415	-	red, blue, white
56SOLOCK	Lock for Socket Flaps - 56 Series	-	-	-	-	-
56SOAUX15	Auxiliary Switch - 56 Series	-	15	250	(1.5,6)	-

Plug, Extension Socket, and Appliance Connector Accessories

The 56 series 56SHM and 56SHL Suspension Hooks enable three-phase 56CSC Series Industrial Connectors to be easily converted to pendant outlets.

There are two models available (medium 56SHM and large 56SHL) for connectors; 10 A - 20 A and 32 A - 50 A respectively, both of which are manufactured from quality 316 grade stainless steel for long life and to withstand loads of up to 50 kg.

The stainless steel 56SPOK suspended outlet kit allows two 56C or 56CV Series to be mounted back to back. It is also supplied with 316 grade stainless steel mounting screws.

When not in use, 56P and 56PA Series Plugs can be additionally protected by utilising the 56PC Series Plug Caps. This includes the 56PC, 56PCI, and 56PC2 caps. When in position, they protect the pins from damage, dirt, grease, chemicals, and water ingress. The caps are simple to fit and fully enclose the plug face to provide IP66 protection. The 56 Series Single Phase CSC Extension Sockets and Appliance Connectors can be additionally protected by utilising the 56SC2 Socket Cap.

The 56AM25 + 56AM40 threaded adaptors are suitable for fitments of flexible conduit glands or hose adaptors. To fit, simply remove existing locknut and replace with adaptor module.

- 56AM25 suits 10 A to 20 A three-phase plugs

- 56AM40 suits 32 A to 50 A three- phase plugs



Alkaline - Clipsal 56 Series			
Catalogue Number	Description	Compatibility	Colour
56PC2-RO	56 Series Plug Cap	single-phase (but not size 1 plugs)	Orange
56PCI-TR	56 Series Plug Cap	3 Phase 32 A + single-phase round pin	Clear
56PC-TR	56 Series Plug Cap	3 Phase 10 A - 20 A + 20 A single-phase round pin	Clear
56SC2-RO	56 Series Socket Connector Cap	[10A,15A] 1P Plugs	Orange
56SHL	56 Series Suspension Hook - Large	3 Phase 32 A - 50 A	-
56AM25	56 Series Adapter Module - 25 mm	10 A - 20 A Size 1	Orange
56AM40	56 Series Adapter Module - 40 mm	32 A - 50 A Size 2	Orange
56POK	56 Series Pendant Outlet Kit - 3 Phase - 10/20 A	10 A - 20 A Size 1	-
56POKI	56 Series Pendant Outlet Kit - 3 Phase - 32/50 A	32 A - 50 A Size 2	-

Dimensions (mm)

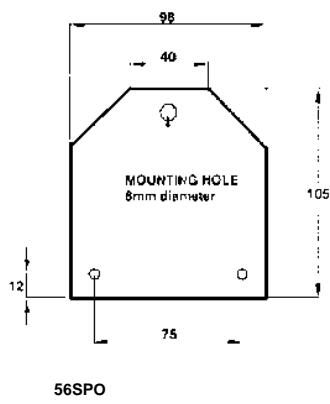

56SPOK

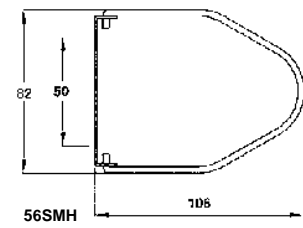
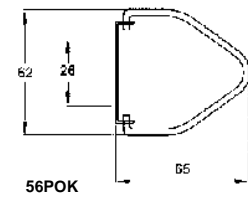
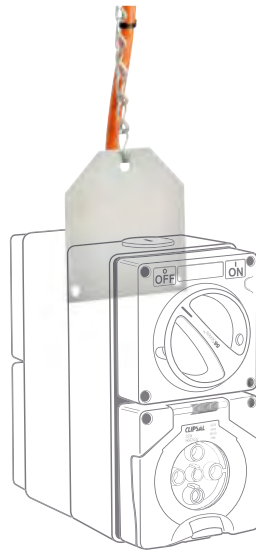

Mounting Enclosure (Back Box) Accessories

Condensation drain, catalogue number 56D, should be used when condensation build up is a problem. The 56D is made from chemically resistant nylon and comes complete with lock nut.

Note: Installation of the 56D de-rates the product to IP54.

The 56 Series 1 Gang Gasket Catalogue Number 56G1 - Replacement single gang gasket. Rated IP66.

56 Series 2 Gang Gasket Catalogue Number 56G2 - Replacement double gang gasket.

Catalogue Number 56MF - Mounting feet and stainless steel mounting screws (1¼" x 10 gauge) are provided to space 56 Series accessories off walls used in food industries. The 56MF is designed to be used in conjunction with food industry 280MC Mounting Channels and 280 Series 25 mm Conduit Clips.

Catalogue No. 56PMK - A heavy-duty stainless steel pole mounting kit made of 316 Grade stainless steel. Comes complete with ¾" and 1¼" size stainless steel mounting screws.

The unique 56 Series High Pressure Gaskets are specifically designed where hygiene is paramount (dairies, abattoirs). These areas are most commonly cleaned using a 75 °C, 1600 psi, 25 l/min, high pressure cleaning gun with chemical cleaner added. The 56 Series High Pressure Gaskets are suited to these environments and are compatible with 56E1, 56E2, and 56E4 enclosures.

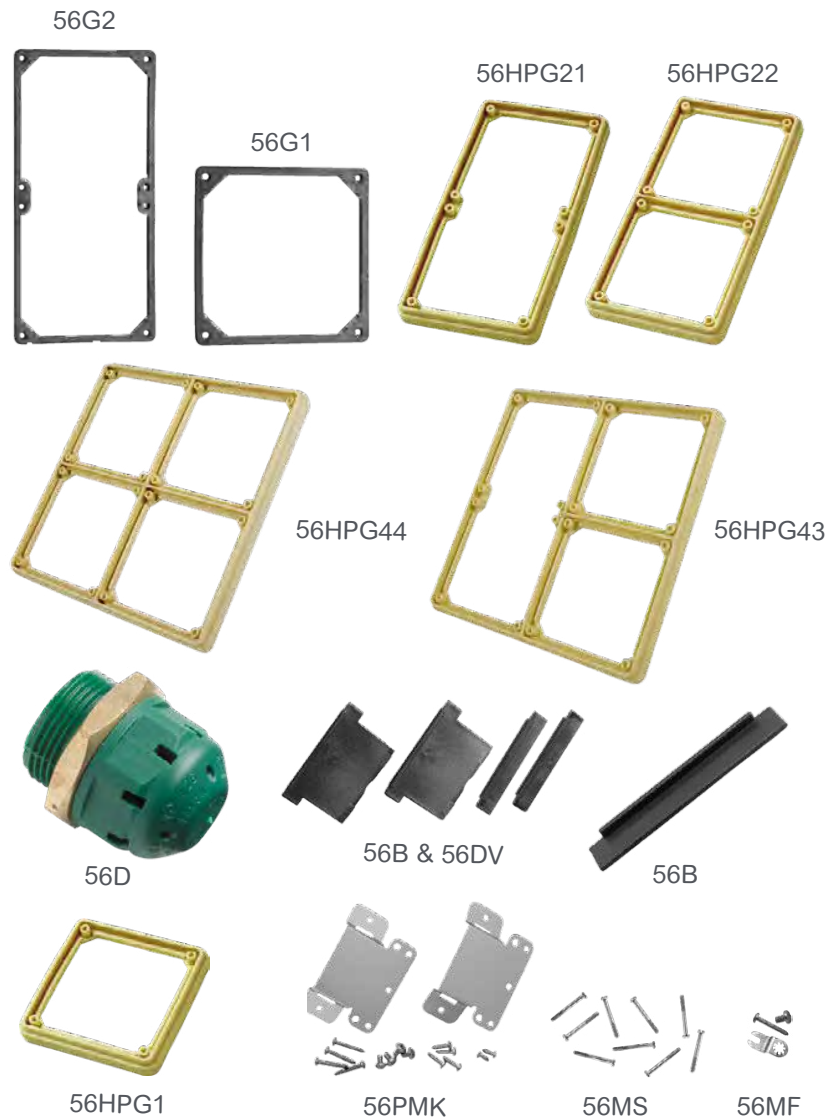

Alkaline - Clipsal 56 Series

Catalogue Number	Number of Gangs	Description	Colour
56HPG1-CM	1	56 Series High Pressure Gasket - 1 Gang	Cream
56HPG2/1-CM	2	56 Series High Pressure Gasket - 2 Gang	Cream
56HPG2/2-CM	2 x 1 Gang	56 Series High Pressure Gasket - 2 x1 Gang	Cream
56HPG4/3-CM	2 x 1 Gang, 1 x 2 Gang	56 Series High Pressure Gasket - 2 x1 Gang - 1 x 2 Gang	Cream
56HPG4/4-CM	4 x 1 Gang	56 Series High Pressure Gasket - 4 x 1 Gang	Cream
56G1	1	56 Series Gasket - 1 Gang	Black
56G2	2	56 Series Gasket - 2 Gang	Black
56MF	-	56 Series Mounting Feet	Stainless Steel
56MS	-	56 Series Cover Screws	Stainless Steel
56PMK	-	56 Series Pole Mounting Kit	Stainless Steel
56D	-	Condensation Drain	Green
56/4CB	-	56 series DIN rail assembly	-
56B-BK	-	56 series enclosure bridge	Black
56DV-BK	-	57 series enclosure divider	Black

Flush Surrounds

Surface mounted 56 Series Sockets, Switches, and Combinations can be transformed into flush mounting equivalents using the 56FA Surrounds and Brackets. The Surrounds can be used on various types of walls to provide a neat installation, such as:

- a mounting enclosure (back box) in poured concrete.
- a bracket on brick, brick veneer, or panel walls.

The brackets provide the installer with a practical method of flush mounting 56 Series accessories. Comprehensive installation instructions are supplied with all units. The 56FA1, 56FA2, 56FA3, and 56FA4 Flush Surrounds contain a moulded flange, foam gasket, and stainless steel mounting screws. The 56FA1B, 56FA2B, 56FA3B, and 56FA4B Flush Surrounds contain a corrosion resistant steel mounting metal bracket.



Alkaline - Clipsal 56 Series

Catalogue Number	No. of Gangs	Description	O/A Dimensions					Colour
			(A)	(B)	(C)	(D)	(E)	
56FA1B	1	56 Series Flush Surround - Base- 1 Gang	141	141	0	82	-	-
56FA1-CG	1	56 Series Flush Surround - 1 Gang	157	157	13	97	-	Chemical Grey
56FA2B	2	56 Series Flush Surround - Base- 2 Gang	141	242	0	82	179	-
56FA2-WW	2	56 Series Flush Surround - 2 Gang	157	254	13	97	194	Dark Grey
56FA3B	3	56 Series Flush Surround - Base- 3 Gang	141	338	0	82	275	-
56FA3-CG	3	56 Series Flush Surround - 3 Gang	157	350	13	97	281	Chemical Grey
56FA3-WW	3	56 Series Flush Surround - 3 Gang	157	350	13	97	281	Dark Grey
56FA4B	4	56 Series Flush Surround - Base- 4 Gang	242	242	0	179	179	-
56FA4-WW	4	56 Series Flush Surround - 4 Gang	254	254	13	184	184	Dark Grey

Dimensions (mm)

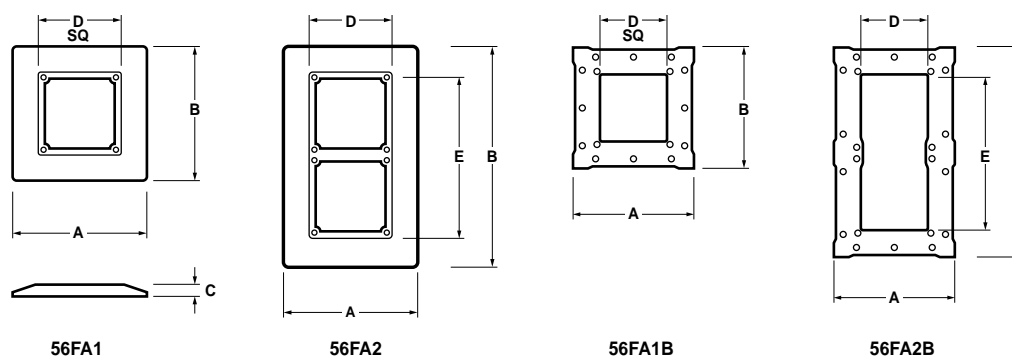

Surface Socket Spare Parts

A range of replacement internal socket housings are available for 3 phase 56SO models. No need to replace an entire unit if only the internal socket housing is damaged. Socket terminal housings are moulded in durable polyester.



Alkaline - Clipsal 56 Series



Catalogue Number	I_{the} (Amp)	Ui/Ue (Volt)	Type of socket	Cond. Term Size in mm ²
				Min/Max /Cond.
56SO320G	20	250	1P + N + E	[2,5,6]
56SO332G	32	250	1P + N + E	[6,16]
56SO520G	20	500	3P + N + E	[2,5,6]
56SO550G	50	500	3P + N + E	[10,16]

Technical Guide

Chemical Resistance Guide					
Chemical type	All Mounting Enclosures	Grey (GY) Transparent Covers	Resistant Orange (RO) Resistant White (RW) Covers	Chemical Grey (CG) Covers	Plugs
Acids					
Hydrochloric 10%	R	R	R	R	R
Nitric 10%	R	LR	R	R	LR
Acetic acid 10%	R	R	R	LR	LR
Sulphuric 100%	R	LR	R	LR	LR
Alkalis					
Sodium hydroxide 10% (Caustic soda)	R	NR	LR	R	LR
Potassium hydroxide 100%	LR	NR	NR	R	LR
Sanitising solutions					
Chlorinated alkaline foaming cleaner 10%	R	NR	NR	R	LR
Ammonium sanitiser	R	NR	NR	R	LR
Vegetable oils					
Olive oil	R	NR	NR	R	LR
Canola oil	R	NR	NR	R	LR
Solvents					
Methane	LR	R	R	-	R
Propane	R	R	R	-	R
Ethylene glycol	R	R	R	-	R
Glycerol (Glycerine)	R	LR	LR	R	R
Methyl alcohol (Methanol)	R	R	R	LR	R
Ethyl alcohol (Ethanol)	R	R	R	NR	R
Aniline	NR	NR	NR	NR	LR
Methyl benzene	NR	NR	LR	NR	LR
Xylene	NR	NR	LR	NR	LR
Dimethyl ethyl	R	R	R	-	R
Acetone	R	LR	LR	LR	LR
Acetophenone	NR	NR	LR	NR	LR
Ethyl methyl ketone	NR	NR	LR	NR	R
Isopropyl Alcohol	-	R	R	NR	R

Chemical Resistance Guide					
Chemical type	All Mounting Enclosures	Grey (GY) Transparent Covers	Resistant Orange (RO) Resistant White (RW) Covers	Chemical Grey (CG) Covers	Plugs
Automotive					
Unleaded Petroleum	R	NR	NR	R	LR
Diesel	-	R	R	NR	LR
Brake Fluid	-	NR	NR	NR	LR
Grease at 60 °C (Rocol 12475)	-	LR	LR	-	-
Grease at 60°C (Rocol Sapphire Hi Temp)	-	LR	LR	-	-
Lubricating oil (10w/40)	-	-	-	-	R
Hydraulic oil (Hf-105L)	-	-	-	-	R
Oxidising agents					
Sodium hypochlorite 5%	R	R	R	R	LR
Hydrogen peroxide 30%	R	R	R	R	LR
Water					
Ambient	R	R	R	R	R
Hot > 60 °C	R	R	R	R	LR
Miscellaneous					
Detergent @ 50 °C	R	LR	NR	R	LR
Magnesium sulphate	R	R	R	-	R
Salts					
Calcium Chloride 10%	R	R	R	R	LR
Sodium Chloride 5%	R	R	R	R	R
Ammonium Hydroxide 100%	R	R	R	R	R

This table should be used as a guide only. The end user should evaluate the suitability of any chemical with any plastic.

Resistant  Limited Resistance  Not Resistant 

When products are required to use in environments with high concentrations of acids, bases, or oils, it is recommended to contact your local Schneider Electric office for support.

Technical Guide

Industrial Application Matrix

 Retail and wholesale trade buildings			
Supermarket (Coles, Woolies etc)	<ul style="list-style-type: none"> Plant Rooms Pedestrian Traffic Areas Staff Lunchroom Cool Room For Perishable Storage 	<ul style="list-style-type: none"> Staff Or Public Car Park Toilets / Wet Areas Office Food Preparation Area / Kitchen 	<ul style="list-style-type: none"> Rooftop Plant Platforms Outdoor Lighting Public Eating Area
Department Store	<ul style="list-style-type: none"> Plant Rooms Pedestrian Traffic Areas Staff Lunchroom Public Eating Area 	<ul style="list-style-type: none"> Warehouse Staff Or Public Car Park Toilets / Wet Areas 	<ul style="list-style-type: none"> Office Outdoor Lighting Rooftop Plant Platforms
Shopping Centre	<ul style="list-style-type: none"> Plant Rooms Pedestrian Traffic Areas Staff Lunchroom Public Eating Area 	<ul style="list-style-type: none"> Staff or Public Car Park Toilets / Wet Areas Office 	<ul style="list-style-type: none"> Food Preparation Area / Kitchen Rooftop Plant Platforms Outdoor Lighting
Outdoor Mall	<ul style="list-style-type: none"> Plant Rooms Pedestrian Traffic Areas Staff Lunchroom 	<ul style="list-style-type: none"> Public Eating Area Staff Or Public Car Park Toilets / Wet Areas 	<ul style="list-style-type: none"> Office Outdoor Lighting Rooftop Plant Platforms
Fast Food Outlet (McD's, KFC, Chicken / Fish & Chip, etc)	<ul style="list-style-type: none"> Public Eating Area Cool Room for Perishable Storage Exposure to Detergents Exposure to Acids / Citrus Based Cleaners 	<ul style="list-style-type: none"> Exposure to Cooking Oil Staff or Public Car Park Toilets / Wet Areas Office 	<ul style="list-style-type: none"> Food Preparation Area / Kitchen Rooftop Plant Platforms Outdoor Lighting Plant Rooms
Restaurants / Caf�es / Bakery / Commercial Kitchen / Mobile Food Vans	<ul style="list-style-type: none"> Public Eating Area Cool Room for Perishable Storage Exposure to Detergents Exposure to Acids / Citrus Based Cleaners 	<ul style="list-style-type: none"> Exposure to Cooking Oil Staff or Public Car Park Toilets / Wet Areas Office 	<ul style="list-style-type: none"> Food Preparation Area / Kitchen Rooftop Plant Platforms Outdoor Lighting Plant Rooms
Butchers	<ul style="list-style-type: none"> Pedestrian Traffic Areas Cool Room for Perishable Storage Exposure to Alkali's 	<ul style="list-style-type: none"> Toilets / Wet Areas Food Preparation Area / Kitchen Outdoor Lighting 	<ul style="list-style-type: none"> Staff Lunchroom Staff or Public Car Park Office
Car Wash	<ul style="list-style-type: none"> Plant Rooms, Pedestrian Traffic Areas Exposure to Detergents Toilets / Wet Areas 	<ul style="list-style-type: none"> Food Preparation Area / Kitchen Outdoor Lighting Staff Lunchroom 	<ul style="list-style-type: none"> Staff or Public Car Park Office Rooftop Plant Platforms
Petrol Stations / Garage	<ul style="list-style-type: none"> Maintenance Workshop Staff or Public Car Park Toilets / Wet Areas Outdoor Lighting 	<ul style="list-style-type: none"> Plant Rooms, Pedestrian Traffic Areas Staff Lunchroom Public Eating Area Exposure to Detergents 	<ul style="list-style-type: none"> Exposure to Cooking Oil Office Food Preparation Area / Kitchen Rooftop Plant Platforms
Generator or Hire Equipment (mobile fridges, scissor lifts, etc)	<ul style="list-style-type: none"> Maintenance Workshop Pedestrian Traffic Areas Staff Lunchroom Despatch / Vehicle Loading / Transport Area 	<ul style="list-style-type: none"> Staff or Public Car Park Toilets / Wet Areas Office Outdoor Lighting 	<ul style="list-style-type: none"> Plant Rooms Exposure to Detergents Rooftop Plant Platforms

Transport buildings

Transport Depot freight (road / rail / water) air	<ul style="list-style-type: none"> Staff Lunchroom Despatch / Vehicle Loading / Transport Area Staff or Public Car Park 	<ul style="list-style-type: none"> Toilets / Wet Areas Office Outdoor Lighting 	<ul style="list-style-type: none"> Maintenance Workshop Plant Rooms Rooftop Plant Platforms
Transport Depot passenger (road / rail / water) air	<ul style="list-style-type: none"> Pedestrian Traffic Areas Staff Lunchroom Despatch / Vehicle Loading / Transport Area Staff Or Public Car Park 	<ul style="list-style-type: none"> Toilets / Wet Areas Office Outdoor Lighting Plant Rooms 	<ul style="list-style-type: none"> Public Eating Area Food Preparation Area / Kitchen Rooftop Plant Platforms

Industrial Application Matrix

Marina / Jetties	<ul style="list-style-type: none"> • Pedestrian Traffic Areas • Staff or Public Car Park • Toilets / Wet Areas • Office 	<ul style="list-style-type: none"> • Boat Washdown • Outdoor Lighting • Food Preparation Area / Kitchen 	<ul style="list-style-type: none"> • Rooftop Plant Platforms • Conveyor Belt • Outdoor Bbq's
Car Parks	<ul style="list-style-type: none"> • Plant Rooms • Pedestrian Traffic Areas • Staff or Public Car Park 	<ul style="list-style-type: none"> • Office • Outdoor Lighting 	<ul style="list-style-type: none"> • Toilets / Wet Areas • Rooftop Plant Platforms



Offices

Office Buildings	<ul style="list-style-type: none"> • Staff lunchroom • Staff or public car park • Toilets / wet areas • Office 	<ul style="list-style-type: none"> • Rooftop plant platforms • Plant rooms • Pedestrian traffic areas 	
------------------	--	--	--



Commercial buildings n.e.c.

Fire Station	<ul style="list-style-type: none"> • Staff lunchroom • Exposure to detergents • Staff or public car park • Toilets / wet areas 	<ul style="list-style-type: none"> • Office • Outdoor lighting • Plant rooms • Rooftop plant platforms 	
Court House	<ul style="list-style-type: none"> • Staff lunchroom • Staff or public car park • Toilets / wet areas • Office 	<ul style="list-style-type: none"> • Outdoor lighting • Plant rooms • Rooftop plant platforms 	
Police station / Gaols / Detention centres	<ul style="list-style-type: none"> • Staff lunchroom • Staff or public car park • Toilets / wet areas 	<ul style="list-style-type: none"> • Office • Outdoor lighting • Plant rooms 	<ul style="list-style-type: none"> • Exposure to detergents • Food preparation area / kitchen • Rooftop plant platforms



Factories and other secondary production buildings

Assembly Plant (CHCH, GX etc)	<ul style="list-style-type: none"> • Staff lunchroom • Warehouse • Assembly plant / fabrication area • despatch / vehicle loading / transport area 	<ul style="list-style-type: none"> • Staff or public car park • Toilets / wet areas • Office • Rooftop plant platforms 	<ul style="list-style-type: none"> • Tool room or general fabrication workshop • Plant rooms • Cool room for perishable storage • Conveyor belt
Dairy / Abattoir / Food (Inghams, Fonterra, Thomas Foods etc)	<ul style="list-style-type: none"> • Plant rooms • Staff lunchroom • Cool room for perishable storage • Warehouse • Exposure to alkali's 	<ul style="list-style-type: none"> • Exposure to detergents • Despatch / vehicle loading / transport area • Staff or public car park • Toilets / wet areas 	<ul style="list-style-type: none"> • Office • Rooftop plant platforms • Maintenance workshop • Conveyor belt
Foundry (Glass producer, cast metal production)	<ul style="list-style-type: none"> • Staff lunchroom • Warehouse • Minerals processing / furnaces • despatch / vehicle loading / transport area • Staff or public car park 	<ul style="list-style-type: none"> • Toilets / wet areas • Office • Tool room or general fabrication workshop 	<ul style="list-style-type: none"> • Plant rooms • Rooftop plant platforms • Conveyor belt
Chemical Plant	<ul style="list-style-type: none"> • Plant rooms • Staff lunchroom • Warehouse • Despatch / vehicle loading / transport area • staff or public car park • Toilets / wet areas 	<ul style="list-style-type: none"> • Office • Maintenance workshop • Tool room or general fabrication workshop • Exposure to alkali's • Exposure to detergents 	<ul style="list-style-type: none"> • Exposure to acids / citrus based cleaners • Minerals processing / furnaces • Outdoor storage tanks / ponds / silos • Rooftop plant platforms • Bottling plant • Conveyor belt

Industrial Application Matrix

Minerals processing (mining site or secondary production plant)	<ul style="list-style-type: none"> Plant rooms Staff lunchroom Warehouse Minerals processing / furnaces Despatch / vehicle loading / transport area Staff or public car park Toilets / wet areas 	<ul style="list-style-type: none"> Office Maintenance workshop Tool room or general fabrication workshop Cool room for perishable storage Exposure to alkali's Exposure to detergents 	<ul style="list-style-type: none"> Exposure to acids / citrus based cleaners Outdoor storage tanks / ponds / silos Rooftop plant platforms Bottling plant Conveyor belt
General Fabricator	<ul style="list-style-type: none"> Maintenance workshop Tool room or general fabrication workshop Staff lunchroom Staff or public car park Toilets / wet areas 	<ul style="list-style-type: none"> Office Plant rooms Warehouse Assembly plant / fabrication area Exposure to detergents 	<ul style="list-style-type: none"> Exposure to acids / citrus based cleaners Despatch / vehicle loading / transport area Rooftop plant platforms
Winery, Brewery, Distillery	<ul style="list-style-type: none"> Staff lunchroom Cool room for perishable storage Warehouse Outdoor storage tanks / ponds / silos Despatch / vehicle loading / transport area Staff or public car park Toilets / wet areas 	<ul style="list-style-type: none"> Office Bottling plant Maintenance workshop Plant rooms Pedestrian traffic areas Public eating area Exposure to detergents 	<ul style="list-style-type: none"> Exposure to acids / citrus based cleaners Bottle / vat sterilising Food preparation area / kitchen Rooftop plant platforms Conveyor belt
Cabinet Maker / Spray Painter	<ul style="list-style-type: none"> Maintenance workshop Staff lunchroom Staff or public car park Toilets / wet areas Office 	<ul style="list-style-type: none"> Assembly plant / fabrication area Despatch / vehicle loading / transport area Rooftop plant platforms 	
Motor / Rail body builder	<ul style="list-style-type: none"> Maintenance workshop Staff lunchroom Staff or public car park Toilets / wet areas 	<ul style="list-style-type: none"> Office Tool room or general fabrication workshop Plant rooms 	<ul style="list-style-type: none"> Assembly plant / fabrication area Despatch / vehicle loading / transport area Rooftop plant platforms



Warehouses / Distribution Centres

Refrigerated Storage (Perishables such as food & beverage)	<ul style="list-style-type: none"> Plant rooms Staff lunchroom Cool room for perishable storage Despatch / vehicle loading / transport area 	<ul style="list-style-type: none"> Staff or public car park Toilets / wet areas Office Maintenance workshop 	<ul style="list-style-type: none"> Tool room or general fabrication workshop Warehouse Rooftop plant platforms
General Storage (non-perishable items)	<ul style="list-style-type: none"> Staff lunchroom Despatch / vehicle loading / transport area Staff or public car park Toilets / wet areas 	<ul style="list-style-type: none"> Office Maintenance workshop Tool room or general fabrication workshop 	<ul style="list-style-type: none"> Plant rooms Cool room for perishable storage Warehouse Rooftop plant platforms



Agricultural and aquacultural buildings

Farm Out Buildings (Barns, shearing sheds etc)	<ul style="list-style-type: none"> Maintenance workshop 		
Primary production (milking shed)	<ul style="list-style-type: none"> Despatch / vehicle loading / transport area Office Maintenance workshop Plant rooms Cool room for perishable storage 	<ul style="list-style-type: none"> Exposure to alkali's Exposure to detergents Outdoor storage tanks / ponds / silos Staff or public car park Toilets / wet areas 	
Aquaculture / Fish Farms	<ul style="list-style-type: none"> Staff lunchroom Warehouse Minerals processing / furnaces despatch / vehicle loading / transport area Staff or public car park 	<ul style="list-style-type: none"> Toilets / wet areas Office Tool room or general fabrication workshop 	<ul style="list-style-type: none"> Plant rooms Rooftop plant platforms Conveyor belt
Wheat Silo / Storage	<ul style="list-style-type: none"> Plant rooms Staff lunchroom Warehouse Despatch / vehicle loading / transport area staff or public car park Toilets / wet areas 	<ul style="list-style-type: none"> Office Maintenance workshop Tool room or general fabrication workshop Exposure to alkali's Exposure to detergents 	<ul style="list-style-type: none"> Exposure to acids / citrus based cleaners Minerals processing / furnaces Outdoor storage tanks / ponds / silos Rooftop plant platforms Bottling plant Conveyor belt

Industrial Application Matrix

 Other industrial buildings n.e.c.			
Electrical generation	<ul style="list-style-type: none"> Maintenance workshop Staff lunchroom Staff or public car park Toilets / wet areas 	<ul style="list-style-type: none"> Office Tool room or general fabrication workshop Plant rooms 	<ul style="list-style-type: none"> Rooftop plant platforms Outdoor lighting
Water Treatment (reservoir etc)	<ul style="list-style-type: none"> Maintenance workshop Staff lunchroom Outdoor storage tanks / ponds / silos Staff or public car park Toilets / wet areas 	<ul style="list-style-type: none"> Office Tool room or general fabrication workshop Plant rooms Pedestrian traffic areas 	<ul style="list-style-type: none"> Exposure to detergents Exposure to acids / citrus based cleaners Rooftop plant platforms Outdoor lighting
Waste Water Treatment	<ul style="list-style-type: none"> Maintenance workshop Staff lunchroom Outdoor storage tanks / ponds / silos Staff or public car park Toilets / wet areas 	<ul style="list-style-type: none"> Office Tool room or general fabrication workshop Plant rooms Pedestrian traffic areas 	<ul style="list-style-type: none"> Exposure to detergents Exposure to acids / citrus based cleaners Rooftop plant platforms Outdoor lighting

 Education buildings			
School / University	<ul style="list-style-type: none"> Pedestrian traffic areas Staff lunchroom Public eating area Cool room for perishable storage Warehouse 	<ul style="list-style-type: none"> Staff or public car park Toilets / wet areas Office Food preparation area / kitchen Rooftop plant platforms 	<ul style="list-style-type: none"> Maintenance workshop Plant rooms Exposure to cooking oil Swimming pool / growing pond Outdoor lighting
Boarding / Accomodation	<ul style="list-style-type: none"> Pedestrian traffic areas Staff lunchroom Public eating area Cool room for perishable storage 	<ul style="list-style-type: none"> Staff or public car park Toilets / wet areas Office Food preparation area / kitchen 	<ul style="list-style-type: none"> Rooftop plant platforms Plant rooms Swimming pool / growing pond Outdoor lighting

 Religion buildings			
Places of Worship (churches etc)	<ul style="list-style-type: none"> Pedestrian traffic areas Staff or public car park Toilets / wet areas Public eating area 	<ul style="list-style-type: none"> Cool room for perishable storage Exposure to cooking oil Office Food preparation area / kitchen 	<ul style="list-style-type: none"> Rooftop plant platforms Outdoor lighting

 Aged care facilities			
Aged Care / Nursing Home	<ul style="list-style-type: none"> Pedestrian traffic areas Staff lunchroom Public eating area Cool room for perishable storage Staff or public car park 	<ul style="list-style-type: none"> Toilets / wet areas Office Food preparation area / kitchen Maintenance workshop 	<ul style="list-style-type: none"> Plant rooms Exposure to cooking oil Swimming pool / growing pond Outdoor lighting

 Health buildings			
Hospital	<ul style="list-style-type: none"> Maintenance workshop Plant rooms Pedestrian traffic areas Staff lunchroom Public eating area 	<ul style="list-style-type: none"> Cool room for perishable storage Despatch / vehicle loading / transport area Staff or public car park Toilets / wet areas 	<ul style="list-style-type: none"> Office Food preparation area / kitchen Rooftop plant platforms Swimming pool / growing pond
GP Clinic / Dentist	<ul style="list-style-type: none"> Staff lunchroom Exposure to detergents Staff or public car park 	<ul style="list-style-type: none"> Office Toilets / wet areas 	<ul style="list-style-type: none"> Cool room for perishable storage Rooftop plant platforms
Radiographer / Pathologist	<ul style="list-style-type: none"> Staff lunchroom Exposure to detergents Staff or public car park 	<ul style="list-style-type: none"> Office Toilets / wet areas 	<ul style="list-style-type: none"> Cool room for perishable storage Rooftop plant platforms
Laboratories	<ul style="list-style-type: none"> Staff lunchroom Exposure to detergents Staff or public car park 	<ul style="list-style-type: none"> Office Toilets / wet areas 	<ul style="list-style-type: none"> Cool room for perishable storage Rooftop plant platforms

Industrial Application Matrix







 Entertainment and recreation buildings			
Oval / Arena	<ul style="list-style-type: none"> • Pedestrian traffic areas • Staff lunchroom • Public eating area • Cool room for perishable storage • Staff or public car park 	<ul style="list-style-type: none"> • Toilets / wet areas • Office • Food preparation area / kitchen • Maintenance workshop 	<ul style="list-style-type: none"> • Plant rooms • Exposure to cooking oil • Rooftop plant platforms • Outdoor lighting
Gym / Tennis Centre	<ul style="list-style-type: none"> • Pedestrian traffic areas • Staff lunchroom • Public eating area • Cool room for perishable storage • Staff or public car park 	<ul style="list-style-type: none"> • Toilets / wet areas • Office • Food preparation area / kitchen • Maintenance workshop 	<ul style="list-style-type: none"> • Plant rooms • Exposure to cooking oil • Rooftop plant platforms • Outdoor lighting
Entertainment Centre / Theater / Cinema	<ul style="list-style-type: none"> • Pedestrian traffic areas • Staff lunchroom • Public eating area • Cool room for perishable storage • Staff or public car park 	<ul style="list-style-type: none"> • Toilets / wet areas • Office • Food preparation area / kitchen • Maintenance workshop 	<ul style="list-style-type: none"> • Plant rooms • Exposure to cooking oil • Rooftop plant platforms • Outdoor lighting
Aquatic centre (swimming pools, aquariums etc)	<ul style="list-style-type: none"> • Pedestrian traffic areas • Staff lunchroom • Public eating area • Cool room for perishable storage • Staff or public car park 	<ul style="list-style-type: none"> • Toilets / wet areas • Office • Food preparation area / kitchen • Maintenance workshop 	<ul style="list-style-type: none"> • Plant rooms • Exposure to cooking oil • Rooftop plant platforms • Outdoor lighting
Libraries / Museums	<ul style="list-style-type: none"> • Pedestrian traffic areas • Staff lunchroom • Public eating area • Cool room for perishable storage • Staff or public car park 	<ul style="list-style-type: none"> • Toilets / wet areas • Office • Food preparation area / kitchen • Maintenance workshop 	<ul style="list-style-type: none"> • Plant rooms • Exposure to cooking oil • Rooftop plant platforms • Outdoor lighting
Casino	<ul style="list-style-type: none"> • Pedestrian traffic areas • Staff lunchroom • Public eating area • Cool room for perishable storage • Staff or public car park 	<ul style="list-style-type: none"> • Toilets / wet areas • Office • Food preparation area / kitchen • Maintenance workshop 	<ul style="list-style-type: none"> • Plant rooms • Exposure to cooking oil • Rooftop plant platforms • Outdoor lighting
Public Parks / Beaches	<ul style="list-style-type: none"> • Pedestrian traffic areas • Toilets / wet areas • Outdoor bbq's 	<ul style="list-style-type: none"> • Outdoor lighting • Public eating area • Staff or public car park 	

 Short term accommodation buildings			
Hotel	<ul style="list-style-type: none"> • Plant rooms • Pedestrian traffic areas • Staff lunchroom • Public eating area • Cool room for perishable storage 	<ul style="list-style-type: none"> • Staff or public car park • Toilets / wet areas • Office • Food preparation area / kitchen 	<ul style="list-style-type: none"> • Maintenance workshop • Exposure to cooking oil • Rooftop plant platforms • Swimming pool / growing pond
Serviced Apartments	<ul style="list-style-type: none"> • Plant rooms • Pedestrian traffic areas • Staff lunchroom • Staff or public car park 	<ul style="list-style-type: none"> • Toilets / wet areas • Office • Maintenance workshop • Cool room for perishable storage 	<ul style="list-style-type: none"> • Exposure to cooking oil • Rooftop plant platforms • Swimming pool / growing pond

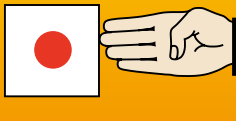
 Other non-residential n.e.c.			
Data Centre	<ul style="list-style-type: none"> • Plant rooms • Staff lunchroom • Staff or public car park • Toilets / wet areas • Office • Rooftop plant platforms 		

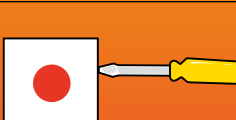
International Protection Ratings



Protection against solids

	TEST	PROTECTION
x	No test applied	No specific protection
0	No test applied	Inherent degree of protection
1		Protected against solid objects equal to or greater than 50 mm diameter. (eg. accidental contact with hand)
2		Protected against solid objects equal to or greater than 12.5mm diameter. (eg. contact with finger)
3		Protected against solid objects equal to or greater than 2.5mm diameter. (eg. tools and wires)
4		Protected against solid objects equal to or greater than 1mm diameter. (eg. fine tools and wires)
5		Protected against quantities of dust that could interfere with satisfactory operation.
6		Completely protected against dust.

Defined by IEC 60529
DIN 40050 CEI 70-1

To Australian standards AS 60529-2004
Degrees of protection provided by enclosures.
(IP Code)

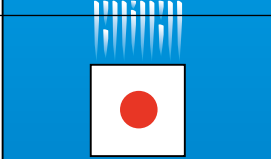
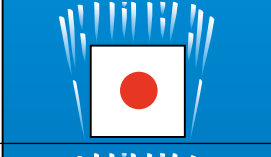
Protection against liquids

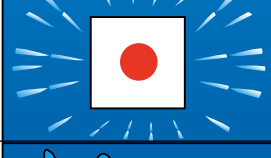
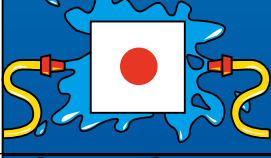
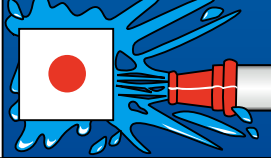
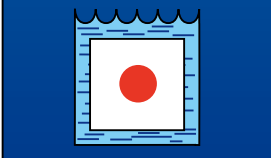
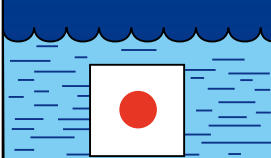
	TEST	PROTECTION
x	No test applied	No specific protection
0	No test applied	Inherent degree of protection
1		Protected against drops of water falling vertically.
2		Protected against drops of water falling at up to 15 degrees from the vertical.
3		Protected against spraying water at up to 60 degrees from the vertical.
4		Protected against splashing water from all directions.
5		Protected against jets of water from all directions.
6		Protected against jets of water of similar force to heavy seas.
7		Protected against the effects of temporary immersion.
8		Protected against the effects of continuous immersion.

Defined by IEC 60529

Technical Terms

The following technical terms are brief descriptions indicating the tests involved to attain ratings. For further information refer to the standards indicated.

M-Rating (refer AS/NZS3133)

Clipsal switches and switched socket outlets are marked with an M-Rating. This indicates that these products have been tested and found suitable for switching locked rotor current.

In part, this test involves 50 operations, make and break of the nominated locked rotor current at 0.5 power factor lagging. The switch will not fail to interrupt the current or fail in any way electrically or mechanically.

AC-21 (refer AS/NZS3947)

Switching of resistive loads, including moderate overloads.

In part, this involves five make and break operations, at 1 ½ times rated current and 1.1 times rated voltage at 0.95 cos.

Additional mechanical no load and electrical endurance tests at rated current and voltage at 0.95 cos are conducted.

AC-22 (refer AS/NZS3947)

Switched of mixed resistive and inductive loads, including moderate overloads.

In part, this involves five make and break operations at three times rated current and 1.1 times rated voltage at 0.65 cos.

Additional mechanical no load and electrical endurance tests at rated current and voltage at 0.65 cos.

AC-23 (refer AS/NZS3947)

Switching of motor loads or highly inductive loads.

In part, this involves five make and break operations at:

10 times rated current make

1.1 times rated voltage make

0.35 cos

8 times rated current break

1.1 times rated voltage break

0.35 cos

Additional mechanical at no load and electrical endurance tests at rated current and voltage at 0.35 cos are conducted.

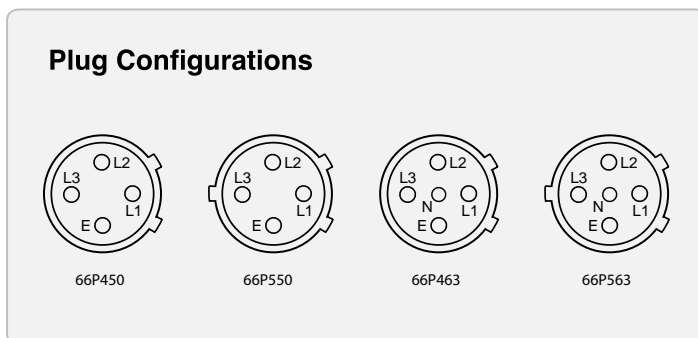

Plug and socket configuration

2 & 3 Pin



10A 250V
A



15A 250V
B



10A 250V
C



10A 110V
D



15A 32V
Polarised
E



20A 250V
F



10A 250V
G



20A 250V
H



32A 250V
I



10A 110V
J

4 Pin



10A 500V
K



20A 500V
L



16A 500V
(unique)
M



32A 500V
N



40A 500V
O



50A 500V
P



5 Pin

10A 500V
Q



20A 500V
R



32A 500V
S



40A 500V
T



50A 500V
U



6 Pin

10A 500V
V



7 Pin

10A 500V
W



20A 500V
X

2 & 3 Pin



10A 250V
A



15A 250V
B



10A 250V
C



10A 110V
D



15A 32V
Polarised
E



20A 250V
F



10A 250V
G



20A 250V
H



32A 250V
I



10A 110V
J



10A 500V
K



20A 500V
L



16A 500V
(unique)
M



32A 500V
N



40A 500V
O



50A 500V
P



10A 500V
Q



20A 500V
R



32A 500V
S



40A 500V
T



50A 500V
U



6 Pin

10A 500V
V



7 Pin

10A 500V
W



20A 500V
X

Schneider Electric (Australia) Pty. Ltd.
33-37 Port Wakefield Road,
Gepps Cross, South Australia, 5085
PO Box 132, Enfield Plaza,
South Australia, 5085
www.schneider-electric.com.au
998-21035829_AU-GB

Consumer Support Enquiries
Phone: 1300 669 925
Website: clipsal.com/contactus

National Customer Care (trade only)
Phone: 1300 369 233
Email: plugin@clipsal.com.au
©2020 Schneider Electric. All Rights
Reserved. Iconic and Clipsal Iconic
are trademarks of Schneider Electric
(Australia) PTY Limited.

clipsal.com

Life Is 

by Schneider Electric