

Control and Plug Adaptors

461SUA and 463SUA

Connection Instructions

461SUA Control Adaptor

This product is intended for use in conjunction with a control device. It is not a conventional plug-socket adaptor.

Safety Precautions

EARTH connection, if required.

An EARTH connection to the control adaptor is necessary only if the controlling device connected to the control adaptor requires to be EARTHED. (N.B. Any EARTHING from the appliance is maintained through adaptor EARTH pin).

If an EARTH connection is required, ensure EARTH wire with GREEN/YELLOW stripes (or all GREEN) is connected to the EARTH terminal marked "E" and with GREEN indication.

Ensure flexible cord and the controlling device are of correct ratings for all appliances intended to be controlled.

Applications

Recommended for 1mm² ordinary duty flexible cord. Adaptor may be wired for the following.

1. Double-pole and EARTH (5-core flex)
2. Double-pole without EARTH (4-core flex)
3. Single-pole and EARTH (3-core flex)
4. Single-pole without EARTH (2-core insulated and sheathed flex.)

NOTE: If wired as single-pole, connect together both "NEUTRAL" terminals with approximately 65mm overall single-insulated flexible cord jumper wire. Alternatively, this may possibly be achieved via a "NEUTRAL LOOPING" terminal, if available in the controlling device.

Stripping Dimensions (sketch actual size)

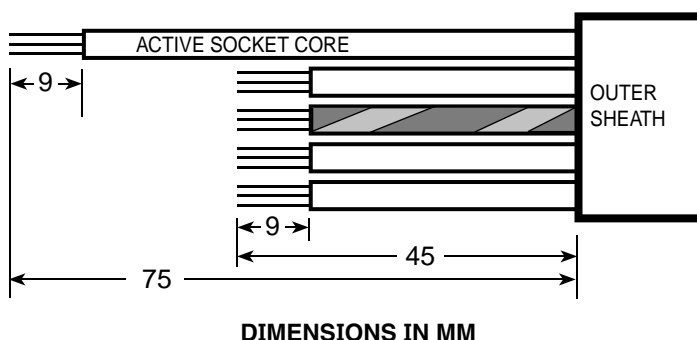

Wiring Instructions

For double-pole and EARTH applications:

1. Connect EARTH wire with GREEN/YELLOW stripes (or all GREEN) to EARTH terminal marked "E" and with GREEN indication.
2. Connect one "ACTIVE" wire to "A" plug-pin terminal in base.
3. Connect one "NEUTRAL" wire to "N" plug-pin terminal in base.
4. Connect other "ACTIVE" wire to "A" socket terminal in removable centre moulding.
5. Connect other "NEUTRAL" wire to "N" socket terminal in removable centre moulding.
6. Tuck wires from "E", "A" and "N" terminals in base, down into appropriate channels.
7. Tuck ACTIVE socket wire down through outside groove, back under moulding, up and over semi-circular boss, down to cable entry.
8. Tuck NEUTRAL socket wire down through outside groove to cable entry.
9. Double check that all wires are securely clamped and EARTH wire (if used) is connected to EARTH terminal.
10. Ensure outer sheathing of flexible cord enters 15mm into cable entry. Assemble cover and secure drive rivet.

463SUA Series 250V 10A Plug Adaptor

Recommended for 1mm² ordinary duty 3-core flexible cords

Stripping Dimensions (sketch actual size)

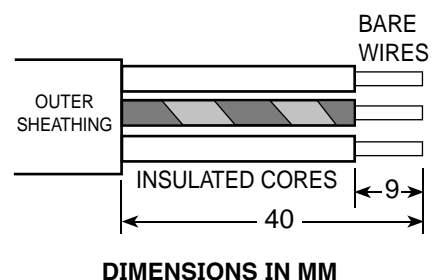

Safety Precautions

Ensure EARTH wire with GREEN/YELLOW stripes or all GREEN is connected to EARTH terminal marked "E" and with GREEN indication.

Wiring Instructions

NOTE: All connections to be made by clamping wires beneath top of fixed pins by moving nut.

Do not wrap wires under heads of screws.

1. Connect EARTH wire with GREEN/YELLOW stripe (or all GREEN) to EARTH terminal marked "E" and with GREEN indication

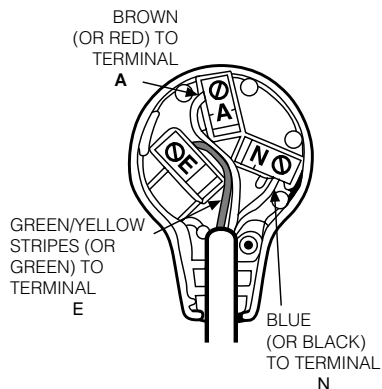

2. Connect BROWN (or RED) wire to ACTIVE terminal marked "A".
3. Connect BLUE (or BLACK) wire to NEUTRAL terminal marked "N".
4. Ensure that ACTIVE wire (BROWN or RED) is positioned underneath EARTH wire and that all wires are pushed down properly into respective recess.
5. Double check that EARTH wire is connected to EARTH terminal.
6. Push hard in and hold outer sheathing, it cover down neatly all round and ensure cover drive rivet is secured.

For further information regarding wiring and use of this control adaptor contact any Clipsal office.

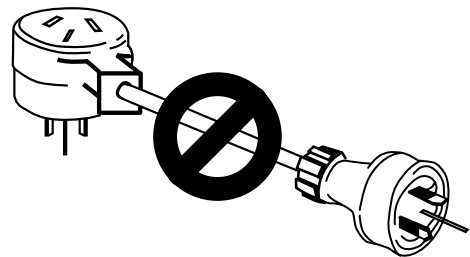
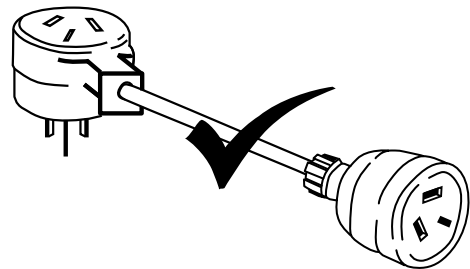
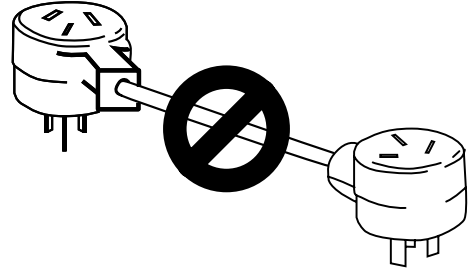
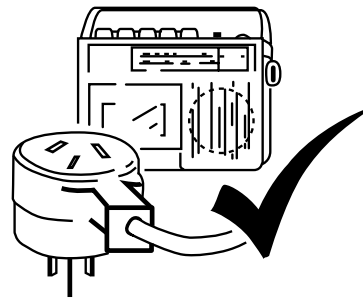

IMPORTANT SAFETY NOTICE

This product cannot be approved by Australian Electrical Authorities unless a flexible cord is attached.

Approval must be obtained for the complete assembly of adaptor and flexible cord.

Responsibility for approval is borne by the manufacturer of the complete assembly.

This adaptor MUST be permanently sealed with the drive rivet which is supplied in this carton.

NOTE: Australian Regulatory Authorities, as at "1st November 2000", will not approve rewirable socket adaptors.

Clipsal Australia Pty Ltd

A member of Schneider Electric

Contact us: clipsal.com feedback

National Customer Care Enquiries:

Tel **1300 2025 25** Fax **1300 2025 56**

clipsal.com

Clipsal Australia Pty Ltd reserves the right to change specifications, modify designs and discontinue items without incurring obligation and whilst every effort is made to ensure that descriptions, specifications and other information in this catalogue are correct, no warranty is given in respect thereof and the company shall not be liable for any error therein.

Clipsal Australia Pty Ltd. The identified trademarks and copyrights are the property of Clipsal Australia Pty Ltd unless otherwise noted.