

Installation materials

Fixing Accessories

Fixing solutions made for trade



Get your fix quick'n easy!



Make a green choice 100% halogen free fasteners

The electrical industry is seeking alternatives to the use of halogens for safety and environmental sustainability reasons.

In 2004, Schneider Electric decided to stop using flame retardants containing halogen.

Fixing Guide 4

Technical Information 6

Installation Material 6

Cavity Fixings 8

PLATTI™ TPP 8

DUO-MAX™ TSP 9

MONO-MAX™ TMM 10

Spring Toggle – TOG 11

Hollow Wall Anchor – TMX 12

Wallboard Anchor – DRIVA TPD 13

Masonry Fixings 14

High Performance Plugs – GREPI TPH 14

Nail Plugs – THI 15

Installation Screws – TMP-C3 16

Sleeve Anchors 17

Cable Management 18

Cable Wings 18

General Fasteners 19

Screws 19

Cable Clips, Pin Clips and Hand Tools 21

Fixing Guide

Suitable Structural Base Material						Max. Load Recommendation Shear* (13mm plasterboard)	Max. Load Recommendation Tension* (13mm plasterboard)	Your Fixing
Board materials	Solid concrete	Lightweight concrete	Solid Bricks	Hollow bricks/blocks	Stone			
Cavity Fixings								
X						up to 50KG	up to 17KG	PLATTI TPP
X						up to 40KG	up to 16KG	TMX Hollow Wall Anchors
X						up to 25KG	up to 7.5KG	DUO MAX
X						up to 20KG	up to 6KG	MONO MAX
X						up to 20KG	up to 8KG	DRIVA TPD Plasterboard Anchor
X						up to 10KG	up to 15KG	TOG Spring Toggle
Masonry Fixings								
Suitable Structural Base Material						Max. Load Recommendation Shear* (Concrete C25)	Max. Load Recommendation Tension* (Concrete C25)	Your Fixing
Board materials	Solid concrete	Lightweight concrete	Solid Bricks	Hollow bricks/blocks	Stone			
	X		X	X	X	up to 780KG	up to 450KG	Sleeve Anchors
	X	X	X	X	X	up to 100KG	up to 80KG	GREPI TPH Super Plug
	X	O	X	O	X	up to 30KG	up to 20KG	THI Nail Plug
X	X	+	X	X	X	-	-	TMP Concrete Screw
General Fasteners								
Suitable Structural Base Material						Max. Load Recommendation Shear*	Max. Load Recommendation Tension*	Your Fixing
Board materials	Solid concrete	Lightweight concrete	Solid Bricks	Hollow bricks/blocks	Stone			
X	+	+	+	+	+	-	-	Clipsal Screws and Clips

X = recommended, O = possible but with reduced performance, + = requires additional accessories.

*Consult the technical catalogue for specific load ratings.

Fixing Guide



PLATTI TPP

Heaviest load rating for board materials, captive fixing.

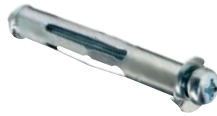

TMX Hollow Wall Anchors

Use tool for quick installation, captive fixing.



DUO MAX

Nylon wings push cavity insulation aside, captive fixing.



MONO MAX

Performs well in soft plasterboard, small drill hole, captive fixing.



DRIVA TPD
Plasterboard Anchor

No pre-drilling required.



TOG Spring Toggle

Heavy tension loads in board materials.



Sleeve Anchors

Heaviest load ratings.



GREPI TPH
Super Plug

Vibration resistance, ideal for hebel and light concrete.



THI Nail Plug

Quick installation.

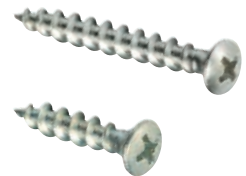

TMP Concrete Screw

For direct use in concrete (predrill holes, no plugs).



Clipsal Screws and Clips



Technical Information

Installation Material

Terminology

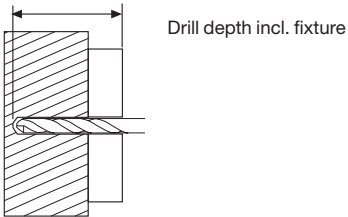
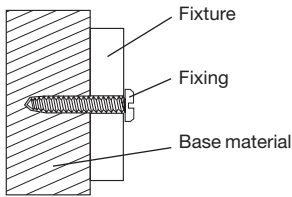

Types of load

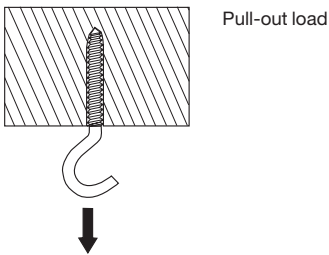

Pull-out load

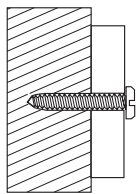

Shear load

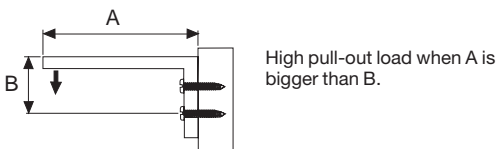

High pull-out load when A is bigger than B.

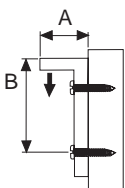

Low pull-out load when A is smaller than B.

Recommended load

Strictly speaking, the recommended loads for the fixings should be listed in newtons or kilo newtons (N or kN), as they are forces. But fixing calculations generally start from the weight of the fixture. For the sake of simplicity, we have chosen to give all loads in N or kN and suggest that the appropriate conversion of 1kN = approximately 100kg should be used.

Our tests are performed together with internationally recognised testing institutes.

The test results presented in this catalogue include a safety factor. This implies that all recommended loads stated by us can safely be used.

Step 1. Calculate the load

Often pull-out load appears together with shear load. Wall-mounted shelves are one example. The pull-out load increases with the distance from the wall. In most cases it is sufficient to add an extra margin, but be aware of the substantial pull-out load created in bracket fixings with high loads placed far out from the wall.

Step 2. Choose the fixing to suit the base material

Concrete

Recommendations in this document are based on C25 (strength of 25 N/mm²) concrete or better.

Solid bricks and blocks

Fixing in brick or block walls is one of the most frequent fixing situations.

Fixing of light fittings to a brick or block wall presents few problems. Try to avoid mortar joints.

As a general rule a larger quantity of smaller fixings is safer than some few larger fixings.

Fixing of heavy fixtures to a brick or block wall is not recommended unless the wall has been designed for that purpose.

Technical Information

Installation Material

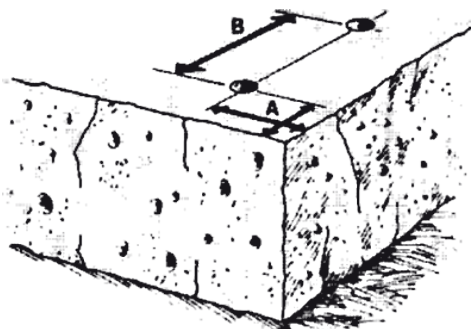

A = 5 to 10 times the hole diameter.
 (Example: Hole diameter = 10 mm. A = 50 to 100 mm)
 B = 10 to 20 times the hole diameter.

Board materials

All cavity fixings are tested in well-defined plasterboard (13 and 2x13mm) as being the most common board material.

We recommend only loads up to 80kg to be fixed directly in board materials. Heavier loads must be fixed in the structural elements.

Minimum edge distance and internal spacing

The distance between the fixing points and the nearest edge of the base material should exceed 5–10 times the hole diameter. The internal spacing between the fixing points should exceed 10–20 times the hole diameter.

These are general recommendations, the specific information is given in the technical data for the fixing.

Excessive heat

Fixings made of plastic material are not suitable in environments with temperatures above 60°C (140°F). For exact figures, see the technical data for each specific fixing element.

Fireproof fixings

Always consider the consequences of a fire. Do not use fixings made of plastic for fixtures in ceilings and on walls near emergency exits.

Atmospheric corrosivity categories and examples of typical environments

Corrosivity category	Examples of typical environments in a temperate climate (informative only)	
	Outdoors	Indoors
C1 very low	–	Heated buildings with clean atmospheres, e.g. offices, shops, schools, hotels.
C2 low	Atmospheres with low level of pollution. Mostly rural areas.	Unheated buildings where condensation may occur, e.g. depots, sports halls, multi-storey car parks.
C3 medium	Urban and industrial atmospheres, moderate sulphur dioxide pollution. Coastal areas with low salinity.	Production rooms with high humidity and some air pollution, e.g. food-processing plants, laundries, breweries, dairies.
C4 high	Industrial areas and coastal areas with moderate salinity.	Chemical plants, swimming-baths, coastal ship and boatyards, carwashes.
C5-I very high (industrial)	Industrial areas with high humidity and aggressive atmosphere.	Buildings in areas with almost permanent condensation and with high pollution.
C5-M very high (marine)	Coastal and offshore areas with high salinity.	Buildings in areas with almost permanent condensation and with high pollution.

Cavity Fixings

PLATTI TPP

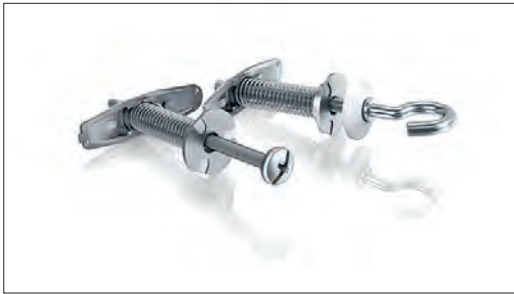

Description

PLATTI TPP is a zinc cavity fixing consisting of a toggle and a collar, united by a spring and a screw or hook.

Application

For installations in board materials ranging from a thickness of 10 to 35mm. Also suitable for ceiling installations.

Benefits

- Captive fixing – never lose toggle in wall cavity
- No special tool needed for the installation
- Large metal toggle – withstands humidity, heat and heavy loads
- Suitable for ceiling installations
- Highest load values for cavity fixings
- Fire-resistant
- Easy to remove – cut off the spring



Material Data

Material	Toggle, collar: zinc
	Screw, hook: electroplated steel
	Spring: steel

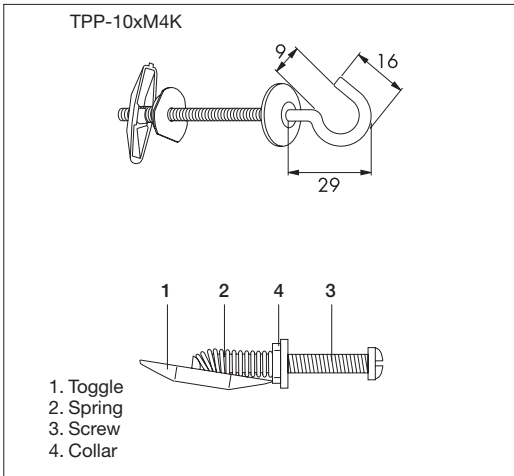

Installation

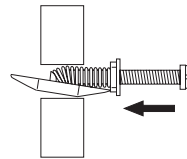

Drill a hole in accordance with the table below. Fix the toggle in the collar and push the cavity fixing in with the aid of the screw.

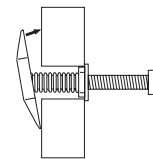

Push the screw until the spring-loaded bar flips over.

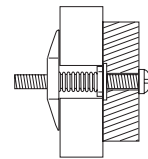

Remove the screw and mount the fixture.

Technical Data

Type	Screw size	Drill Ø mm	Board thickness (mm)	Max. fixture thickness for board thickness		Practical loading capacity, shear/pull-out load, N ¹⁾	
				13mm	2x13mm	13mm	2x13mm
TPP-10xM4S	M4x55	10	10-30	37mm	24mm	400/160	600/220
TPP-10xM4K	M4x50	10	10-26	-	-	-/160	-/220
TPP-13xM5S	M5x65	13	10-35	47mm	34mm	500/170	800/340

1) Safety factor 2.5 for shear and 3 for pull-out load.

Range

Type	Screw size	Qty per package	Part no.
Cavity fixing with screw			
Material: toggle and collar of zinc, screw and spring of steel.			
TPP-10xM4S	Screw M4 x 55	5 (hang sell)	IMT37498
TPP-13xM5S	Screw M5 x 60	5 (hang sell)	IMT37413
Cavity fixing with hook			
Material: toggle and collar of zinc, hook and spring of steel.			
TPP-10xM4K	Hook M4 x 50	2 (hang sell)	IMT37412

Cavity Fixings

DUO-MAX TSP



Description

DUO-MAX TSP is a nylon cavity fixing for high load values.

Application

For higher load installations in board materials, especially in applications with insulation.

Benefits

- Captive fixing – never lose toggle in wall cavity
- No special tool needed for the installation
- Pre-assembled screw
- Ready-to-mount – very fast installation
- High load values
- Easy to remove – cut off the spring
- Nylon wings push cavity insulation aside



Material and Operative Data

Material	Collar, spring, expanding part: polyamide (PA)
	Hook: electroplated steel
	Screw: electroplated steel
	Screw type M: nickel-plated brass
Temperature range	-40°C to 80°C

Installation

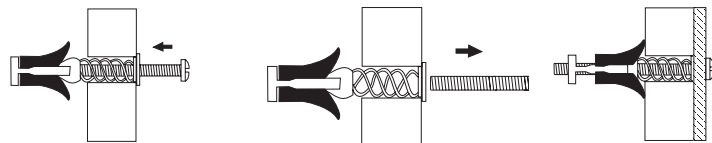

Drill a hole in accordance with the table below. Push in DUO-MAX with the aid of the screw.

Remove the screw.

Mount the fixture.

Technical Data

Type	Screw size	Drill Ø (mm)	Board thickness (mm)	Max. fixture thickness for board thickness		Practical loading capacity, N ¹⁾			
				13mm	2x13mm	13mm sheet		2x13mm sheet	
						Shear	Pull-out	Shear	Pull-out
TSP-6/50	M3x50	6	3-26	20mm	7mm	180	70	240	90
TSP-10/50	M5x50	10	3-20	12mm	—	250	75	—	—
TSP-10/75	M5x75	10	3-40	37mm	24mm	250	75	400	150

1) Safety factor 4.5 for shear and 6 for pull-out load.

Range



Type	Colour	Dimensions B/A/B (mm)		Qty per package	Part no.
Cavity fixing with screw					
Cavity fixing in two different sizes, with screw. Installed without special tools. To be used for installations in one or several layers of plasterboard and in other board materials. Material: polyamide (PA), electroplated steel screw.					
TSP-6/50	Red/white	52/11		25	1240 001
TSP-10/50	Blue/white	54/20		25	1244 003
TSP-10/75	Blue/white	77/20		25	1249 002
TSP-10/50	Blue/white	54/20		5 (hang sell)	IMT37415
TSP-10/75	Blue/white	77/20		5 (hang sell)	IMT37416

Cavity Fixings

MONO-MAX TMM



Description

MONO-MAX TMM is a nylon cavity fixing for lightweight installations in plasterboard. Supplied without screw.

Application

For installations in board materials ranging from 3 to 26mm thickness.

Benefits

- Captive without screw – never loose toggle in wall cavity
- No special tool needed for the installation
- Requires only 15mm of cavity space behind the board
- Small drill hole – 8mm
- Easy to remove – cut off the spring
- Provides strong hold in soft plasterboard

Material and Operative Data

Material	polyamide (PA)
Temperature range	-40°C to 80°C



Installation

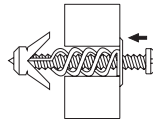

Drill a hole, Ø 8mm. Push the cavity fixing in with the aid of the screw.

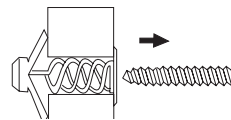

When the wings are gripping, remove the screw.

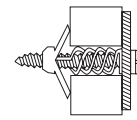

Mount the fixture.

Technical Data

Type	Rec. wood screw	Drill Ø (mm)	Board thickness (mm)	Max. fixture thickness	Practical loading capacity, N ¹⁾	
					Shear	Pull-out
TMM-8x26	No. 8	8	3-26	Determined by screw length	200	60

1) Safety factor 4.5 for shear and 6 for pull-out load.

Range



Type	Colour	Dim. (mm)	Qty per package	EAN code	Part no.
Cavity fixing without screw					
Cavity fixing without screw for lightweight installations in board materials. Material: polyamide (PA).					
TMM-8x26	White	26/13/16	100	7315881206025	1206 028

Cavity Fixings

Spring Toggle

TOG

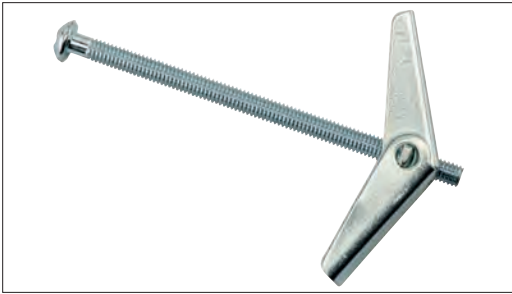

Description

Economical metal cavity fixing for high load value installations in plasterboard materials.

Benefits

- Ideal for overhead cavity fixing
- Spreads load over wide area
- Economical

Material and Operative Data

Material	Cavity fixing: yellow-chromated steel Screw: electroplated steel
Temperature range	-40°C to 80°C

Technical Data

Type	Drill (mm)	Screw size Ø x length (mm)	Max. fixture plus wall thickness (mm)	Practical loading capacity in 13mm board, N	
				Shear	Pull-out
1208 016	11	M3x50	40	100	100
1208 057	15	M5x50	35	100	150
1208 060	15	M5x80	65	100	150

Range



Dim. (mm)	Qty per package	Part No.
Cavity fixing		
Material: steel, yellow-chromated (THW), electroplated (screw).		
10 M3 x 50	50	1208 016
15 M5 x 50	50	1208 057
15L M5 x 80	50	1208 060

Cavity Fixings

Hollow Wall Anchor

TMX



Description

TMX steel cavity fixing is intended for heavy loads. It is expanded with the aid of a hollow wall anchor installation tool or simply by tightening the screw with a screwdriver.

Application

For installations in various types of board, like plaster, plywood and particle boards, but also for board materials like plastic, sheet metal and laminate.

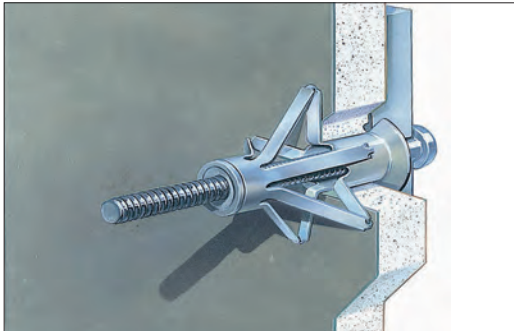

Benefits

- Captive fixing – stays fixed even when the screw is not tightened
- Anti-rotation design
- Pre-assembled screw
- High load values
- Fire-resistant
- Ideal for overhead cavity fixing

Material and Operative Data

Material cavity fixing	Expanding part: electroplated sheet metal Screw: electroplated steel
Material mounting tool	Steel and plastic
Temperature range	-40°C to 80°C

Installation

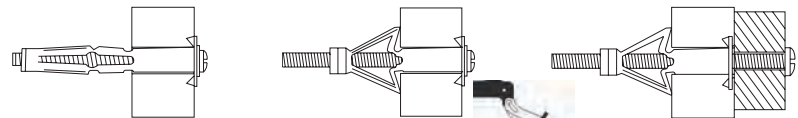

Drill a hole in accordance with the table below. Install the cavity fixing.

Expand the cavity fixing by using a screwdriver or the Hollow Wall Anchor tool.

Remove the screw and mount the fixture.

Technical Data

Type	Screw size	Screw length (mm)	Drill Ø (mm)	Board thickness Min.-Max. (mm)	Max. fixture thickness	Practical loading capacity, N	
						Shear	Pull-out
TMX-4E	M4	40	8	5-15	18	200	140
TMX-4D	M4	50	8	16-26	18	400	160

Range



Type	Screw	Dimensions Ø/L (mm)	Qty per package	Part no.
Cavity fixing with screw				
Cavity fixing including fully threaded screw with combi-head and Phillips cross-slot. Material: electroplated steel.				
TMX-4E	M4	14/47	100	1260 025
TMX-4E	M4	14/47	10 (hang sell)	IMT37418
TMX-4D	M4	14/62	50	1260 066
TMX-4D	M4	14/62	5 (hang sell)	IMT37419
TMX-5E	M5	16/62	50	1260 108
TMX-5E	M5	16/62	5 (hang sell)	IMT37420
TMX-6E	M6	18/62	50	1260 140

Cavity Fixings

Wallboard Anchor

DRIVA TPD

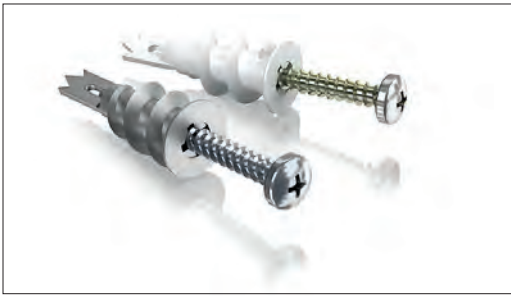

Description

TPD self-drilling cavity fixing is intended for lightweight installations in plasterboard.

Application

For installations in plasterboard from a thickness of 9mm, independent of the insulation behind. Not suitable for ceiling installations.

Benefits

- Self-drilling
- Fire resistant (TPD metal)
- Supplied complete with screws



Material and Operative Data

Material	TPD-Metal: zinc
	TPD-Nylon: polyamide (PA), glass fibre reinforced
	Screw: electroplated steel (TPD metal)
Temperature range	-40°C to 80°C

Installation

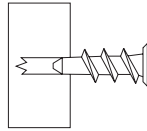

Screw the TPD into the plasterboard.

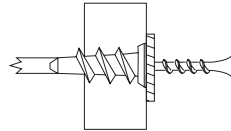

Mount the fixture by screwing the screw into the TPD.

Technical Data

Type	Screw size (mm)	Board thickness (mm)	Max. fixture thickness	Practical loading capacity in 13mm board, N ¹⁾	
				Shear	Pull-out
TPD metal	4.5x35	min. 9	26	200	80
TPD nylon	4.5x35	min. 9	12	190	50

1) Safety factor 2.5 for shear and 3 for pull-out load (TPD metal).
Safety factor 4.5 for shear and 6 for pull-out load (TPD nylon).

Range



Type	Screw size	Colour	Dim. Ø/L (mm)	Qty per package	Part no.
Cavity fixing, zinc					
Cavity fixing for lightweight installations in plasterboard, including wood screw with cross-slot Pozidriv 2. Material: zinc, electroplated steel screw.					
TPD metal	4.5x35	—	13/37	100 5 (hang sell)	1220 104 IMT37414



Cavity fixing, PA					
Cavity fixing for lightweight installations in plasterboard, including screw with cross-slot. Material: polyamide (PA), glass fibre reinforced, electroplated steel screw.					
TPD nylon	—	White	13/37	100	1220 010

Masonry Fixings

High Performance Plugs

GREPI TPH



Description

The TPH GrepI plug range includes high-performance wall plugs for demanding installations.

The nylon plug has a soft outer skin made of thermoplastic rubber. This outer skin acts as a shock absorber and also greatly improves the performance of the plugs in low-density concrete and softer brick materials.

The range consists of two different plug lengths, both with a diameter of Ø10mm. The long plug, with a length of 110mm, is suitable for through installation, whereas the short plug with a length of 67mm is suitable for regular plug installation.



Both plugs are provided with a specially designed acid-proof C5M screw, 72 or 115mm long. Screws have a Torx T30 recess.

The plugs are suitable for concrete, stone, and solid bricks, as well as low-density concrete and hollow blocks, such as Hebel.

Benefits

- High load values
- Easy to install
- Self-centering design of the screw
- Shock absorbing design provides vibration resistance
- Soft outer thermoplastic skin prevents rotation
- Acid proof C5M stainless steel screw with Torx T30 recess
- Ideal for hebel and other light concrete

Material and Operative Data

Material	Polyamide 6 (PA6) with Thermoplastic rubber (TPR) outer skin
Screw material	Case-hardened carbon steel with Zn/Ni Profin C4 (C4-Class)
Temperature range	From -20 to 60°C

Installation

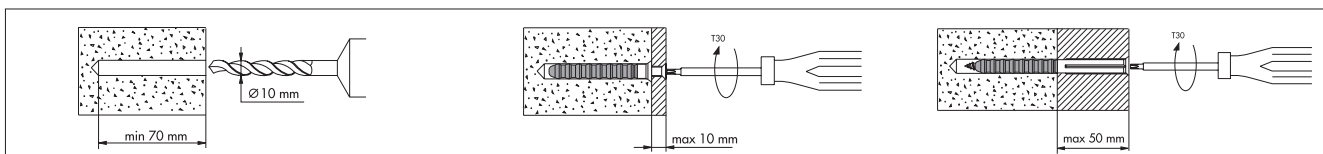

Technical Data

Type plug Ø x plug length (mm)	Drill Ø (mm)	Min. drill depth (mm)	Max. thickness of fixture (mm)	Recommended Load ¹⁾			
				kN		Low-density ²⁾ concrete (500 grade) and expanded clay kN	
				Pull-out	Shear	Pull-out	Shear
TPH-10x67WS	10	70	10	0.8	1.0	0.6	0.7
TPH-10x110WS	10	70	50	0.8	0.3	0.6	0.3

1) Safety factor for pull-out load 3 and shear load 2.5.

2) Low-density concrete might also be called lightweight or aerated concrete.

Range



Type	Screw length (mm)	Colour	Dimensions Ø/length (mm)	Qty per package	Part no.
Plug with screw					
TPH-10x67WS	72	Green/black	Ø10/67	20	IMT39082
High-performance plug with specially designed acid-proof C5M screw. Suitable for through-installations. Material: PA/TPR.					
TPH-10x110WS	115	Green/black	Ø10/110	20	IMT39086

Masonry Fixings

Nail Plugs

THI



Description

Nail plugs with countersunk collar for all types of through installation.

Applications

All types of through installation, such as electrical trunking, switches, battens and cable clamps.

Suitable for concrete, stone and solid, perforated and hollow bricks.

Benefits

- Removable hammer-in fixing
- Fast installation
- Long expansion zone for optimum stability
- Through fixing

Material and Operative Data

Plug	Polyamide (PA)
Screw nail	Steel, electroplated
Temperature range	From -40° to 80°C



Installation

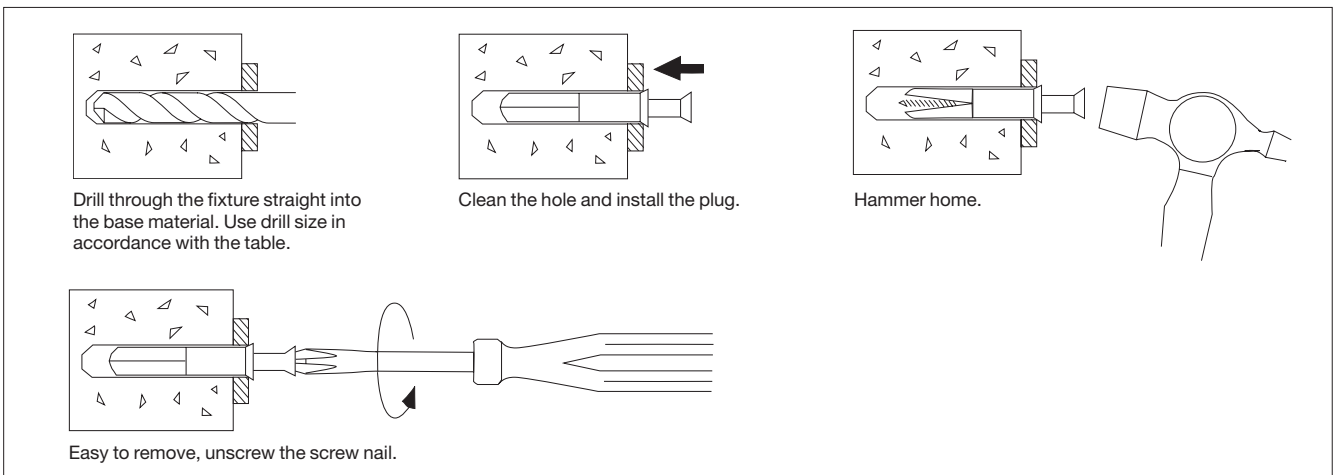

Technical Data (1kN approx. 100kg)

Type drill Ø x plug length mm/max. fixture thickness	Plug Ø (mm)	Min. drill depth (mm)	Max. thickness of fixture (mm)	Recommended load shear/pull-out ¹⁾		
				Concrete C25 kN	Solid brick kN	Sandstone kN
5x30/5	Clear	Ø5/30	100	0.25	0.25	0.15/0.05
5x50/25	Clear	Ø5/50	100	0.25/0.1	0.25/0.1	0.15/0.05
6x35/5	Clear	Ø6/35	100	0.3/0.2	0.3/0.2	0.2/0.07
6x50/20	Clear	Ø6/50	100	0.3/0.2	0.3/0.2	0.2/0.07
6x70/40	Clear	Ø6/75	100	0.3/0.2	0.3/0.2	0.2/0.07

1) Safety factor 4.5 for shear and 6 for pull-out load.

Range



Type	Colour	Dimensions Ø/length (mm)	Qty per package	Part no.
Material: Polyamide (PA).				
5x30/5	Clear	Ø5/30	100	1131 110
5x50/25	Clear	Ø5/50	100	1131 115
6x35/5	Clear	Ø6/35	100	1131 130
6x50/20	Clear	Ø6/50	100	1131 135
6x70/40	Clear	Ø6/75	100	1131 145

Masonry Fixings

Installation Screws

TMP-C3



Description

Installation screw with raised countersunk head and Phillips PH2 recess. Corrosivity category C3.

Applications

Suitable for direct use in plasterboard and for 4mm drilled holes in concrete and bricks.

Benefits

- Documented quality
- Type-approved
- Corrosion classified in category C3
- Raised countersunk head
- Fully threaded – works well in thin materials

Material and Operative Data

Material	Hardened, electroplated steel
Standards and regulations	Corrosivity category C3 in accordance with SS-EN ISO 12944-2

Range



Type	Dimension Ø x length (mm)	Qty per package	EAN code	Internal ID no.	Part no.
Installation screw TMP-C3					
Material: hardened, electroplated steel.					
TMP-C3-5,0x45	5.0x45	100	7315883764035	20051500	3764 030

Masonry Fixings

Sleeve Anchors



Description

The Schneider Electric Sleeve Anchor is a heavy duty, torque controlled, expansion anchor for installations in concrete, bricks and natural rock materials.

Benefits

- Installs directly in concrete, bricks and natural rock material
- High-quality anchor
- Quick and easy through-fixing installation

Material and Operative Data

Material steel bolt	Steel
Surface treatments	Electroplated zinc, C2

Installation

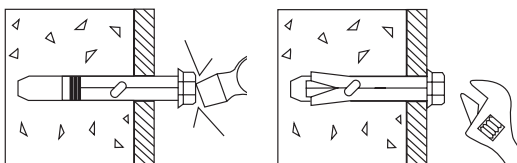

1. Insert the anchor through the fixture and drive home with a hammer until the washer contacts the fixture.

2. Tighten the nut to expand the sleeve and secure the fixture firmly.

Technical Data

Part no.	Fastener material up to (mm)	Hole diameter (mm)	Min. hole depth (mm)	Thread size (mm)	Max. Rec. Load shear/pull-out in 30N/mm ² Concrete kN	Tightening torque Nm
1501 500	5	8	35	M6	3.0/2.0	9
1501 506	30	8	35	M6	3.0/2.0	9
1501 510	50	8	35	M6	3.0/2.0	9
1501 520	10	10	40	M8	3.5/2.7	20
1501 526	37	10	40	M8	3.5/2.7	20
1501 530	57	10	40	M8	3.5/2.7	20
1501 540	10	12	50	M10	5.5/4.0	39
1501 546	25	12	50	M10	5.5/4.0	39
1501 550	49	12	50	M10	5.5/4.0	39
1501 556	79	12	50	M10	5.5/4.0	39
1501 560	10	16	55	M12	7.8/4.5	65
1501 566	56	16	55	M12	7.8/4.5	65

Range

Dimensions Ø x length (mm)	Qty per package	Part no.
Corrosivity class C2		
Material: steel, electroplated zinc.		
8x40	100	1501 500
8x65	100	1501 506
10x50	100	1501 520
10x80	50	1501 526
10x97	50	1501 530
12x60	50	1501 540
12x75	50	1501 546
12x99	30	1501 550
12x129	30	1501 556
16x65	20	1501 560
16x111	20	1501 566
Hook Bolt M8*	25	1511 234
Eye Bolt M8*	25	1511 227
Shield Anchor M8x55mm	100	1511 203

*M8 Hook and Eye Bolts may require 1511203 shield anchors for masonry applications. Shield anchors are sold separately.

Cable Management

Cable Wings

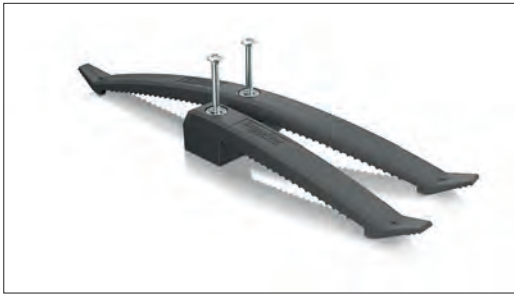

Description

The Cable Wing fixing clip can be used both for indoor and outdoor applications.

The Cable Wing is available both as a single clip for cable installation on one side only and as a double clip for cable/conduit installation on both sides.

Made of polyamide with high UV-resistance and durability.

Benefits

- Fast installation with a hammer when using the nail plug
- Nail plug installation means that the Cable Wing can be adjusted or even removed and re-used
- High UV-resistance
- Halogen-free
- Can withstand high impact together with extremes of heat and cold
- Flexible wings so that cables can be easily added or removed

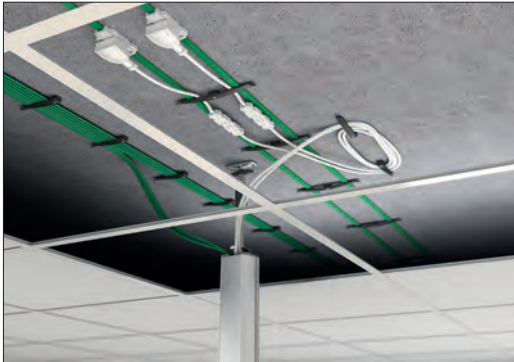

Material and Operative Data

Material	Cable wing, nail plug: polyamide (PA) Screw nail: steel with electroplated zinc surface treatment
Cable capacity	Maximum diameter 12mm Maximum capacity 6 cables per side
Colour	Dark grey
Temperature range	From -20°C to 60°C
Recommended load	30 N

Range

Type	Colour	Dimensions A/B/C (mm)	Qty per package	Part no.
Cable wing, double				
Material: PA.				
With nail-plug	Dark grey	23/20/230	25	IMT39080
Without nail-plug	Dark grey	23/20/230	2 (hang sell)	IMT37489
Cable wing, single				
Material: PA.				
With nail-plug	Dark grey	20/20/130	25	IMT39078
Without nail-plug	Dark grey	20/20/130	2 (hang sell)	IMT37488

General Fasteners

Screws





Screws Range

	Reference	Description	Pack type	Quantity	
	357TB	357TB Tackle Box with 357 Screw Tackle	Box	-	
	248/20	Screw ST 3/16BSWX20mm CH HD	Hang sell	100	
	248/25	Screw ST 3/16BSWX25mm CH HD	Hang sell	100	
	357/20	Screw Self Drill 7X20mm Bugle HD	Hang sell	100	
	357/25	Screw Self Drill 7X25mm Bugle HD	Hang sell	100	
	357/30	Screw Self Drill 7X30mm Bugle HD	Hang sell	100	
	357/35	Screw Self Drill 7X35mm Bugle HD	Hang sell	100	
	357/40	Screw Self Drill 7X40mm Bugle HD	Hang sell	100	
	357/45	Screw Self Drill 7X45mm Bugle HD	Hang sell	100	
	357/50	Screw Self Drill 8X50mm Bugle HD	Hang sell	100	
	357/63	Screw Self Drill 8X63mm Bugle HD	Hang sell	100	
	357/75	Screw Self Drill 8X75mm Bugle HD	Hang sell	100	
	357P20	Screw Self Drill 6GX20 Pan HD	Hang sell	100	
	357P30	Screw Self Drill 6GX30 Pan HD	Hang sell	100	
	357P40	Screw Self Drill 6GX40 Pan HD	Hang sell	100	
	357P50	Screw Self Drill 6GX50 Pan HD	Hang sell	100	
	357PH12	Screw 7GGEX12 Pan HD	Hang sell	100	
	357PH20	Screw 7GGEX20mm Pan HD	Hang sell	100	
	357PH25	Screw 7GGEX25mm Pan HD	Hang sell	100	
	357PH30	Screw 7GGEX30mm Pan HD	Hang sell	100	
	357PH40	Screw 7GGEX40mm Pan HD	Hang sell	100	
	357PH45	Screw 7GGEX45mm Pan HD	Hang sell	100	
	357PH50	Screw 7GGEX50mm Pan HD	Hang sell	100	
	357WF22	Screw Self Drill 10GX22 Wafer HD	Hang sell	100	
	357WF30	Screw Self Drill 10GX30 Wafer HD	Hang sell	100	
	357WF40	Screw Self Drill 10GX40 Wafer HD	Hang sell	100	
	357WH12	Screw Self Drill 8GX12 Washer HD	Hang sell	100	
	357WH25	Screw Self Drill 8GX25 Washer HD	Hang sell	100	
	357WHP32	Screw Self Drill 8GX32 Washer HD	Hang sell	100	
	357/20J	Screw 500 Bugle Jar 7X20mm	Jar	500	
	357/25J	Screw 400 Bugle Jar 7X25mm	Jar	400	
	357/30J	Screw 325 Bugle Jar 7X30mm	Jar	325	
	357/35J	Screw 250 Bugle Jar 7X35mm	Jar	250	
	357/40J	Screw 175 Bugle Jar 7X40mm	Jar	175	
	357/45J	Screw 175 Bugle Jar 7X45mm	Jar	175	
	357/50J	Screw 125 Bugle Jar 8X50mm	Jar	125	
	357/63J	Screw 100 Bugle Jar 8X63mm	Jar	100	
	357/75J	Screw 80 Bugle Jar 8X75mm	Jar	80	
	357P20J	Screw 500 Pan HD Jar 6X20mm	Jar	500	
	357P30J	Screw 325 Pan HD Jar 6X30mm	Jar	325	
	357P40J	Screw 250 Pan HD Jar 6X40mm	Jar	250	
	357P50J	Screw 175 Pan HD Jar 6X50mm	Jar	175	
	357PH12J	Screw 500 Pan HD Jar 7X12mm	Jar	500	
	357PH20J	Screw 500 Pan HD Jar 7X20mm	Jar	500	
	357PH25J	Screw 400 Pan HD Jar 7X25mm	Jar	400	
	357PH30J	Screw 325 Pan HD Jar 7X30mm	Jar	325	
	357PH40J	Screw 200 Pan HD Jar 7X40mm	Jar	200	
	357PH50J	Screw 150 Pan HD Jar 7X50mm	Jar	150	
	357WF22J	Screw 90 Wafer Jar 10X22mm	Jar	90	
	357WF30J	Screw 70 Wafer Jar 10X30mm	Jar	70	
	357WF40J	Screw 50 Wafer Jar 10X40mm	Jar	50	
	357WH12J	Screw 400 Washer HD Jar 8X12mm	Jar	400	
	357WH25J	Screw 250 Washer HD Jar 8X25mm	Jar	250	
	357WHP32J	Screw 140 Washer HD Jar 8X32mm	Jar	140	
	357/20B	Screw Self Drill 7GX20mm Bugle HD	Bucket	1000	
	357/25B	Screw Self Drill 7GX25mm Bugle HD	Bucket	1000	
	357/30B	Screw Self Drill 7GX30mm Bugle HD	Bucket	1000	
					

General Fasteners

Screws

Screws Range

	Reference	Description	Pack type	Quantity	
357/45B 	357/40B	Screw Self Drill 7GX40mm Bugle HD	Bucket	500	
	357/45B	Screw Self Drill 7GX45mm Bugle HD	Bucket	500	
	357/50B	Screw Self Drill 8GX50mm Bugle HD	Bucket	500	
	357/63B	Screw Self Drill 8GX63mm Bugle HD	Bucket	250	
	357/75B	Screw Self Drill 8GX75mm Bugle HD	Bucket	250	
	357P20B	Screw Self Drill 6GX20 Pan HD	Bucket	1000	
	357P30B	Screw Self Drill 6GX30 Pan HD	Bucket	1000	
	357P40B	Screw Self Drill 6GX40 Pan HD	Bucket	500	
	357P50B	Screw Self Drill 6GX50 Pan HD	Bucket	500	
	357PH12B	Screw Self Drill 7GX12 Pan HD	Bucket	1000	
353 	357PH20B	Screw Self Drill 7GX20 Pan HD	Bucket	1000	
	357PH25B	Screw Self Drill 7GX25 Pan HD	Bucket	1000	
	357PH30B	Screw Self Drill 7GX30 Pan HD	Bucket	1000	
	357PH40B	Screw Self Drill 7GX40 Pan HD	Bucket	500	
	357PH45B	Screw Self Drill 7GX45 Pan HD	Bucket	500	
	357PH50B	Screw Self Drill 7GX50 Pan HD	Bucket	500	
	357WF22B	Screw Self Drill 10GX22 Wafer HD	Bucket	500	
	357WF30B	Screw Self Drill 10GX30 Wafer HD	Bucket	500	
	357WF40B	Screw Self Drill 10GX40 Wafer HD	Bucket	500	
	355 	357WH12B	Screw Self Drill 8GX12mm Washer HD	Bucket	1000
357WH25B		Screw Self Drill 8GX25mm Washer HD	Bucket	500	
357WHP32B		Screw Self Drill 8GX32mm Washer HD	Bucket	500	
31JScrew		Screw J switch mech fixing	Box	100	
353		Screw 1/2X6 NC RSD CSK HD	Box	100	
355		Screw 32mmX6 NC SLOT PH HD	Box	100	
355A		Screw RSD PH HD COM SL ZP	Box	100	
359 		359	Nut 6NC 32TPI Square	Box	100
		B25-FS	50mm Facia Screw for B25A	Box	10
		BSL25-FS	Screw Facia for B & BSL 75mm	Box	10
	353B	Screw 5/8X6 NC RSD CSK HD	Box	100	
	355B	Screw 3X6 NC RSD CSK HD	Box	100	

General Fasteners

Cable Clips, Pin Clips and Hand Tools

Cable Clips Range

	Reference	Description	Pack type	Quantity
564/I	564/0	Clip Cable 1.5mm ² 3 Core	Box	100
	564/1	Clip Cable 2.5mm ² 3 Core	Box	100
	564/2	Clip Cable 4mm ² 3 Core	Box	100
	564/3	Clip Cable 6mm ² 3 Core	Box	100
	564/4	Clip Cable 16mm Flat CBL	Box	100
	564M10	Clip Cable 10mm DIAM	Box	100
	564M12	Clip Cable 12mm DIAM	Box	100
	564M4	Clip Cable 4mm DIA & 1mm SDI	Box	200
	564M5	Clip Cable 5mm DIA & 2.5mm SDI	Box	100
	564M6	Clip Cable 6mm DIAM	Box	100
564/OJ	564M8	Clip Cable 8mm DIAM	Box	100
	2126019	Clip Cable 2.5mm ² 2 Core and 1.5mm ² 3 Core	Box	100
	2131019	Clip Cable 4-6mm ² 2 Core and 2.5mm ² 3 Core	Box	100
	2136018	Clip Cable 10-16mm ² 2 Core	Box	100
	564/00J	Clip Cable 2 Core FIG8 0.75mm ²	Jar	300
	564/0J	Clip Cable 3 Core Flat 1mm ²	Jar	150
	564/1J	Clip Cable 3 Core Flat 2.5mm ²	Jar	100
	564/2J	Clip Cable 3 Core Flat 4mm ²	Jar	70
	564/3J	Clip Cable 3 Core Flat 6mm ²	Jar	70
	564M10J	Clip Cable 10mm DIA Circular	Jar	100
564/1BKT	564M12J	Clip Cable 12mm DIA Circular	Jar	70
	564M4J	Clip Cable 4mm DIA & 1mm ² SDI	Jar	300
	564M5J	Clip Cable 5mm DIA & 2.5mm ² SDI	Jar	200
	564M6J	Clip Cable 6mm DIA & 1mm ² 2 Core	Jar	100
	564M8J	Clip Cable 8mm DIA Circular	Jar	150
	564/0BKT	Clip Cable 1.5mm ² 3 Core	Bucket	700
	564/1BKT	Clip Cable 2.5mm ² 3 Core	Bucket	500
	564/3BKT	Clip Cable 6mm ² 3 Core	Bucket	500
	564/0BB	Clip Cable 1.5mm ² 3 Core	Bulk Bin	6000
	564/1BB	Clip Cable 2.5mm ² 3 Core	Bulk Bin	5000
2126711	Clip Cable 2.5mm ² 2 Core and 1.5mm ² 3 Core	Bulk Bag	2000	

Pin Clips Range

	Reference	Description	Pack type	Quantity
564PC2	564PC1	Pin Clip BR Size 1-38mm	Box	200
	564PC2	Pin Clip BR Size 2-44mm	Box	200
	564PC3	Pin Clip BR Size 3-51mm	Box	200
	564PC4	Pin Clip BR Size 4-57mm	Box	200
	564PC5	Pin Clip BR Size 5-67mm	Box	200

Hand Tools Range

	Reference	Description	Pack type
852QCP	357NS	Bit Power 5/16 Nutsetter	Hang sell
	357PB	Bit Screw Power Drive	Hang sell
	357PB150	Power Drive Bit 150mm Long Phillips N2	Hang sell
	357PB2	Bit Screw Power Double End	Hang sell
	357PBU	Bit Screw Power #2 Phil HD 6mm	Hang sell
853SK	852QCP	Tool Pliers Stripper QC Range	Hang sell
	852QCPH	Tool Pliers Stripper QC 1000V	Hang sell
	853SK	Kit Screwdriver Set	Hang sell
	900TC	Tool Cutter Mini Trunking	Hang sell
	900TCA	Tool Cutter Trunking Anvil	Hang sell



To find out more visit clipsal.com/fixings

Schneider Electric (Australia) Pty Ltd

33-37 Port Wakefield Road
Gepps Cross, SA 5094

PO Box 132
Enfield Plaza, SA 5085

Tel: 1300 369 233
Email: plugin@clipsal.com.au

Access this document directly:
clipsal.com/brochures

78 Waterloo Road
Macquarie Park, NSW 2113

Locked Bag 2211
North Ryde, NSW 2113

Tel: 1300 369 233
Fax: 1300 369 288
Email: customercare.au@schneider-electric.com

www.schneider-electric.com.au

Schneider Electric (Australia) Pty Ltd reserves the right to change specifications, modify designs and discontinue items without incurring obligation and whilst every effort is made to ensure that descriptions, specifications and other information in this catalogue are correct, no warranty is given in respect thereof and the company shall not be liable for any error therein.

Trademarks are owned by Schneider Electric Industries SAS or its affiliated companies.

This document has been printed using FSC Mix Certified paper. ISO 14001 environmental management system in use at mill.