

Clipsal Datacomms

PRODUCT SELECTION GUIDE

EDITION 13

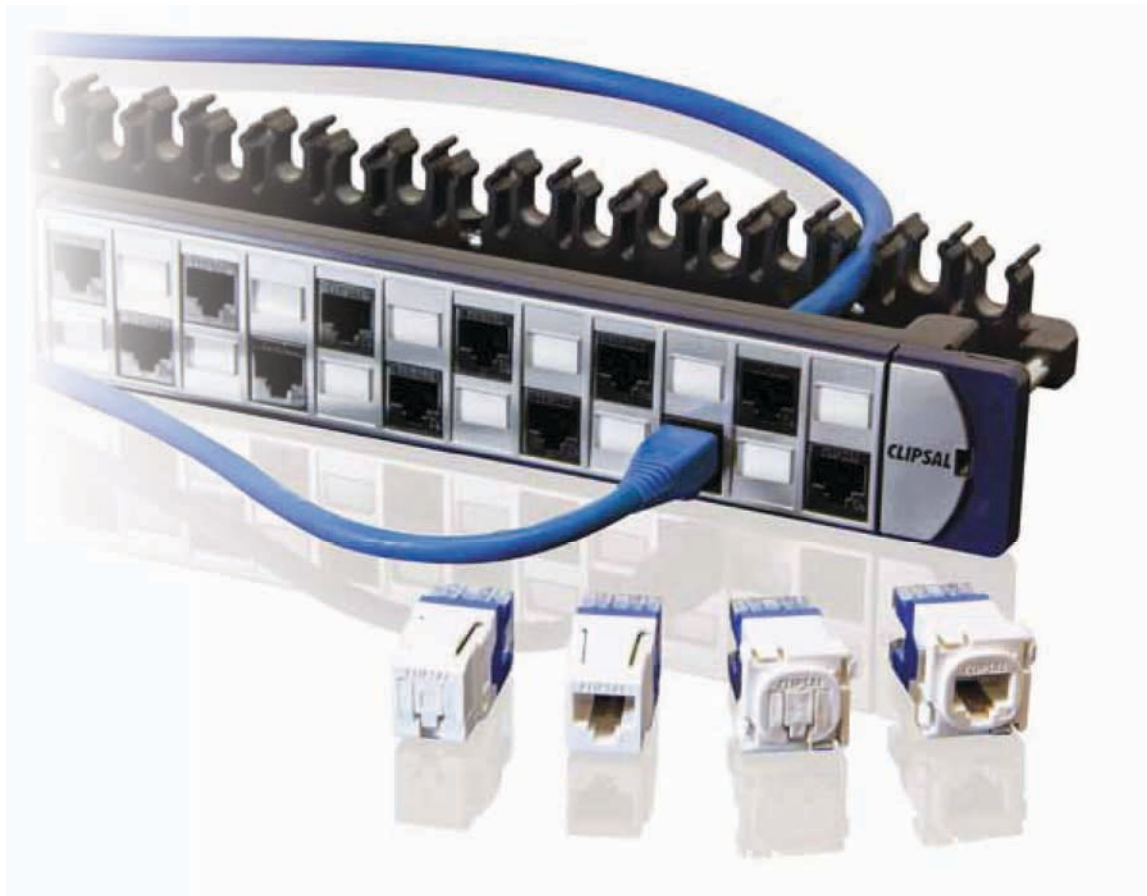

Established in 1997, Clipsal Datacomms has surpassed all expectations to become a market leader in Australia's thriving data and communications industry.

The diversity and depth of the Clipsal Datacomms range establishes us in a unique position to offer a comprehensive 'end-to-end' solution. The Datacomms pursuit of solution excellence does not end with innovative products and leading edge solutions, but is demonstrated through our commitment to working closely with consultants, installers and customers to ensure a successful end result.

The Clipsal Datacomms products include a comprehensive range of Category 3, 5e, 6, 6A and fibre optics structured cabling products. These products are supported by a range of cabinets and accessories to complete your end-to-end solution.

C L I P S A L L A B S

At Clipsal Datacomms we have a strong commitment to research and development, whether it be in our own laboratories in Australia, or in our parent company (Schneider Electric) laboratories around the globe. Product design is shared between Australia, France, Denmark and Hong Kong, which allows around the clock, 24 hour product design, and gives a team of experienced engineers both a local and global perspective. Schneider Electric is committed to Research and Development by investing 5% of revenue into solution development.

A G R E E N E R F U T U R E











We have embarked on a PVC-minimization program across the whole Clipsal organization. The release of our low smoke, zero halogen range of cables is evidence of our commitment to this program. We have also reduced conventional PVC usage across the whole Clipsal range to the point where 94% of Clipsal products are now PVC free. Clipsal products are also manufactured in accordance with the ROHS directive 2002/95/EC (restricting the use of certain hazardous substances in electrical and electronic equipment). At Clipsal, 85% of products are packed and distributed in packaging that is made from 85% recyclable materials.

S T A N D A R D S

At Clipsal Datacomms we have representation on many Australian Standards Committees, ensuring that all products are standards compliant, and giving a voice to our customers. We also provide valuable input to the International Standards that affect our capabilities in delivering the right product for the future, our knowledge of global trends.

T R A I N I N G

We at Clipsal Datacomms continue to train our valued customer base, and were the first to gain BICSI endorsement for our UTP and fibre testing courses, and remain committed to delivering these courses in the future. We have trained many thousands of industry players over the years from our distribution channels, to contractors, engineers and end users.

CATEGORY 3 VOICE AND TELEPHONE EQUIPMENT	5	
CATEGORY 5e UTP RJ45 SOLUTION	27	
CATEGORY 6 UTP RJ45 SOLUTION	43	
CATEGORY 6 PATCH BY EXCEPTION (PBE) SOLUTION	59	
CATEGORY 6A UTP RJ45 SOLUTION	67	
WALL PLATES AND LABELLING	79	
OPTICAL FIBRE SOLUTION	89	
ACTIVE EQUIPMENT	109	
19" SYSTEM ENCLOSURES AND ACCESSORIES	113	
DUCTING AND FITTINGS	193	
MISCELLANEOUS SECTION	213	
CLIPSAL DATACOMMS LIFETIME WARRANTY	217	
TECHNICAL INFORMATION, GLOSSARY AND INDEX	221	

CATEGORY 3 VOICE AND TELEPHONE EQUIPMENT

Connection Accessories

Modules

Backmount Frames

Clip-on Frames

Cable Management

Frame Covers

Enclosures

Accessories

Jumper Wire

Telephone Cable Colour Codes

Telephone Cables

Category 3 Connection Accessories

Clipsal Category 3 connection accessories offer outstanding reliability for your Category 3 voice and telephone needs. The product range can be used anywhere beyond first point and are ideal for any voice and telephone applications, while conveniently fitting into all Clipsal 30 Series wall plates.

Clipsal Category 3 connection accessories will accommodate cable gauge sizes between 22–26 AWG and are ACMA approved. All Clipsal Category 3 connection accessories are designed in Australia and have been a part of Australian households for over 25 years, so you can rely on Clipsal when it comes to quality and reliability.



30RJ66SM,WE



30RJ64SMT,WE

IDENTIFICATION TABLE

	RJ11 Series		RJ12 Series	
Catalogue Number	30RJ64SM	30RJ64SMT	30RJ66SM	30RJ66SMT
Front View (Contact)				
Rear View (Terminal)				
Circuit/Contacts	6 Way/4 Contacts (Equivalent to RJ11)		6 Way/6 Contacts (Equivalent to RJ12)	
Schematic Wiring Diagram				
Marking	None	'TELEPHONE' 	None	'TELEPHONE'
Austel Permit	A91/831/0092			
Termination Tool	TRJ45PDT or 110 Tool			

CATALOGUE NUMBER	DESCRIPTION
30RJ64SM	Modular 6 Way, 4 Contact Socket/Mechanism (RJ11) (Colour Availability: WE, BK, CM, SG, BR, DS)
30RJ64SMT	Modular 6 Way, 4 Contact Socket/Mechanism "Telephone" (RJ11) (Colour Availability: WE, BK, CM, DS, SG)
30RJ66SM	Modular 6 Way, 6 Contact Socket/Mechanism (RJ12) (Colour Availability: WE, BK, CM, SG)
30RJ66SMT	Modular 6 Way, 6 Contact Socket/Mechanism "Telephone" (RJ12) (Colour Availability: WE, BK, CM, SG)

Category 3 Modules

Clipsal Datacomms offers a choice of disconnect, connection and earth modules, all compatible with backmount and clip-on style mounting frames.

The clip-on frames feature cylindrical mounts, allowing simple attachment and access to the rear of the modules. Single position label holders feature clip-on mounting to the frames, and hinged label holders can be connected to the front of the modules.

CONNECTION MODULE

The connection module terminates 10 incoming and 10 outgoing pairs. Mounting can be either clip-on or backmount.

DISCONNECT MODULE

The disconnect module can be wired for 10 incoming and 10 outgoing pairs. Mounting can be either clip-on or backmount.

EARTH MODULE RED

The earth module is used for connecting from a technical reference conductor (TRC) link bar of any distributor to the TRC of any distributor. It can also connect the TRC link to a separate telecommunications functional earth electrode 38 wire connection with backmount mounting.

ELECTRICAL SPECIFICATIONS

10 Pair Connection Module	
Housing/Base	PBT/PBT UL94V-0
Contacts	Phosphor bronze (0.5mm)
Plating	Silver (20µ) over nickel
Wire Size	0.4 ~ 0.8mm
Housing Colour	Grey
10 Pair Disconnection Module	
Housing/Base	PBT/PBT UL94V-0
Contacts	Phosphor bronze (0.5mm)
Plating	Silver (20µ) over nickel
Wire Size	0.4 ~ 0.8mm
Housing Colour	White
10 Pair TRC Earth Module	
Housing/Base	PBT/PBT UL94V-0
Contacts	Phosphor bronze (0.5mm)
Plating	Silver (100µ) over nickel
Wire Size	0.4 ~ 0.8mm
Housing Colour	Red



3100VDM10C



3100VCM10C

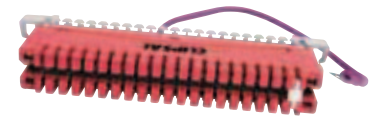

3100VEM10



3100LABHLDRH



3100LAB1HLDR



3100LHLDRC

PRODUCT FEATURES

- Backmount and clip-on compatible.
- 5 micron silver plating on contacts.
- Compatible with leading manufacturer frames.
- Pairs numbered 1-10.
- Includes plug numbers 0-10.
- A-Tick approved, N700.

CUSTOMER BENEFITS

- Ease of installation and maintenance.
- Simplicity of pair identification.

CATALOGUE NUMBER	DESCRIPTION
3100VDM10C	Disconnection Module – 10 Pair Clip-on/Backmount
3100VDM10C2	Disconnection Module – 10 Pair Clip-on/Backmount(2 pack)
3100VCM10C	Connection Module – 10 Pair Clip-on/Backmount
3100VEM10	Earth Module, Red, 38 Wire, Backmount
3100LABHLDRH	Label Holder, One Position, Hinged
3100LAB1HLDR	Label Holder, One Position, Backmount
3100LHLDRC	Label Holder, One Position, Clip-on

Category 3 Backmount Frames

Clipsal's range of backmount frames provides a simple solution for mounting modules for internal voice solutions. Fully compatible with leading voice manufacturer products, Clipsal backmount frames can be interlocked with existing telecommunications infrastructure.

Backmount frames are available for use as a main distribution frame (MDF), intermediate distribution frame (IDF) or floor distribution point (FDP).

DIMENSIONS

Product	A (width)	B (height)	C (depth)
3100F100MDF	195mm	360mm	75mm
3100F250MDF	195mm	710mm	75mm
3100F540MDF	195mm	1319mm	75mm

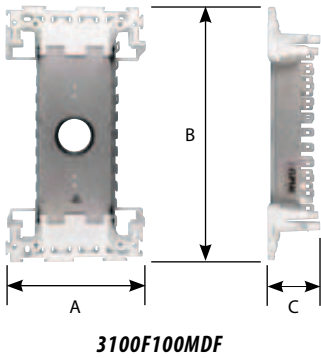

3100F100MDF

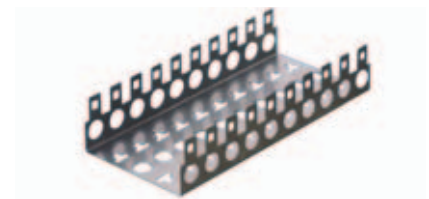

3100F100F

PRODUCT FEATURES

- Fully compatible with leading backmount frames.
- Accepts all leading backmount modules.
- Links with other frames in the Clipsal Datacomms high density portfolio.
- Metal covers available (100 and 250 pair frames only).

CUSTOMER BENEFITS

- Can be linked to pre-existing installations.
- Collaboration of voice and patch by exception.
- Consolidated voice and data applications with uniform aesthetics.

CATALOGUE NUMBER	DESCRIPTION
3100F100MDF	100 Pair Frame - Accommodates 10 Modules and 1 Label Holder
3100F250MDF	250 Pair Frame - Accommodates 25 Modules and 2 Label Holders
3100F540MDF	500 Pair Frame - Accommodates 50 Modules and 4 Label Holders
3100F100F	100 Pair Frame - Accommodates 10 Modules (no label holders). To be used in Conjunction with 3100C100MDF, TR Clear Cover and 3100EXIDF Enclosure.
31003U180MDF	180 Pair Rack Mount Frame 3RU
NOTE: Covers to suit, refer to page 11	

Category 3 Clip-on Frames

Clipsal's range of clip-on frames offer the flexibility of cylindrical mounting, allowing the installer and end-users to easily gain access to the rear of the modules. Fully compatible with leading voice manufacturer products, Clipsal clip-on frames can be interlocked with existing telecommunications infrastructure.

Clip-on frames are available for use as a main distribution frame (MDF), intermediate distribution frame (IDF) or floor distribution point (FDP).

DIMENSIONS

Product	A (width)	B (height)	C (depth)
3100F100MDFC	195mm	360mm	75mm
3100F250MDFC	195mm	710mm	75mm
3100F540MDFC	195mm	1319mm	75mm

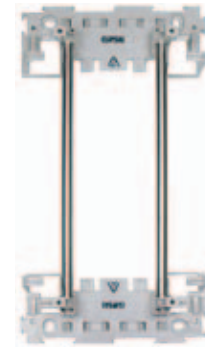

3100F100MDFC

PRODUCT FEATURES

- Fully compatible with leading clip-on style frames.
- Accepts all leading clip-on style modules.
- Links with other frames in the Clipsal Datacomms high density portfolio.
- Metal covers available (100 and 250 pair frames only).

CUSTOMER BENEFITS

- Can be linked to pre-existing installations.
- Compatible with leading voice manufacturer products.
- Collaboration of voice and patch by exception frames.
- Consolidated voice and data applications with uniform aesthetics.

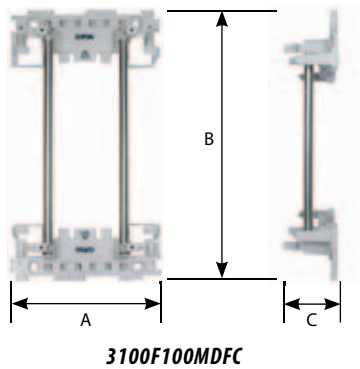

3100F100MDFC

CATALOGUE NUMBER	DESCRIPTION
3100F100MDFC	100 Pair Frame - Accommodates 10 Modules and 1 Label Holder
3100F250MDFC	250 Pair Frame - Accommodates 25 Modules and 2 Label Holders
3100F540MDFC	500 Pair Frame - Accommodates 50 Modules and 4 Label Holders

Category 3 Cable Management

The new cable management frames provide a simplified means of controlling patch cables between adjoining frames.

DIMENSIONS

Product	A (width)	B (height)	C (depth)
3100CMV100F	202mm	375mm	123mm
3100CMV250F	203mm	722mm	123mm
3100CMH	130mm	182mm	130mm



3100CMV250F

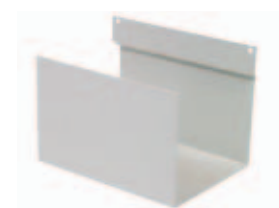

3100CMH

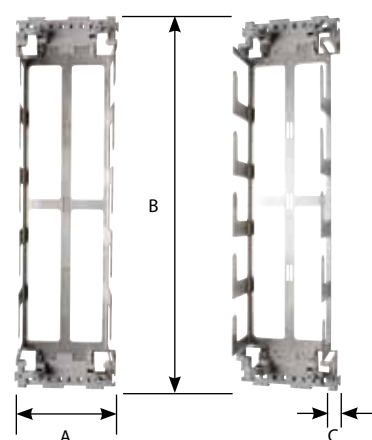

3100CMV250F

PRODUCT FEATURES

- Reduces the occurrence of tangled and messy patching.
- Allows easy routing of patch cords between frames.
- Can be interlocked with voice and patch by exception (PBE) frames.

CATALOGUE NUMBER	DESCRIPTION
3100CMV100F	Cable Management Frame - Vertical suits 100 Pair Voice and 104 Pair PBE Frames
3100CMV250F	Cable Management Frame - Vertical suits 250 Pair Voice and 280 Pair PBE Frames
3100CMH	Cable Management Trough - Horizontal

Category 3 Frame Covers

The Clipsal range of frame covers are a versatile means of providing mechanical protection for all frames, including voice and patch by exception. These products feature top, bottom and side knock-outs for ease of cable entry and/or exit. For additional security, all metal covers incorporate a key lock.

The clear security cover features a transparent finish providing immediate visual access to the telecommunication installation (no lock on clear cover).

DIMENSIONS

Product	A (width)	B (height)	C (depth)
3100C100MDF	202mm	375mm	123mm
3100C250MDF	203mm	722mm	123mm
3100C100MDF,TR	125mm	230mm	74mm



3100C100MDF



3100C100MDF,TR

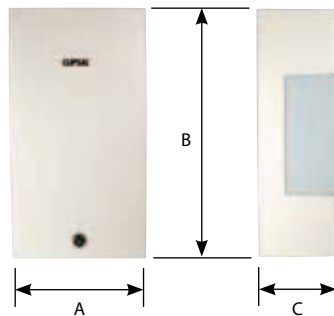

3100C100MDF

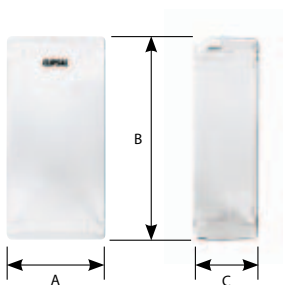

3100C100MDF,TR

PRODUCT FEATURES

METAL COVER

- 3100C100MDF suits 100 pair voice frame and 104 pair patch by exception frames.
- 3100C250MDF suits 250 pair voice frame and 280 pair patch by exception frames.
- Metal construction.
- Removable cable entries top, bottom and both sides.
- Key lock included (metal covers only).

CLEAR COVER

- Immediate visual inspection.
- Ideal for defence applications.
- Suits only 3100F100F voice frames.

CUSTOMER BENEFITS

- Uniform aesthetics for consolidated voice and data solutions.
- Metal covers provide excellent mechanical protection.
- Key locks secure installations from interference.
- Clear cover allow users to instantly inspect for tampering.

CATALOGUE NUMBER	DESCRIPTION
3100C100MDF	100 Pair Frame Cover with Key Lock and Removable Entries
3100C250MDF	250 Pair Frame Cover with Key Lock and Removable Entries
3100C100MDF,TR	100 Pair Frame Cover (Clear) suits 3100F100F Only

Category 3 Enclosures Surface Mount

The Clipsal range of voice enclosures incorporate backmount frames that are constructed of a sturdy hard plastic. Clipsal offer a 10 pair and 20 pair loaded product in a 30 pair enclosure to allow maximum working space for the installer.

These products can be used as either an intermediate distribution frame (IDF) or as a final distribution point (FDP).

DIMENSIONS

Product	A (width)	B (height)	C (depth)
3100E30IDF	114mm	150mm	55mm
3100E50IDF	160mm	210mm	90mm
3100E100IDF	210mm	319mm	123mm

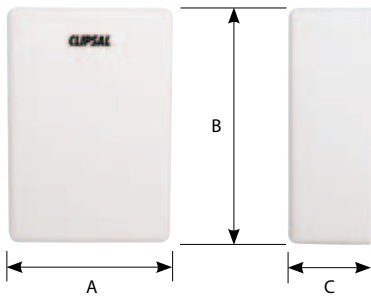

3100E30IDF



3100E30IDF

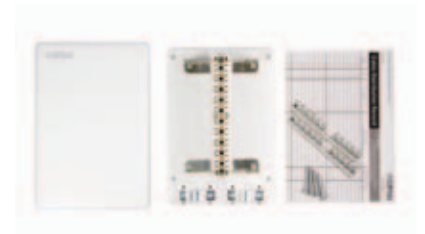

3100E10IDFL

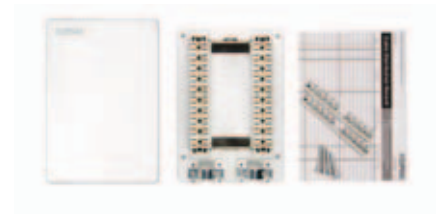

3100E20IDFL

PRODUCT FEATURES

30 PAIR ENCLOSURE

- Cable sheath locking clamps.
- Snap-on cover.
- Suitable for various environments.
- Accepts all leading backmount modules.

50 AND 100 PAIR ENCLOSURE

- Top and bottom jumper rings.
- Screw-lock covers.
- Includes earth terminal.
- Removable plastic cable entries on top, bottom and both sides.
- Rear access.
- Accepts all leading backmount modules.

LOADED ENCLOSURES

- 30 pair enclosure with 1 x 10 pair module or 2 x 10 pair modules.

CATALOGUE NUMBER	DESCRIPTION
3100E30IDF	30 Pair Enclosure - Backmount Style
3100E10IDFL	30 Pair Enclosure with 1 x 10 Pair Module - Backmount Style
3100E20IDFL	30 Pair Enclosure with 2 x 10 Pair Modules - Backmount Style
3100E50IDF	50 Pair Enclosure - Backmount Style
3100E100IDF	100 Pair Enclosure - Backmount Style

Category 3 Enclosures Flush Mount and Weatherproof

The 50 pair outdoor enclosure features an IP54 rating, ensuring that the telecommunication system is protected from dust, moisture and other potential contaminants. Clipsal's flush mount metal enclosure is a robust product with a low profile for confined spaces (internal frame not included with flush mount product).

These products can be used as either an intermediate distribution frame (IDF) or as a final distribution point (FDP). The outdoor enclosure is suitable for main distribution frame (MDF) applications.

DIMENSIONS

Product	A	B	C	D	E	F
3100EXIDF	273mm	342mm	10mm	55mm	150mm	114mm
3100E50IDFIP	190mm	220mm	100mm	NA	NA	NA

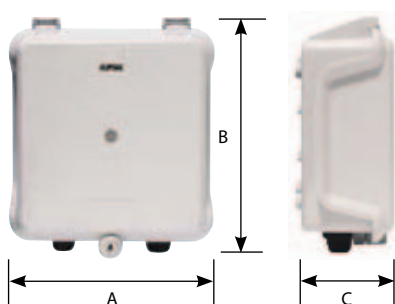

3100E50IDFIP

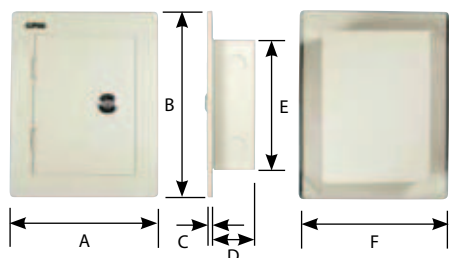

3100EXIDF



3100EXIDF



3100E50IDFIP

PRODUCT FEATURES

METAL FLUSH MOUNT ENCLOSURE

- Suits 3100F100F and 3100E30IDF frame.
- Key lock included.
- Wall mountable.

50 PAIR IP RATED ENCLOSURE

- IP54 rating for external applications.
- Accepts all leading backmount modules.
- Key lock included.

CATALOGUE NUMBER	DESCRIPTION
3100EXIDF	Metal Flush Mount Enclosure (frame not included)
3100E50IDFIP	50 Pair IP54 Rated Enclosure - Backmount Style

Category 3 Accessories

Clipsal also offers a range of accessories that complement the voice portfolio. The IDC punchdown tool provides an efficient and effective means of terminating conductors to the modules. Overvoltage magazines and arrestors extend protection for your voice infrastructure against possible lightning strikes or power surges.

ELECTRICAL SPECIFICATIONS

10 Pair Overvoltage Magazine	
Housing/Base	PBT/PBT UL94V-0
Contacts	Phosphor bronze (0.5mm)
Plating	Silver (20µ) over nickel
Housing Colour	Grey



3100A230/1



3100M10/3



3100RJA5V

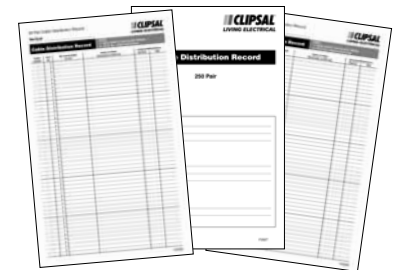

3100RB50, 3100RB250, 3100RB1000

PRODUCT FEATURES

- Punchdown tool provides efficient and effective termination.
- Overvoltage magazine secures directly onto disconnection/connection modules.
- Arrestors provide protection against potential electrical damage.

CATALOGUE NUMBER	DESCRIPTION
3100A230/1	3 Pole Arrestor, 230V - 10A/10kVA
3100M10/3	Overvoltage Magazine - 10 Pair Suits 3 Pole Arrestor
3100RJA5V	IDC Termination Tool
3100RB50	Cable Distribution Record Book 50 Pair (10 per pack) - 275mm (h) x 171mm (w)
3100RB250	Cable Distribution Record Book 250 Pair (5 per pack) - 275mm (h) x 171mm (w)
3100RB1000	Cable Distribution Record Book 1000 Pair (1 per pack) - 275mm (h) x 171mm (w)

Category 3 Jumper Wire

CONSTRUCTION

Two wire 0.5mm plain copper conductor, red and white or green and white, PVC insulated, twisted jumper wire.

ELECTRICAL CHARACTERISTICS

Conductor Resistance (max)	94.5 Ohm/km at 20°C
Insulated Resistance (min)	1000 MΩ/km



Product	No. of Pairs (mm)	Conductor Size (mm)	AWG	Reel Length (mm)	Approx Overall Diameter (mm)
2T2CIRW5	1	0.5	24	250	1.84
2T2CIGW5	1	0.5	24	250	1.84

CATALOGUE NUMBER	DESCRIPTION
2T2CIRW5	2 Wire 0.5mm Twisted Jumper Wire Red/White
2T2CIGW5	2 Wire 0.5mm Twisted Jumper Wire Green/White

Telephone Internal Cable Colour Codes

10 TO 100 PAIR CABLES INTERNAL TELEPHONE CABLE COLOUR CODES (EXCLUDING 25 PAIR - SEE TABLE BELOW)

Pair Number	A Leg (L+)	B Leg (L-)	Pair Range	Binder Colour
1	White	Blue	1-10	Blue-White
2	White	Orange	11-20	Orange-White
3	White	Green	21-30	Green-White
4	White	Brown	31-40	Brown-White
5	White	Grey	41-50	Grey-White
6	Red	Blue	51-60	Blue-Blue
7	Red	Orange	61-70	Orange-Orange
8	Red	Green	71-80	Green-Green
9	Red	Brown	81-90	Brown-Brown
10	Red	Grey	91-100	Grey-Grey

Construction: 10 pair units

25 PAIR INTERNAL TELEPHONE CABLE COLOUR CODES

Pair Number	Mate	Colour	Pair Number	Mate	Colour
1	White	Blue	14	Black	Brown
2	White	Orange	15	Black	Grey
3	White	Green	16	Yellow	Blue
4	White	Brown	17	Yellow	Orange
5	White	Grey	18	Yellow	Green
6	Red	Blue	19	Yellow	Brown
7	Red	Orange	20	Yellow	Grey
8	Red	Green	21	Violet	Blue
9	Red	Brown	22	Violet	Orange
10	Red	Grey	23	Violet	Green
11	Black	Blue	24	Violet	Brown
12	Black	Orange	25	Violet	Grey
13	Black	Green			

Construction: 2 x 10 pair units and 1 x 5 pair units

Telephone External Cable Colour Codes

10 TO 100 PAIR CABLES EXTERNAL TELEPHONE CABLE COLOUR CODES

Pair Number	A Leg (L+)	B Leg (L-)
1	White	Blue
2	White	Orange
3	White	Green
4	White	Brown
5	White	Grey
6	Red	Blue
7	Red	Orange
8	Red	Green
9	Red	Brown
10	Red	Grey

Pair Range	Binder Colour
1-10	Blue
11-20	Orange
21-30	Green
31-40	Brown
41-50	Grey
51-60	Blue-White
61-70	Orange-White
71-80	Green-White
81-90	Brown-White
91-100	Grey-White

Construction: 10 pair units

Internal Telephone Cables

Plain annealed copper conductors, solid polyethylene insulated, twisted pair, unit construction, taped and PVC overall sheathed cable. Designed for use within telephone exchanges, commercial switchboards and interconnecting wiring systems. These cables have been upgraded to Category 3, 100Ω balanced, suitable for Local Area Network (LAN) cabling (up to 16 Mhz). Data-grade UTP, capable of supporting transmission rates of up to 16Mbps. Cable is suitable for 100 base T4, IEEE 802.3 and 4 Mbps token ring systems.

CONSTRUCTION

Conductor	Plain annealed copper - 0.5mm diameter
Insulation	Solid polyethylene

PAIR IDENTIFICATION (2 PAIR)

Pair 1	White - Blue
Pair 2	Black - Red

PAIR IDENTIFICATION (3 PAIR)

Pair 1	White - Blue
Pair 2	White - Orange
Pair 3	White - Green

ELECTRICAL CHARACTERISTICS

DC Resistance [Ω/100m]	9.5 maximum
Resistance Unbalance[%]	3.0 maximum
Characteristic Impedance [Ω]	100±15 @ 1-20 Mhz
Mutual Capacitance [nF/100]	5.6 maximum
Capacitance Unbalance [Pf/100] Pair To Earth @ 0.8 Or 1 KHz:	340 maximum

Note: All electrical characteristics are given at 20°C.

ATTENUATION AND NEAR END CROSSTALK (NEXT)

Frequency (NHZ)	Max. Attenuation (db/100m)	Min. PR-PR NEXT (db/100m)
0.064	0.9	N/A
0.256	1.3	N/A
0.512	1.8	N/A
0.772	2.2	43
1	2.6	41
4	5.6	32
10	9.8	26
16	13.1	23

SHEATH: PVC 75°C

SHEATH COLOUR: Cream

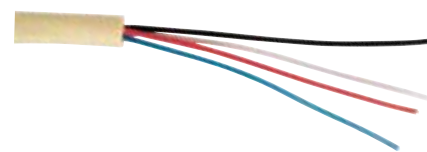

2T2PIPV3B

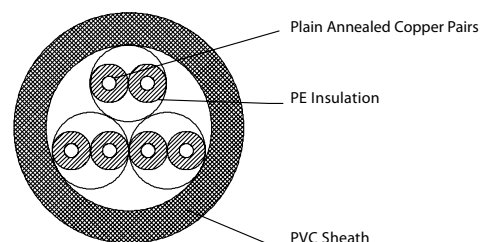

3 Pair Cable

CATALOGUE NUMBER	DESCRIPTION
2T2PIPV3B	Internal Telephone 1/0.50, 2 Pair - 305 Box
2T3PIPV3B	Internal Telephone 1/0.50, 3 Pair - 305 Box

Internal Telephone Cables

Plain annealed copper conductors, solid polyethylene insulated, twisted pair, unit construction, taped and PVC overall sheathed cable. Designed for use within telephone exchanges, commercial switchboards and interconnecting wiring systems. These cables have been upgraded to Category 3, 100Ω balanced, suitable for Local Area Network (LAN) cabling (up to 16 MHz). Data-grade UTP, capable of supporting transmission rates of up to 16Mbps. Cable is suitable for 100 base T4, IEEE 802.3 and 4 Mbps token ring systems.

SPECIFICATIONS

AS/ACIF S008 and ISO/IEC 11801, AS/NZS 3080

ELECTRICAL CHARACTERISTICS

DC Resistance [$\Omega/100m$]	9.5 maximum
Resistance Unbalance[%]	3.0 maximum
Characteristic Impedance [Ω]	100±15 @ 1-20 MHz
Mutual Capacitance [nF/100]	5.6 maximum
Capacitance Unbalance Pf/100] Pair To Earth @ 0.8 Or 1 KHz:	340 maximum

Note: All electrical characteristics are given at 20°C.

MECHANICAL CHARACTERISTICS

Mechanical / Physical Performance	Pair Count							
	2	3	6	10	20	25	50	100
Diameter [mm] (nominal)	3.9	4.9	6.8	7.6	9.4	10.6	14.3	19.1
Mass [kg/km] (nominal)	21	29	52	70	122	148	275	520
Minimum Bending Radius - Full Load [mm]	40	50	70	80	95	275	145	190
Maximum Tensile Strength - Short Term [kn]	75	110	225	370	750	900	1800	3700
Operating Temperature Range [°C]	-20 to +60							

ATTENUATION AND NEAR END CROSSTALK (NEXT)

Frequency (MHz)	Max. Attenuation (db/100m)	Min. PR-PR NEXT (db/100m)	Frequency (MHz)	Max. Attenuation (db/100m)	Min. PR-PR NEXT (db/100m)
0.064	0.9	N/A	1	2.6	41
0.256	1.3	N/A	4	5.6	32
0.512	1.8	N/A	10	9.8	26
0.772	2.2	43	16	13.1	23

CONSTRUCTION

Conductor	Plain annealed copper - 0.5mm diameter
Insulation	Solid polyethylene

SHEATH: PVC 75°C

SHEATH COLOUR: Cream

PAIR COLOUR CODE: Refer to page 16

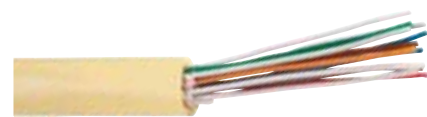

2T6PIPV

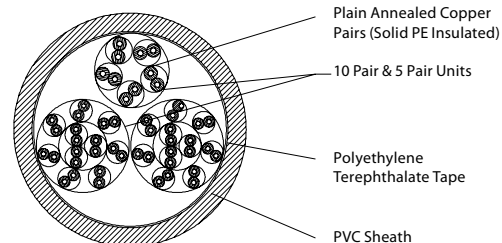

25 Pair Cable Shown

CATALOGUE NUMBER	DESCRIPTION
2T6PIPV	Internal Telephone 1/0.50, 6 Pair
2T10PIPV	Internal Telephone 1/0.50, 10 Pair
2T20PIPV	Internal Telephone 1/0.50, 20 Pair
2T25PIPV	Internal Telephone 1/0.50, 25 Pair
2T50PIPV	Internal Telephone 1/0.50, 50 Pair
2T100PIPV	Internal Telephone 1/0.50, 100 Pair

Jelly Filled External Lead - In Cable

Cable consists of 2 pairs, 0.40mm diameter, plain annealed copper conductors, solid polyethylene insulated, twisted quad, jelly filled interstices and overall polyethylene sheathed.

SPECIFICATIONS

AS/ACIFTS008, AS/NZS1125 and AS1049 .1 & .2

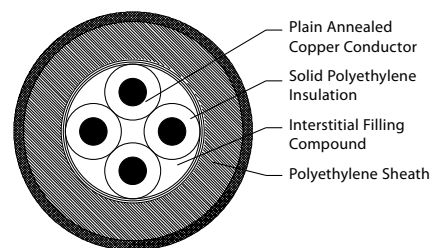

2T2POJPE4

CONSTRUCTION

Conductor	Plain annealed copper - 0.40mm
Insulation	Solid polyethylene
Cabling Element	Quad
Water Blocking	Petroleum jelly (Interstices)
Sheath	Polyethylene (UV Stabilised)
Jacket	Polyethylene (UV Stabilised) - Black

ELECTRICAL CHARACTERISTICS

Maximum Conductor Resistance [Ω /km]	139.3
Minimum Insulation Resistance (M Ω /km)	20,000
Maximum Mutual Capacitance [nF/km]	49
Maximum Capacitance Unbalance (corrected to 500m length) - pair to pair (pF)	500

MECHANICAL / PHYSICAL CHARACTERISTICS

Diameter [mm] (nominal)	4.6
Mass [kg/km] (nominal)	40
Minimum Bending Radius - Full Load [mm]	50
Maximum Tensile Strength - Short Term [N]	50
Operating Temperature [$^{\circ}$ C]	-10 to +70

PAIR COLOUR CODE: Refer to page 17.

CATALOGUE NUMBER	DESCRIPTION
2T2POJPE4	0.40mm Jelly Filled Polyethylene Jacket, 2 Pair

Jelly Filled External Lead - In Cable

Cable consists of 2 pairs, 0.64mm diameter, plain annealed copper conductors, solid polyethylene insulated, twisted quad, jelly filled interstices, polyethylene sheathed and nylon jacketed.

SPECIFICATIONS

AS/ACIFTS008, AS/NZS1125 and AS1049 .1 & .2

CONSTRUCTION

Conductor	Plain annealed copper - 0.64mm
Insulation	Solid polyethylene
Cabling Element	Quad
Water Blocking	Petroleum jelly (Interstices)
Sheath	Polyethylene (UV Stabilised)
Jacket	Nylon (UV Stabilised) - Black

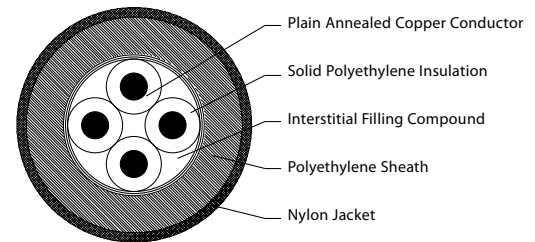

2T2POJN6

ELECTRICAL CHARACTERISTICS (0.64 mm)

Maximum Conductor Resistance [Ω /km]	56.4
Minimum Insulation Resistance (M Ω /km)	10,000
Maximum Mutual Capacitance [nF/km]	49
Maximum Capacitance Unbalance (corrected to 500m length) - pair to pair (pF)	500

MECHANICAL / PHYSICAL CHARACTERISTICS (0.64 mm)

Diameter [mm] (nominal)	6.5
Mass [kg/km] (nominal):	40
Minimum Bending Radius - Full Load [mm]	65
Maximum Tensile Strength - Short Term [kn]	125
Operating Temperature [$^{\circ}$ C]	-10 to +70

PAIR COLOUR CODE: Refer to page 17.

CATALOGUE NUMBER	DESCRIPTION
2T2POJN6	0.64mm Jelly Filled Poly/Nylon Jacket, 2 Pair

Jelly Filled External

Cable consists of up to 100 pairs, 0.40mm diameter, plain annealed copper conductors, solid polyethylene insulated, twisted quad, jelly filled interstices, polyethylene sheathed and polyethylene jacketed.



2T10POJPP4

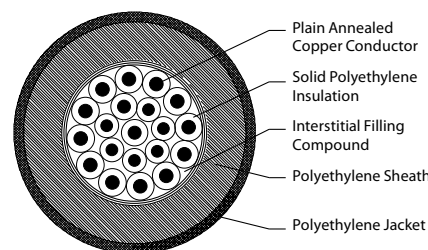

10 Pair Cable

SPECIFICATIONS

AS/ACIFTS008, AS/NZS1125 and AS1049.1 & .2

CONSTRUCTION

Conductor	Plain annealed copper - 0.40mm
Insulation	Solid polyethylene
Cabling Element	Quad
Water Blocking	Petroleum jelly (Interstices)
Sheath	Polyethylene (UV Stabilised)
Jacket	Polythylene (UV Stabilised) - Black

ELECTRICAL CHARACTERISTICS

Maximum Conductor Resistance (Ω /km)	139.3
Minimum Insulation Resistance (M Ω km)	20,000
Maximum Mutual Capacitance (nF/km)	49
Max. Capacitance Unbalance (Corrected to 500m length) Pair to Pair (pF)	500

MECHANICAL / PHYSICAL CHARACTERISTICS

	Pair Count			
	10	30	50	100
Diameter [mm] (nominal)	7.5	11.5	14	19.1
Mass [kg/km] (nominal)	60	150	230	440
Minimum Bending Radius - Full Load [mm]	120	185	225	305
Maximum Tensile Strength - Short Term [kN]	240	720	1200	2400
Operating Temperature Range [°C]	-10 to +70			

PAIR COLOUR CODE: Refer to page 17.

CATALOGUE NUMBER	DESCRIPTION
2T10POJPP4	0.40mm Jelly Filled Polythylene Jacket, 10 Pair
2T30POJPP4	0.40mm Jelly Filled Polythylene Jacket, 30 Pair
2T50POJPP4	0.40mm Jelly Filled Polythylene Jacket, 50 Pair
2T100POJPP4	0.40mm Jelly Filled Polythylene Jacket, 100 Pair

Jelly Filled External

Cable consists of up to 100 pairs, 0.64mm diameter, plain annealed copper conductors, cellular polyethylene insulated, bunched into 10 pairs unit, units laid up, jelly filled interstices, taped, moisture barriered, polyethylene overall sheathed and nylon jacketed.

SPECIFICATIONS

AS/ACIF S008, AS/NZS1125 and AS1049 .1 & .2

CONSTRUCTION

Conductor	Plain annealed copper 0.64mm
Insulation	Cellular polyethylene
Cabling Element	Twisted pair
Water Blocking	Petroleum jelly (Interstices)
Wrapping	Polyethylene terephthalate or paper tape
Moisture Barrier	Aluminium/Polyethylene laminated tape
Sheath	Polyethylene (UV Stabilised)
Hard Jacket	Nylon (UV Stabilised)

ELECTRICAL CHARACTERISTICS

Maximum Conductor Resistance (Ω/km)	56.4
Minimum Insulation Resistance (MΩkm)	20,000
Maximum Mutual Capacitance (nF/km)	49
Maximum Capacitance Unbalance (corrected to 500m length) pair to pair (pF)	150

MECHANICAL / PHYSICAL PERFORMANCE

	Pair Count			
	10	30	50	100
Diameter [mm] (nominal)	11.6	17.3	21.6	27.0
Mass [kg/km] (nominal)	155	365	580	999
Minimum Bending Radius - Full Load [mm]	230	340	430	540
Maximum Tensile Strength - Short Term [N]	600	1800	3100	6200
Operating Temperature Range [°C]	-10 to +70			

PAIR COLOUR CODE: Refer to page 17.



2T10POJPEBN6

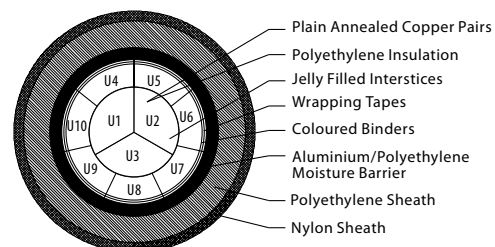

100 Pair Cable

CATALOGUE NUMBER	DESCRIPTION
2T10POJPEBN6	0.64mm Jelly Filled Moisture Barrier (Screened) Nylon Jacket, 10 Pair
2T30POJPEBN6	0.64mm Jelly Filled Moisture Barrier (Screened) Nylon Jacket, 30 Pair
2T50POJPEBN6	0.64mm Jelly Filled Moisture Barrier (Screened) Nylon Jacket, 50 Pair
2T100POJPEBN6	0.64mm Jelly Filled Moisture Barrier (Screened) Nylon Jacket, 100 Pair

Jelly Filled External - Nylon Jacket

Cable consists of up to 100 pairs, 0.64mm diameter, plain annealed copper conductors, cellular polyethylene insulated, twisted quad, jelly filled interstices, polyethylene sheathed and nylon jacketed.

This cable is termite and rodent resistant with the nylon jacket protection.

SPECIFICATIONS

AS/ACIF TS008, AS/NZS1125 and AS1049 .1 & .2

CONSTRUCTION

Conductor	Plain annealed copper 0.64mm
Insulation	Cellular polyethylene
Cabling Element	Quad
Water Blocking	Petroleum jelly (Intertices)
Sheath	Polyethylene (UV Stabilised)
Jacket	Nylon (UV Stabilised) - Black

ELECTRICAL CHARACTERISTICS

Maximum Conductor Resistance (Ω/km)	56.4
Minimum Insulation Resistance (MΩkm)	10,000
Maximum Mutual Capacitance (nF/km)	49
Maximum Capacitance Unbalance (corrected to 500m length) pair to pair (pF)	500

MECHANICAL / PHYSICAL CHARACTERISTICS

	Pair Count				
	10	20	30	50	100
Diameter [mm] (nominal)	10.7	14.2	16.4	20.9	28
Mass [kg/km] (nominal)	125	230	315	516	965
Minimum Bending Radius - Full Load [mm]	215	285	330	420	560
Maximum Tensile Strength - Short Term [N]	600	1200	180	3100	6200
Operating Temperature Range [°C]	-10 to +70				

PAIR COLOUR CODE: Refer to page 17.



2T10POJPN6

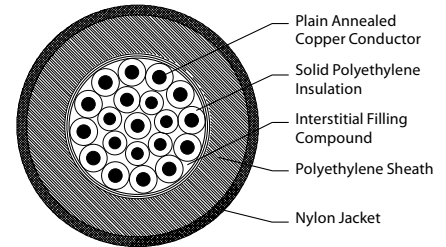

10 Pair Cable

CATALOGUE NUMBER	DESCRIPTION
2T10POJPN6	0.64mm Jelly Filled Nylon Jacket, 10 Pair
2T30POJPN6	0.64mm Jelly Filled Nylon Jacket, 30 Pair
2T50POJPN6	0.64mm Jelly Filled Nylon Jacket, 50 Pair
2T100POJPN6	0.64mm Jelly Filled Nylon Jacket, 100 Pair



CATEGORY 5e UTP RJ45 SOLUTION

Patch Cords
Modular Jacks
Keystone Jacks
Shuttered Modular Jacks
Shuttered Keystone Jacks
Patch Panels
Patch Panel Labels
Cable
Cable Management
Side Rings
MUTOs
Surface Mount Blocks

Category 5e UTP RJ45 Solution

The Clipsal Category 5e UTP solution has stood the test of time for many years, and is still an ideal offer for a business, school or home requiring bandwidth up to 155 Mhz. The system is capable of supporting applications such as 155Mb/s ATM, Gigabit Ethernet, 622Mb/s ATM and others.

This solution includes cable, patch panels, patch cables, modular jacks as well as face plates and cable management. It offers Class D performance and excellent headroom as indicated in the performance specifications. The product is UL listed and certificates are available on request. The Clipsal Lifetime Warranty is available upon application.

Clipsal Category 5e Patch Cord

The Clipsal Category 5e patch cord is a superior product, delivering the best network performance when used in conjunction with other Clipsal Category 5e products.

The patch cord is constructed of high grade cable and quality RJ45 plugs. The RJ45 plugs are provided with a fully moulded boot and a moulded insert to ensure pair integrity. The fully moulded boot offers excellent strain relief, ensuring that performance is not degraded when using the patch cord.

Patch cords are available in multiple colours to help with circuit identification in the cabinet/rack.



RJ5/10PL, BU

TRANSMISSION SPECIFICATIONS

@100MHZ	Product Specification	Category 5e Standard
Crosstalk (-dB) - 2M	35.3	35.0
Crosstalk (-dB) - 5M	35.1	34.7
Crosstalk (-dB) - 10M	34.8	34.5
Return Loss (- dB)	20.0	18.0

MECHANICAL CHARACTERISTICS OF CABLE

Cable	
Pair Count	4 pair individually colour coded with filler and PVC jacket
Sequence	Wiring sequences in 568 A
Durability	1,000 mating cycles
RJ45 Plug	Polycarbonate, FCC part 68 subpart F, UL 94V-0
Plug Boot	PVC
Contact Material	Phosphor bronze with 50 micro-inches gold over 100 micro-inches nickel
Electrical	
Dielectric Strength	100V RMS at 60Hz for 1 minute
Voltage Rating	150V a.c. maximum
Current Rating	1.5A maximum
Insulation	1MΩ maximum
Contact Resistance	10MΩ maximum

LINE DRAWING

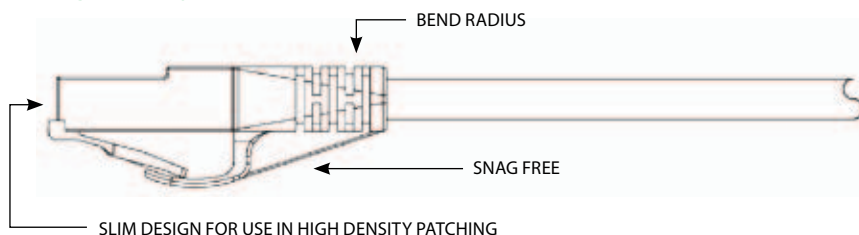

PRODUCT FEATURES

- Category 5e compliant to AS/NZS 3080: 2003 Class D.
- Moulded RJ45 plugs ensure stable performance.
- UL CMR fire rated jacket.
- Strain relief boot.
- Snag free design.

CUSTOMER BENEFITS

- Standards compliant.
- The fully moulded boot and insert not only ensures pair integrity but also provides enhanced strain relief during installations or moves.
- Multiple colours allow for easier circuit identification and administration.

CATALOGUE NUMBER	DESCRIPTION
RJ5/05PL (XX)	Category 5e Modular Patch Cord, 0.5m
RJ5/10PL (XX)	Category 5e Modular Patch Cord, 1.0m
RJ5/15PL (XX)	Category 5e Modular Patch Cord, 1.5m
RJ5/20PL (XX)	Category 5e Modular Patch Cord, 2.0m
RJ5/30PL (XX)	Category 5e Modular Patch Cord, 3.0m
RJ5/50PL (XX)	Category 5e Modular Patch Cord, 5.0m
RJ5/100PL (XX)	Category 5e Modular Patch Cord, 10.0m
RJ88P	Category 5e RJ45 Plug, Suitable for Stranded Cable, Pack of 100

(XX) for Colours: White (WE), Black (BK), Blue (BU), Yellow (YL), Red (RD), Green (GR) and Grey (GY)

Clipsal Category 5e UTP Jacks Modular - Suits Clipsal Wall Plates



30RJ45SMA5, WE

These modular jacks are colour coded for both 568A and 568B standards. They are designed to be terminated using a 110 tool (Clipsal 110 tool recommended, TRJ45PDT). Clear wire retaining caps are supplied and can be used to provide additional cable strain relief.

DIMENSIONS

Product	A (height)	B (width)	C (depth)
30RJ45SMA5	23mm	23mm	35mm

COLOUR AVAILABILITY



ELECTRICAL CHARACTERISTICS

Dielectric Strength	1,000V RMS at 60Hz for 1 minute
Current Rating	1.5A maximum
Insulation Resistance	500MΩ minimum
Contact Resistance	2MΩ per contact
Temperature Range	-10°C to +60°C
Transmission Performance	Exceeds ISO/IEC 11801 Class D AS/NZS 3080:2003 Class D

MECHANICAL CHARACTERISTICS

Modular Connector	
RJ45 8-Pin Connector	FCC part 68, subpart F and IEC 60603-7 compliant
Durability	750 insertion cycles minimum
Material	Phosphor bronze with 50 micro-inches of gold over 100 micro-inches nickel plating
IDC Connector	
IDC Connector	Suitable insulation of 22 to 24 AWG (0.64 to 0.41mm)
Insulation Diameter (Wire)	0.70 - 1.60mm
Connector Material	Phosphor bronze with nickel plating
IDC Body and Cover Material	Fire-retardant UL 94V-0, plastic

PRODUCT FEATURES

- Fully compliant to AS/NZS 3080:2003, ISO/IEC 11801 2002 and ANSI/TIA/EIA-568-B Series Connecting Hardware Standards.
- Fits all Clipsal style wall plates.
- Flexible locking tabs for easy insertion/removal from the wall plate.
- Universal colour coding for 568A and 568B standards.
- Wire retaining cap.
- ACMA compliant.

CUSTOMER BENEFITS

- Available in various colours for easier circuit identification and administration.
- The modules can be easily removed for reuse.

CATALOGUE NUMBER	DESCRIPTION
30RJ45SMA5, (XX)	Category 5e UTP, RJ45 Connector, Suits Clipsal Wall Plates
30RJ5M5/10, (XX)	Category 5e UTP, RJ45 Connector, Suits Clipsal Wall Plates, 10 Pack (only available in White and Black)
(XX) for Colours: White (WE), Black (BK), Blue (BU), Yellow (YL), Red (RD), Green (GR), Soft Grey (SG), Cream (CM) and Desert Sand (DS)	

Clipsal Category 5e UTP Jacks Keystone



RJ45SMA5,WE

These modular jacks are colour coded for both 568A and 568B standards. They are designed to be terminated using a 110 tool (Clipsal 110 tool recommended, TRJ45PDT). Clear wire retaining caps are supplied and can be used to provide additional cable strain relief.

DIMENSIONS

Product	A (height)	B (width)	C (depth)
RJ45SMA5	22mm	15mm	36mm

COLOUR AVAILABILITY



PRODUCT FEATURES

- Fully compliant to AS/NZS 3080:2003, ISO/IEC 11801 2002 and ANSI/TIA/EIA-568-B. Series Connecting Hardware Standards.
- Universal colour coding for 568A and 568B standards.
- Wire retaining cap.
- ACMA compliant.

CUSTOMER BENEFITS

- Available in various colours for easier circuit identification and administration.

ELECTRICAL CHARACTERISTICS

Dielectric Strength	1,000V RMS at 60Hz for 1 minute
Current Rating	1.5A maximum
Insulation Resistance	500MΩ minimum
Contact Resistance	2MΩ per contact
Temperature Range	-10°C to +60°C
Transmission Performance	Exceeds ISO/IEC 11801 Class D AS/NZS 3080:2003 Class D

MECHANICAL CHARACTERISTICS

Modular Connector	
RJ45 8-Pin Connector	FCC part 68, subpart F and IEC 60603-7 compliant
Durability	750 insertion cycles minimum
Material	Phosphor bronze with 50 micro-inches of gold over 100 micro-inches nickel plating
IDC Connector	
IDC Connector	Suitable insulation of 22 to 24 AWG (0.64 to 0.41mm)
Insulation Diameter (Wire)	0.70 - 1.60mm
Connector Material	Phosphor bronze with nickel plating
IDC Body and Cover Material	Fire-retardant UL 94V-0, plastic

CATALOGUE NUMBER	DESCRIPTION
RJ45SMA5, (XX)	Category 5e UTP RJ45 Connector, Keystone
(XX) for Colours: White (WE) and Black (BK)	

Clipsal Category 5e UTP Jacks Shuttered Modular - Suits Clipsal Wall Plates



30RJ45SMA5SH,WE

These modular jacks are colour coded for both 568A and 568B standards. They are designed to be terminated using a 110 tool (Clipsal 110 tool recommended, TRJ45PDT). Clear wire retaining caps are supplied and can be used to provide additional cable strain relief.

DIMENSIONS

Product	A (height)	B (width)	C (depth)
30RJ45SMA5SH	23mm	23mm	35mm

COLOUR AVAILABILITY



ELECTRICAL CHARACTERISTICS

Dielectric Strength	1,000V RMS at 60Hz for 1 minute
Current Rating	1.5A maximum
Insulation Resistance	500MΩ minimum
Contact Resistance	2MΩ per contact
Temperature Range	-10°C to +60°C
Transmission Performance	Exceeds ISO/IEC 11801 Class D AS/NZS 3080:2003 Class D

MECHANICAL CHARACTERISTICS

Modular Connector

RJ45 8-Pin Connector	FCC part 68, subpart F and IEC 60603-7 compliant
Durability	750 insertion cycles minimum
Material	Phosphor bronze with 50 micro-inches of gold over 100 micro-inches nickel plating

IDC Connector

IDC Connector	Suitable insulation of 22 to 24 AWG (0.64 to 0.41mm)
Insulation Diameter (Wire)	0.70 - 1.60mm
Connector Material	Phosphor bronze with nickel plating
IDC Body and Cover Material	Fire-retardant UL 94V-0, plastic

PRODUCT FEATURES

- Fully compliant to AS/NZS 3080:2003, ISO/IEC 11801 2002 and ANSI/TIA/EIA-568-B. Series Connecting Hardware Standards.
- Fits all Clipsal style wall plates.
- Flexible locking tabs for easy insertion/removal from the wall plate.
- Universal colour coding for 568A and 568B standards.
- Wire retaining cap.
- ACMA compliant.
- IP22 rated.

CUSTOMER BENEFITS

- Available in various colours for easier circuit identification and administration.
- The modules can be easily removed for reuse.
- Prevents against accidental insertion; dust, spider webs, etc.
- Complies with ASIF009 regarding areas with small children.



IP22 Rated

- Prevents dust ingress.
- Protects against insect infestation.
- Deters foreign object insertion.

CATALOGUE NUMBER DESCRIPTION

30RJ45SMA5SH, (XX) Category 5e UTP RJ45 Connector, Shuttered, Suits Clipsal Wall Plates

(XX) for Colours: White (WE), Black (BK), Blue (BU), Yellow (YL), Red (RD), Green (GR), Soft Grey (SG) and Pink (PK)

Clipsal Category 5e UTP Jacks Shuttered Keystone



These modular jacks are colour coded for both 568A and 568B standards. They are designed to be terminated using a 110 tool (Clipsal 110 tool recommended, TRJ45PDT). Clear wire retaining caps are supplied and can be used to provide additional cable strain relief.

DIMENSIONS

Product	A (height)	B (width)	C (depth)
RJ45SMA5SH	22mm	15mm	36mm

COLOUR AVAILABILITY



ELECTRICAL CHARACTERISTICS

Dielectric Strength	1,000V RMS at 60Hz for 1 minute
Current Rating	1.5A maximum
Insulation Resistance	500MΩ minimum
Contact Resistance	2MΩ per contact
Temperature Range	-10°C to +60°C
Transmission Performance	Exceeds ISO/IEC 11801 Class D AS/NZS 3080:2003 Class D

MECHANICAL CHARACTERISTICS

Modular Connector

RJ45 8-Pin Connector	FCC part 68, subpart F and IEC 60603-7 compliant
Durability	750 insertion cycles minimum
Material	Phosphor bronze with 50 micro-inches of gold over 100 micro-inches nickel plating

IDC Connector

IDC Connector	Suitable insulation of 22 to 24 AWG (0.64 to 0.41mm)
Insulation Diameter (Wire)	0.70 - 1.60mm
Connector Material	Phosphor bronze with nickel plating
IDC Body and Cover Material	Fire-retardant UL 94V-0, plastic



RJ45SMA5SH,WE

PRODUCT FEATURES

- Fully compliant to AS/NZS 3080:2003, ISO/IEC 11801 2002 and ANSI/TIA/EIA-568-B. Series Connecting Hardware Standards.
- Universal colour coding for 568A and 568B standards.
- Wire retaining cap.
- ACMA compliant.
- IP22 rated.

CUSTOMER BENEFITS

- Available in various colours for easier circuit identification and administration.
- The modules can be easily removed for reuse.
- Prevents against accidental insertion; dust, spider webs, etc.

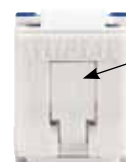

IP22 Rated

- Prevents dust ingress.
- Protects against insect infestation.
- Deters foreign object insertion.

CATALOGUE NUMBER DESCRIPTION

RJ45SMA5SH, (XX) Category 5e UTP RJ45 Connector, Shuttered, Keystone

(XX) for Colours: White (WE), Black (BK), Blue (BU), Yellow (YL), Red (RD), Green (GR) and Soft Grey (SG)

Clipsal Category 5e UTP 16 & 24 Port Patch Panels

The Clipsal patch panel range of products feature individual Category 5e modular jacks that are colour coded for both 568A and 568B standards and must be terminated using a 110 tool (Clipsal 110 tool recommended, TRJ45PDT). Clear wire retaining caps are supplied and can be used to provide additional cable strain relief.

The patch panel comprises three designation strip-holders with a label kit supplied. Rear cable management tray, velcro cable ties, cage nuts and screws are also provided with the product.

ELECTRICAL CHARACTERISTICS

Dielectric Strength	1,000V RMS at 60Hz for 1 minute
Current Rating	1.5A maximum
Insulation Resistance	10MΩ minimum
Contact Resistance	2MΩ per contact
Temperature Range	-10°C to +60°C
Transmission Performance	Exceeds ISO/IEC 11801 Class D AS/NZS 3080:2003 Class D

MECHANICAL CHARACTERISTICS

Modular Connector	
RJ45 8-Pin Connector	FCC part 68, subpart F and IEC 60603-7 compliant
Durability	750 insertion cycles minimum
Material	Phosphor bronze with 50 micro-inches of gold over 100 micro-inches nickel plating
IDC Connector	
IDC Connector	Suitable insulation of 22 to 24 AWG (0.64 to 0.41mm)
Insulation Diameter (Wire)	0.70 - 1.60mm
Connector Material	Phosphor bronze with nickel plating
IDC Body and Cover Material	Fire-retardant, UL 94V-0, plastic



RJ5A1/16PP



RJ5A1/24PP



RJ5/24PP

PRODUCT FEATURES

- Fully compliant to AS/NZS 3080:2003, ISO/IEC 11801 Edition 2 2002 and ANSI/TIA/EIA-568-B. Series Connecting Hardware Standards.
- Powder coated metal framework.
- Universal colour coding for 568A and 568B standards.
- Removable rear cable management tray.
- Compatible with standard 19" equipment frames.
- IDC termination using Clipsal 110 tool.
- Individual removable modular jacks.
- Wire retaining cap.
- ACMA compliant.

CUSTOMER BENEFITS

- Complete with all mounting and cable fixing hardware.
- Rear cable management tray is supplied loose, allowing the installer to fit after termination.
- The front labelling system provides a clear and efficient means of identifying circuits.
- Powder coated metal frame is robust and protects the patch panel from corrosion and scratching.

CATALOGUE NUMBER	DESCRIPTION
RJ5A1/16PP	Category 5e UTP, 16 Port Patch Panel
RJ5A1/24PP	Category 5e UTP, 24 Port Patch Panel
RJ5/16PP	Category 5e UTP, 16 Port Patch Panel, Actassi Range (to be released 2011)
RJ5/24PP	Category 5e UTP, 24 Port Patch Panel, Actassi Range (to be released 2011)
RJ5/6 CTWLS	Patch Panel Window Label Stickers, Suits Clipsal Category 5e and 6 (10 Sheets, 5 numbered and 5 blank)
RJ45SMA5,BK	Category 5e UTP Keystone Modular Jack (replacement jack suitable for patch panel)

Unloaded Configurable Patch Panel

The Clipsal unloaded configurable patch panel is a superior product, delivering the best multimedia connectivity when used in conjunction with Clipsal modular jacks.

The Clipsal unloaded configurable patch panel can be fully or partly loaded with Category 5e or Category 6 modular jacks or with any of the Clipsal 30 mech style adaptors. Panels are metal constructed and powder coated for protection against scratches and rust.

MECHANICAL CHARACTERISTICS

Panel Material	1.6mm mild steel, powder coated
----------------	--

DIMENSIONS

Product	Height	Width	Depth
RJ5H1/16PP	44mm	482mm	10mm

CONFIGURABLE PATCH PANEL OPTIONS

Catalogue Number	Description
30P	Removable Plug
30PID	ID Circuit Plug
30RJ45SMA5	Category 5e, 30 Mech Modular Jack
30RJ45SMA6	Category 6, 30 Mech Modular Jack
30RJ45SMA5SH	Category 5e, 30 Mech Modular Jack, Shuttered
30RJ45SMA6SH	Category 6, 30 Mech Modular Jack, Shuttered
30RJ64SM	6 Way, 4 Contact Socket Mechanism (RJ11)
30RJ64SMT	6 Way, 4 Contact Socket Mechanism Telephone (RJ11)
30RJ66SM	6 Way, 6 Contact Socket Mechanism (RJ12)
30RJ66SMT	6 Way, 6 Contact Socket Mechanism Telephone (RJ12)



RJ5H1/16PP

PRODUCT FEATURES

- Powder coated to provide protection against scratches and rust.
- Graphite Grey.
- Comes with cage nut sets for rack mounting.
- Accepts other 30 mech adaptors such as RJ45, 75Ω coax, etc.
- Compatible with standard 19" equipment.

CUSTOMER BENEFITS

- The powder coated metal provides protection from scratches whilst being installed and stops rust from forming, ensuring the full life of the product.
- The panel is designed to accept all 30 mech style adaptors and sockets.
- The panel is fully configurable, making it very cost effective.

Note:

This panel is not suitable for use with 30 mech electrical products (i.e. 30M, 30M15, 30MD, etc).

CATALOGUE NUMBER DESCRIPTION

RJ5H1/16PP	16 Port Unloaded Configurable Patch Panel
-------------------	---

Patch Panel Labels

To complement the range of Clipsal patch panels, Clipsal Datacomms have introduced window label stickers. This value-added product has been designed specifically for the following patch panels in the portfolio:

- RJ5A1/16PP
- RJ5A1/24PP
- RJ5/24PP
- RJ5/16PP.

The Clipsal patch panel window label stickers provide a professional finishing touch to any structured cabling system.

Each pack contains 10 A4 label sheets; five with small numbers on the left hand side (1 – 144) and five sheets with blank labels. There are 18 labels per sheet and each window label accommodates one block of eight data outlets. The stickers are finished in silver to match the front fascia of the patch panels. Most inkjet and laser printers will print on these labels.

Customers can download the printing software from clipsal.com, simply type in <http://www.clipsal.com/label> to take you to the product page and link to the software. The instructions found on the web page provide handy hints in formatting, printing and adhering the identification stickers.



RJ5/6CTWLS

A01	A02	A03	A04	A05	A06	A07	A08
A09	A10	A11	A12	A13	A14	A15	A16
A17	A18	A19	A20	A21	A22	A23	A24
B01	B02	B03	B04	B05	B06	B07	B08
B09	B10	B11	B12	B13	B14	B15	B16
B17	B18	B19	B20	B21	B22	B23	B24
C01	C02	C03	C04	C05	C06	C07	C08
C09	C10	C11	C12	C13	C14	C15	C16
C17	C18	C19	C20	C21	C22	C23	C24
D01	D02	D03	D04	D05	D06	D07	D08
D09	D10	D11	D12	D13	D14	D15	D16
D17	D18	D19	D20	D21	D22	D23	D24
E01	E02	E03	E04	E05	E06	E07	E08



CATALOGUE NUMBER DESCRIPTION

RJ5/6CTWLS Patch Panel Window Label Stickers, Suits Clipsal Category 5e and 6 (10 sheets, 5 numbered and 5 blank)

Clipsal Category 5e UTP Cable

Clipsal Category 5e 4 pair cable consists of 24 AWG (0.57mm) solid copper conductors, insulated with high-density polyethylene. The insulated conductors are tightly twisted into pairs and covered with PVC material.

The cable provides excellent high speed transmission. It is certified to 155MHz and supports applications such as 155Mb/s ATM, 622Mb/s ATM and IEEE 802.3 1,000 Base-T (Gigabit Ethernet) standard, using parallel transmission technology. This product is UL listed with a CM fire rating.

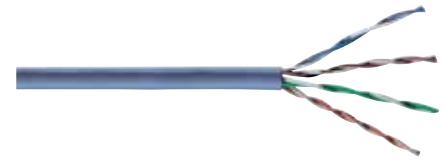

2D4P5IPV3B, BU

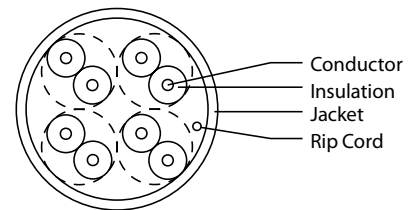

PHYSICAL SPECIFICATIONS

Rated Temperature (°C)	75
Product Standard Certification	UL File E 215065
Flammability Test	CM
Application	Horizontal wiring in LAN
Reference Standard	UL Subject 444, EIA/TIA568 & ISO/IEC 11801
Comply to RoHS Standard	Yes

CONSTRUCTION

Conductor	Solid bare copper (annealed)
Gauge (AWG)	24
Conductor Diameter Nom. (mm)	0.51
Insulation	HDPE
Average Thickness (mm)	0.18
Minimum Point Thickness (mm)	0.15
Insulation Diameter (±0.10mm)	0.87
Twisting Lay Length (mm) [See pair colour coding]	P1:13 ± 0.5 P2:21 ± 0.5 P3:15 ± 0.5 P4:17 ± 0.5
Cabling Lay Length (mm)	155 ± 5
Jacket	PVC
Average Thickness (±0.05mm)	0.58
Minimum Point Thickness (mm)	0.46
Outer Diameter (±0.2mm)	5
Rip Cord	YES

MECHANICAL CHARACTERISTICS

Test Object	Jacket
Test Material	PVC
Before Tensile Strength (Mpa)	≥13.8
Aging Elongation (%)	≥100
Aging Condition (°C x hrs)	100C x 240H
After Tensile Strength (Mpa)	≥85% of original
Aging Elongation (%)	≥50% of original
Cold Bend (-20 ± 2° C x 4hrs)	No crack
Bend Radius (mm)	50 (25 after install)

PAIR COLOUR CODING

Pair 1 (P1)	Blue - White/Blue
Pair 2 (P2)	Orange - White/Orange
Pair 3 (P3)	Green - White/Green
Pair 4 (P4)	Brown - White/Brown

ELECTRICAL CHARACTERISTICS

Frequency (MHz)	Return Loss (dB)	Attenuation (dB/100m)	ACR (dB)	Delay (ns/100m)
0.772	/	1.8	65.2	/
1	20.0	2.0	63.3	570.0
4	23.0	4.1	52.2	/
8	24.5	5.3	46.5	/
10	25.0	6.5	43.8	545.0
16	25.0	8.2	39.0	/
20	25.0	9.3	36.5	/
25	24.3	10.4	33.9	/
31.25	23.6	11.7	31.2	/
62.5	21.5	17.0	21.4	/
100	20.1	22.0	13.2	538.0

Frequency (MHz)	NEXT (dB)	PSNEXT (dB/100m)	ELFEXT (dB/100m)	PSELFEXT (dB/100m)
0.772	67.0	64.0	/	/
1	65.3	62.3	63.8	60.8
4	56.3	53.3	51.8	48.8
8	51.8	48.8	45.7	42.7
10	50.3	47.3	43.8	40.8
16	47.2	44.2	39.7	36.7
20	45.8	42.8	37.8	34.8
25	44.3	41.3	35.8	32.8
31.25	42.9	39.3	33.9	30.9
62.5	38.4	35.4	27.9	24.9
100	35.2	32.3	23.8	20.8

1.0-100.0MHz Input Impedance (Ohms)	100+/-15
1.0-250.0MHz Delay Skew (ns/100m)	<=45
Pair-to-ground Capacitance Unbalance (pF/100m)	330
Max. Conductor DC Resistance 20°C (Ohms/km)	93.8
Resistance Unbalance (%)	5
Nominal Velocity of Propagation (NVP,%)	69

CATALOGUE NUMBER	DESCRIPTION
2D4P5IPV3B, (XX)	Category 5e UTP, 4 Pair Cable, 24AWG, 305m
2D4P5IPV5B, BU	Category 5e UTP, 4 Pair Cable, 24AWG, 500m Box, (Blue only)

(XX) for Colours: Blue (BU), Yellow (YL), Red (RD), Green (GR) and Grey (GY)

Clipsal Cable Management Panel Deep and Shallow

The Clipsal cable management panels are a one rack unit (1RU) design for use in 19" rack environments, managing patch cords that are connected between patch panels and active switches. The product is recommended for mounting between every second row of patch panels/active switches.

The unique clips provide a quick and simple means of installing the panel in the rack or cabinet. The rings have been designed to facilitate easy insertion and removal of the patch leads, necessary in dynamic environments where moves and changes are required.

DIMENSIONS

Product	A (height)	B (width)	C (depth)
RJ1UCMPC	44mm	482mm	100mm
RJ1UCMPSC	44mm	482mm	70mm

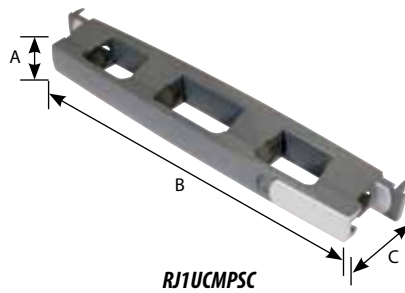
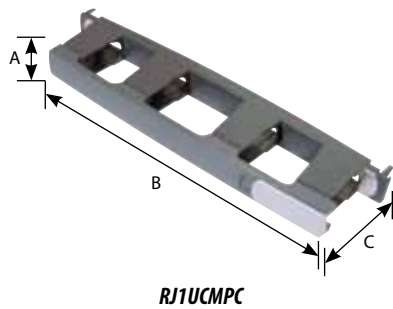

RJ1UCMPC



Rack clips for easy mounting



Reinforced cable rings

PRODUCT FEATURES

- Clip on cover (patented).
- Rack mount clips eliminate the need for cage nuts and screws.
- Cavities behind each ring provide additional space for cable slack.
- Additional depth on cable rings ensure compliance with minimum bend radius requirements.

CUSTOMER BENEFITS

- Quick product installation using rack mount clips.

CATALOGUE NUMBER	DESCRIPTION
RJ1UCMPC	1RU Cable Management Panel, Deep
RJ1UCMPSC	1RU Cable Management Panel, Shallow

Clipsal Side Rings

The side rings are typically used in frames or cabinets to provide vertical patch cord management. These rings have several features that make them stand out. The “ring and lock” design utilises proven plastic hinge technology to guide patch cords. These rings have unique teeth locks that are easy to open and snap back to lock tight again, should you need to open the rings.

The rings can be mounted with patch panels or directly onto the vertical panel mounts (VPM) of the equipment frame.

MECHANICAL CHARACTERISTICS

Test Object	Jacket
Ring Material	Polypropylene, Graphite Grey

DIMENSIONS

Product	A (height)	B (width)	C (depth)
RJ1HUSSR	42mm	43mm	65mm
RJ1HUDSR	42mm	43mm	130mm

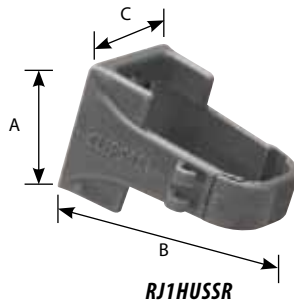
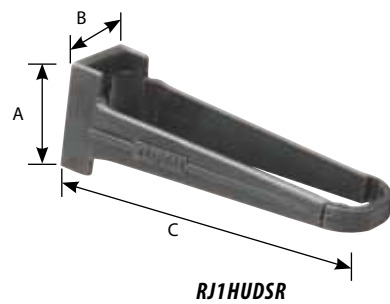

RJ1HUDSR



RJ1HUSSR

PRODUCT FEATURES

- Graphite Grey.
- Teeth locks that provide easy access and security for patch cords.
- Available in deep and shallow versions.

CUSTOMER BENEFITS

- The “ring and lock” design not only makes the loading and unloading of patch cords or cables easier, but also secures them in place. This keeps the cabinet neat and uncluttered. Circuit identification and administration for the customer is also far more efficient.
- The two ring depths enable the installer to manage the cabinet or rack better, depending on the amount of patch cords being used.

CATALOGUE NUMBER	DESCRIPTION
RJ1HUSSR	1RU Shallow Side Ring
RJ1HUDSR	1RU Deep Side Ring

MUTOS

MULTI USER TELECOMMUNICATION OUTLETS (MUTO)

Clipsal provides a range of MUTO options, which are ideal in situations where a number of terminals are required in the one area.

Floor outlet housing can also be used in desktop applications where up to 12 services are required, and they fit all standard Clipsal face plates.

All Clipsal 2000 Series wall plates will fit into the housing and surrounds of the MUTOs.



224/1



2000/3



2000H2



**Loaded 224/1
Floor Outlet**



Loaded Face Plate

CATALOGUE NUMBER	DESCRIPTION
224/1	Floor Outlet Housing for 2 Standard Plates, Can be used on Desktops
224/2	Floor Outlet Housing for 4 Standard Plates, Can be used on Desktops
2000/2	2 Gang Flush Surround, Curved Sides, Suits all 2000 Series Grids
2000/3	3 Gang Flush Surround, Curved Sides, Suits all 2000 Series Grids
2000/4	4 Gang Flush Surround, Curved Sides, Suits all 2000 Series Grids
2000H2	Horizontal 2 Gang Flush Surround, Curved Sides, Suits all 2000 Series Grids
2000H4	Horizontal 4 Gang Flush Surround, Curved Sides, Suits all 2000 Series Grids

Surface Mount Blocks

The Clipsal surface mount blocks are suitable for desk or wall mounting. The port sizes range from one through to six ports and can be accommodated side-by-side to give greater port counts if necessary. The keystone modular products snap into place, in the block, to provide quick installation. The blocks come with screws and double-sided tape to provide an alternative mounting option.

TECHNICAL SPECIFICATIONS

	Height	Width	Depth
1 Port	25.1mm	38.4mm	58mm
2 Port	25.1mm	62mm	58mm
4 Port	25.2mm	114.3mm	70mm
6 Port	35mm	170mm	110mm

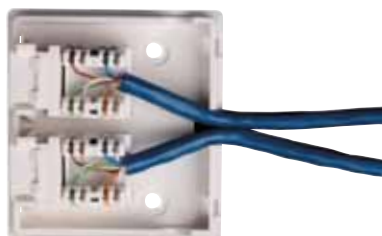

SMRJ45A5/1,WE



SMRJ45A5/2,WE



SMRJ45A5/4,WE



SMRJ45A5/6,WE

PRODUCT FEATURES

- Surface mounted on either wall or desk.
- Port labelling area provided.
- Category 5e connectors included.

CATALOGUE NUMBER	DESCRIPTION
SMRJ45A5/1,WE	Surface Mount Block, 1 Port, Category 5e RJ45, White (WE)
SMRJ45A5/2,WE	Surface Mount Block 2 Port Category 5e RJ45, White (WE)
SMRJ45A5/4,WE	Surface Mount Block 4 Port Category 5e RJ45, White (WE)
SMRJ45A5/6,WE	Surface Mount Block 6 Port Category 5e RJ45, White (WE)

CATEGORY 6 UTP RJ45 SOLUTION

Patch Cords
Modular Jacks
Keystone Jacks
Shuttered Modular Jacks
Shuttered Keystone Jacks
Patch Panels
Shuttered Patch Panels
Patch Panel Labels
Cable
Cable Management
Side Rings
MUTOs
Surface Mount Blocks

Category 6 UTP RJ45 Solution

The Clipsal Category 6 UTP solution provides the customer with a great value proposition. The system is designed to operate up to 250Mhz and offers a solution for horizontal cabling, as well as backbone cabling where required. The product utilises lead frame technology, which delivers reliability above other PCB product.

This solution includes cable, patch panels, patch cables and modular jacks, as well as face plates and cable management. It offers Class E performance and excellent headroom, as indicated in the specifications.

The product is UL listed and certificates are available on request. The Clipsal Lifetime Warranty is available upon application.

Clipsal Category 6 Patch Cords

The Clipsal Category 6 patch cord is a superior product, delivering the best network performance when used in conjunction with other Clipsal Category 6 products.

The patch cord is constructed of high grade cable and quality RJ45 plugs, and is designed to operate up to 250MHz. This enables it to operate successfully in a Category 6 environment.



RJ6/05PL, BU

TRANSMISSION SPECIFICATIONS

Parameter	Value (-dB)	Category 6 (-dB)
NEXT	55.1	≥54.0
Power Sum NEXT	52.0	≥54.0
FEXT	49.8	≥43.1
Power Sum FEXT	46.9	≥40.1
Attenuation	0.1	≤0.2
Return Loss	27.0	≥23.0

MECHANICAL CHARACTERISTICS

Cable	
Gauge (AWG)	23 AWG with PE insulation, CMR fire rated
Pair Count	4 pair individually colour coded with filler and PVC jacket
Sequence	Wiring sequence 568A
Durability	1000 mating cycles
RJ45 Plug	Polycarbonate, FCC part 68 subpart F, UL 94V-0
Plug Boot	PVC
Contact Material	Phosphor bronze with 50 micro-inches gold over 100 micro-inches nickel

ELECTRICAL

Dielectric Strength	1000V RMS at 60 Hz for 1 minute
Voltage Rating	150V a.c. maximum
Current Rating	1.5A maximum
Insulation	500MΩ minimum
Contact Resistance	10MΩ maximum

LINE DRAWING

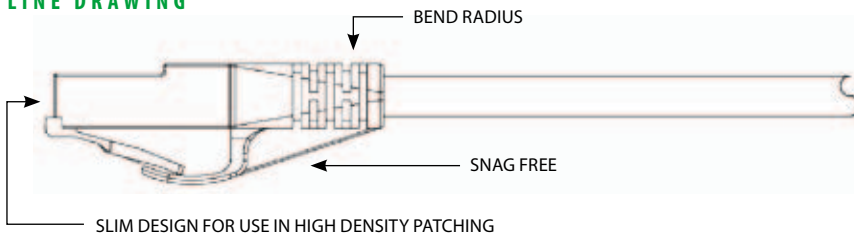

PRODUCT FEATURES

- Fully compliant to AS/NZS 3080:2003, ISO/IEC 11801 Edition 2 2002 and ANSI/TIA/EIA-568-B Series Connecting Hardware Standards.
- UL CMR fire rated jacketing.
- PE insulation on conductors.
- PVC outer jacket material.
- Available in multiple lengths.
- Backward compatible with Category 5e products.
- Strain relief boot.
- Snag free design.

CUSTOMER BENEFITS

- Standards compliant.
- Comes in various lengths to assist with better cable management.
- Multiple colours for easier circuit identification and administration.

CATALOGUE NUMBER	DESCRIPTION
RJ6/05PL (XX)	Category 6 Modular Patch Cord, 0.5m
RJ6/10PL (XX)	Category 6 Modular Patch Cord, 1m
RJ6/15PL (XX)	Category 6 Modular Patch Cord, 1.5m
RJ6/20PL (XX)	Category 6 Modular Patch Cord, 2m
RJ6/30PL (XX)	Category 6 Modular Patch Cord, 3m
RJ6/50PL (XX)	Category 6 Modular Patch Cord, 5m

(XX) for Colour: White (WE), Black (BK), Blue (BU), Yellow (YL), Red (RD), Green (GR) and Grey (GY)

Clipsal Category 6 UTP Jacks Modular - Suits Clipsal Wall Plates



30RJ45SMA6,WE

The Clipsal range of products is the next generation of data communication solutions. These modular jacks are colour coded for both 568A and 568B Standards. They are designed to be terminated using a 110 tool (Clipsal 110 tool recommended, TRJ45PDT). Clear wire retaining caps are supplied and can be used to provide additional cable strain relief.

DIMENSIONS

Product	A (height)	B (width)	C (depth)
30RJ45SMA6	23mm	23mm	35mm

COLOUR AVAILABILITY



ELECTRICAL CHARACTERISTICS

Dielectric Strength	1,000V RMS at 60Hz for 1 minute
Current Rating	1.5A maximum
Insulation Resistance	200MΩ minimum
Contact Resistance	1MΩ per contact
Temperature Range	-40° C to +70° C
Transmission Performance	ISO/IEC 11801 Class E AS/NZS 3080:2003 Class E

MECHANICAL CHARACTERISTICS

Modular Connector	
RJ45 8-Pin Connector	FCC part 68, subpart F and IEC 60603-7 compliant
Durability	750 insertion cycles minimum
Material	Phosphor bronze with 50 micro-inches of gold over 100 micro-inches nickel plating
IDC Connector	
IDC Connector	Suitable insulation of 22 to 24 AWG (0.64 to 0.41mm)
Insulation Diameter (Wire)	0.70 - 1.60mm
Connector Material	Phosphor bronze with nickel plating
IDC Body and Cover Material	Fire-retardant UL 94V-0, plastic

PRODUCT FEATURES

- Fully compliant to AS/NZS 3080:2003, ISO/IEC 11801 Edition 2 2002 and ANSI/TIA/EIA-568-B Series Connecting Hardware Standards.
- Backward compatible with Category 5e products.
- Flexible locking tabs.
- UL 94V-0 rated.
- Accepts solid 22-24 AWG diameter conductors.
- Universal colour coding for 568A and 568B standards.

CUSTOMER BENEFITS

- Various colours for easier circuit identification.
- Can be used in multi-user telecommunication outlets.
- Flexible locking tabs for easy removal from wall plates.
- Clear IDC caps allow for termination verification and assist in cable retention.

CATALOGUE NUMBER DESCRIPTION

30RJ45SMA6 (XX) Category 6 UTP RJ45 Connector, suits Clipsal Wall Plates

(XX) for Colour: White (WE), Black (BK), Blue (BU), Yellow (YL), Red (RD), Green (GR), Soft Grey (SG) and Cream (CR)

Clipsal Category 6 UTP Jacks Keystone

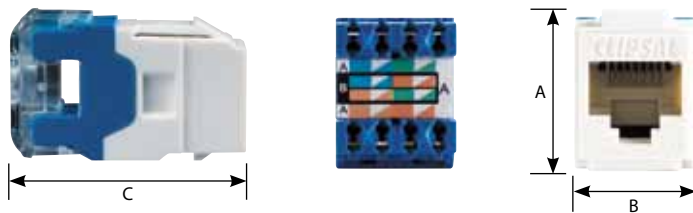

RJ45SMA6,WE

The Clipsal range of products is the next generation of data communication solutions. These modular jacks are colour coded for both 568A and 568B standards. They are designed to be terminated using a 110 tool (Clipsal 110 tool recommended, TRJ45PDT). Clear wire retaining caps are supplied and can be used to provide additional cable strain relief.

DIMENSIONS

Product	A (height)	B (width)	C (depth)
3RJ45SMA6	23mm	15mm	36mm

COLOUR AVAILABILITY



ELECTRICAL CHARACTERISTICS

Dielectric Strength	1,000V RMS at 60Hz for 1 minute
Current Rating	1.5A maximum
Insulation Resistance	200MΩ minimum
Contact Resistance	1MΩ per contact
Temperature Range	-40° C to +70° C
Transmission Performance	ISO/IEC 11801 Class E AS/NZS 3080:2003 Class E

MECHANICAL CHARACTERISTICS

Modular Connector	
RJ45 8-Pin Connector	FCC part 68, subpart F and IEC 60603-7 compliant
Durability	750 insertion cycles minimum
Material	Phosphor bronze with 50 micro-inches of gold over 100 micro-inches nickel plating
IDC Connector	
IDC Connector	Suitable insulation of 22 to 24 AWG (0.64 to 0.41mm)
Insulation Diameter (Wire)	0.70 - 1.60mm
Connector Material	Phosphor bronze with nickel plating
IDC Body and Cover Material	Fire-retardant UL 94V-0, plastic

PRODUCT FEATURES

- Fully compliant to AS/NZS 3080:2003, ISO/IEC 11801 2002 and ANSI/TIA/EIA-568-B Series Connecting Hardware Standards.
- Backward compatible with Category 5e products.
- UL 94V-0 rated.
- Accepts solid 22-24 AWG diameter conductors.
- Universal colour coding for 568A and 568B standards.

CUSTOMER BENEFITS

- Various colours for easier circuit identification.
- Can be used in multi-user telecommunication outlet applications (MUTO).
- Clear IDC caps allow for termination verification and assist in cable retention.

CATALOGUE NUMBER DESCRIPTION

RJ45SMA6 (XX) Category 6 UTP RJ45 Connector, Keystone

(XX) for Colour: (WE) White, (BK) Black, Blue (BU), Yellow (YL), Red (RD), Green (GR) and Soft Grey (SG)

Clipsal Category 6 UTP Jacks Shuttered Modular - Suits Clipsal Wall Plates



30RJ45SMA6SH,WE

The Clipsal range of products is the next generation of data communication solutions. These modular jacks are colour coded for both 568A and 568B standards. They are designed to be terminated using a 110 tool (Clipsal 110 tool recommended, TRJ45PDT). Clear wire retaining caps are supplied and can be used to provide additional cable strain relief.

DIMENSIONS

Product	A (height)	B (width)	C (depth)
30RJ45SMA6SH	23mm	23mm	35mm

COLOUR AVAILABILITY



ELECTRICAL CHARACTERISTICS

Dielectric Strength	1,000V RMS at 60Hz for 1 minute
Current Rating	1.5A maximum
Insulation Resistance	200MΩ minimum
Contact Resistance	1MΩ per contact
Temperature Range	-40° C to +70° C
Transmission Performance	ISO/IEC 11801 Class E AS/NZS 3080:2003 Class E

MECHANICAL CHARACTERISTICS

Modular Connector	
RJ45 8-Pin Connector	FCC part 68, subpart F and IEC 60603-7 compliant
Durability	750 insertion cycles minimum
Material	Phosphor bronze with 50 micro-inches of gold over 100 micro-inches nickel plating
IDC Connector	
IDC Connector	Suitable insulation of 22 to 24 AWG (0.64 to 0.41mm)
Insulation Diameter (Wire)	0.70 - 1.60mm
Durability	10 insertions of any combination of wire gauge (two wires per slot)
Connector Material	Phosphor bronze with nickel plating
IDC Body and Cover Material	Fire-retardant UL 94V-0, plastic

PRODUCT FEATURES

- Fully compliant to AS/NZS 3080:2003, ISO/IEC 11801 2002 and ANSI/TIA/EIA-568-B Series Connecting Hardware Standards.
- Backward compatible with Category 5e products.
- Flexible locking tabs.
- UL 94V-0 rated.
- Accepts solid 22-24 AWG diameter conductors.
- Universal colour coding for 568A and 568B standards.
- IP22 rated.

CUSTOMER BENEFITS

- Various colours for easier circuit identification.
- Can be used in multi-user telecommunication outlet applications (MUTO).
- Flexible locking tabs for easy removal from wall plates.
- Clear IDC caps allow for termination verification and assist in cable retention.



IP22 Rated

- Prevents dust ingress.
- Protects against insect infestation.
- Deters foreign object insertion.

CATALOGUE NUMBER DESCRIPTION

30RJ45SMA6SH (XX) Category 6 UTP RJ45 Connector, Shuttered, Suits Clipsal Wall Plates

(XX) for Colour: White (WE), Black (BK), Blue (BU), Yellow (YL), Red (RD), Green (GR), Soft Grey (SG), Cream (CR) and Battleship Grey (GB)

Clipsal Category 6 UTP Jacks Shuttered Keystone



RJ45SMA6SH,WE

The Clipsal range of products is the next generation of data communication solutions. These modular jacks are colour coded for both 568A and 568B standards. They are designed to be terminated using a 110 tool (Clipsal 110 tool recommended, TRJ45PDT). Clear wire retaining caps are supplied and can be used to provide additional cable strain relief.

DIMENSIONS

Product	A (height)	B (width)	C (depth)
RJ45SMA6SH	23mm	15mm	36mm

COLOUR AVAILABILITY



ELECTRICAL CHARACTERISTICS

Dielectric Strength	1,000V RMS at 60Hz for 1 minute
Current Rating	1.5A maximum
Insulation Resistance	200MΩ minimum
Contact Resistance	1MΩ per contact
Temperature Range	-40° C to +70° C
Transmission Performance	ISO/IEC 11801 Class E AS/NZS 3080:2003 Class E

MECHANICAL CHARACTERISTICS

Modular Connector	
RJ45 8-Pin Connector	FCC part 68, subpart F and IEC 60603-7 compliant
Durability	750 insertion cycles minimum
Material	Phosphor bronze with 50 micro-inches of gold over 100 micro-inches nickel plating
IDC Connector	
IDC Connector	Suitable insulation of 22 to 24 AWG (0.64 to 0.41mm)
Insulation Diameter (Wire)	0.70 - 1.60mm
Connector Material	Phosphor bronze with nickel plating
IDC Body and Cover Material	Fire-retardant UL 94V-0, plastic

PRODUCT FEATURES

- Fully compliant to AS/NZS 3080:2003, ISO/IEC 118012002 and ANSI/TIA/EIA-568-B Series Connecting Hardware Standards.
- Clipsal's patented flush-faced, zero footprint, shutter mechanism.
- Backward compatible with Category 5e products.
- UL 94V-0 rated.
- Accepts solid 22-24 AWG diameter conductors.
- Universal colour coding for 568A and 568B standards.
- IP22 rated.

CUSTOMER BENEFITS

- Shutter mechanism is easy to operate, simply insert the plug lead into the jack.
- Protection from dust ingress, insect infestation and the insertion of foreign objects.
- Various colours for easier circuit identification.
- For use in multi-user telecommunication outlet applications (MUTO).
- Clear IDC caps allow for termination verification and assist in cable retention.



IP22 Rated

- Prevents dust ingress.
- Protects against insect infestation.
- Deters foreign object insertion.

CATALOGUE NUMBER	DESCRIPTION
RJ45SMA6SH (XX)	Category 6 UTP RJ45 Connector, Shuttered, Keystone
(XX) for Colour: White (WE), Black (BK), Blue (BU), Yellow (YL), Red (RD), Green (GR) and Soft Grey (SG)	

Clipsal Category 6 UTP Patch Panel 24 Port

The Clipsal patch panel features individual Category 6 jacks that are colour coded for both 568A and 568B standards and must be terminated using a 110 tool (Clipsal 110 tool recommended, TRJ45PDT).

Each patch panel is supplied with rear cable management tray, velcro cable ties, cage nuts and screws.



RJ6/24PP

ELECTRICAL CHARACTERISTICS

Dielectric Strength	1,000V RMS at 60Hz for 1 minute
Current Rating	1.5A maximum
Insulation Resistance	200MΩ minimum
Contact Resistance	1MΩ per contact
Temperature Range	-40° C to +70° C
Transmission Performance	ISO/IEC 11801 Class E AS/NZS 3080:2003 Class E

MECHANICAL CHARACTERISTICS

Modular Connector	
RJ45 8-Pin Connector	FCC part 68, subpart F and IEC 60603-7 compliant
Durability	1000 mating cycles
Material	Phosphor bronze with 50 micro-inches of gold over 100 micro-inches nickel plating
IDC Connector	
IDC Connector	Suitable insulation of 22 to 24 AWG (0.64 to 0.41mm)
Insulation Diameter (Wire)	0.70 - 1.60mm
Durability	10 insertions of any combination of wire gauge (two wires per slot)
Connector Material	Phosphor bronze with nickel plating
IDC Body and Cover Material	Fire-retardant, UL 94V-0, plastic

PRODUCT FEATURES

- Fully compliant to AS/NZS 3080:2003, ISO/IEC 11801 2002 and ANSI/TIA/EIA-568-B Series Connecting Hardware Standards.
- Powder coated metal framework.
- Universal colour coding for 568A and 568B standards.
- Removable rear cable management tray.
- Compatible with standard 19" equipment frames.
- Individual removable jack.
- Complete with all mounting and cable fixing hardware.

CUSTOMER BENEFITS

- Category 6 performance.
- Rear cable management tray is supplied loose, allowing the installer to fit after termination.
- The front labelling system provides a clear and efficient means of identifying circuits.
- Powder coated metal frame is robust and protects the patch panel from corrosion and scratching.

CATALOGUE NUMBER	DESCRIPTION
RJ6A1/24PP	Category 6 UTP, 24 Port Patch Panel
RJ5/6CTWLS	Patch Panel Window Label Stickers, Suits Category 5e and 6 (10 sheets, 5 numbered and 5 blank)
RJ45SMA6,BK	Category 6 Keystone Modular Jack (replacement jack suitable for patch panel)

Clipsal Category 6 UTP Patch Panels 24 Port Shuttered

The Clipsal shuttered patch panel features individual shuttered Category 6 jacks that are colour coded for both 568A and 568B standards and must be terminated using a 110 tool (Clipsal 110 tool recommended, TRJ45PDT).

Each patch panel is supplied with rear cable management tray, velcro cable ties, cage nuts and screws.



RJ6/24PPSH

ELECTRICAL CHARACTERISTICS

Dielectric Strength	1,000V RMS at 60Hz for 1 minute
Current Rating	1.5A maximum
Insulation Resistance	200MΩ minimum
Contact Resistance	1MΩ per contact
Temperature Range	-40° C to +70° C
Transmission Performance	ISO/IEC 11801 Class E AS/NZS 3080:2003 Class E

MECHANICAL CHARACTERISTICS

Modular Connector	
RJ45 8-Pin Connector	FCC part 68, Subpart F and IEC 60603-7 compliant
Durability	1000 mating cycles
Material	Phosphor bronze with 50 micro-inches of gold over 100 micro-inches nickel plating
IDC Connector	
IDC Connector	Suitable insulation of 22 to 24 AWG (0.64 to 0.41mm)
Insulation Diameter (Wire)	0.70 - 1.60mm
Durability	10 insertions of any combination of wire gauge (two wires per slot)
Connector Material	Phosphor bronze with nickel plating
IDC Body and Cover Material	Fire-retardant, UL 94V-0, plastic

PRODUCT FEATURES

- Fully compliant to AS/NZS 3080:2003, ISO/IEC 11801 Edition 2 2002 and ANSI/TIA/EIA-568-B Series Connecting Hardware Standards.
- Shuttered outlets/ports.
- Powder coated metal framework.
- Universal colour coding for 568A and 568B standards.
- Removable rear cable management tray.
- Compatible with standard 19" equipment frames.
- Complete with all mounting and cable fixing hardware.

CUSTOMER BENEFITS

- Outlet shutters protect the contact pins from dust/insect ingress and the insertion of foreign objects.
- Category 6 performance.
- Rear cable management tray is supplied loose, allowing the installer to fit after termination.
- The front labelling system provides a clear and efficient means of identifying circuits.
- Powder coated metal frame is robust and protects the patch panel from corrosion and scratching.



IP22 Rated

- Prevents dust ingress.
- Protects against insect infestation.
- Deters foreign object insertion.

CATALOGUE NUMBER	DESCRIPTION
RJ6/24PPSH	Category 6 UTP, 24 Port Shuttered Patch Panel
RJ5/6CTWLS	Patch Panel Window Label Stickers, Suits Category 5e and 6, (10 sheets, 5 numbered and 5 blank)
RJ45SMA6SH,BK	Category 6 UTP Shuttered Keystone Modular Jack (replacement jack suitable for patch panel)

Patch Panel Labels

To complement the range of Clipsal patch panels, Clipsal Datacomms have introduced window label stickers. This value-added product has been designed specifically for the following patch panels in the portfolio:

- RJ6/24PP
- RJ6/24PPSH.

The Clipsal patch panel window label stickers provide a professional finishing touch to any structured cabling system.

Each pack contains 10 A4 label sheets; five with small numbers on the left hand side (1 – 144) and five sheets with blank labels. There are 18 labels per sheet and each window label accommodates one block of eight data outlets. The stickers are finished in silver to match the front fascia of the patch panels. Most inkjet and laser printers will print on these labels.

Customers can download the printing software from clipsal.com, simply type in <http://www.clipsal.com/label> to take you to the product page and link to the software. The instructions found on the web page provide handy hints in formatting, printing and adhering the identification stickers.



RJ5/6CTWLS

A01	A02	A03	A04	A05	A06	A07	A08
A09	A10	A11	A12	A13	A14	A15	A16
A17	A18	A19	A20	A21	A22	A23	A24
B01	B02	B03	B04	B05	B06	B07	B08
B09	B10	B11	B12	B13	B14	B15	B16
B17	B18	B19	B20	B21	B22	B23	B24
C01	C02	C03	C04	C05	C06	C07	C08
C09	C10	C11	C12	C13	C14	C15	C16
C17	C18	C19	C20	C21	C22	C23	C24
D01	D02	D03	D04	D05	D06	D07	D08
D09	D10	D11	D12	D13	D14	D15	D16
D17	D18	D19	D20	D21	D22	D23	D24
E01	E02	E03	E04	E05	E06	E07	E08



CATALOGUE NUMBER DESCRIPTION

RJ5/6CTWLS Patch Panel Window Label Stickers, Suits Clipsal Category 5e and 6 (10 sheets, 5 numbered and 5 blank)

Clipsal Category 6 UTP Cable

The Clipsal 4 Pair Category 6 cable is a superior product delivering excellent network performance when used in conjunction with other Clipsal Category 6 products.

The cable consists of 4 pairs of solid insulated copper 23 AWG (0.57mm) and is UL listed with a CM fire rating. It is designed for use in horizontal cabling situations and supplied in 305m (1,000ft) easy pull-out boxes.

The Category 6 cable provides a significant margin (10 dB) above the minimum Category 6 near end crosstalk (NEXT) requirement of TIA/EIA 568-B.2-1, ISO/IEC 11801 and AS/NZS 30801:2003 Class E.



2D4P6IPV3B, BU

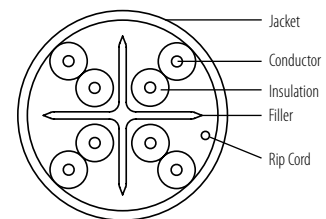

PHYSICAL SPECIFICATIONS

Rated Temperature (°C)	75
Product Standard Certification	UL file E215065
Flammability Test	CM
Application	Horizontal wiring in LAN
Reference Standard	UL Subject 444, EIA/TIA568 & ISO/IEC 11801, IEC61156-5
Comply to RoHS	Yes

CONSTRUCTION

Conductor	Solid bare copper (annealed)
Gauge (AWG)	23
Conductor Diameter Nom. (mm)	0.57
Insulation	HDPE
Average Thickness (mm)	0.22
Minimum Point Thickness (mm)	0.18
Insulation Diameter (±0.10mm)	± 0.10
Twisting Lay Length (mm)	P1:10±0.5, P2:17±0.5, P3:11±0.5, P4:13±0.5
Cabling Lay Length (mm)	135±5
Filler	PE
Jacket	PVC
Average Thickness (±0.05mm)	0.58
Minimum Point Thickness (mm)	0.46
Outer Diameter (±0.2mm)	6.10
Rip Cord	YES

MECHANICAL CHARACTERISTICS

Test Object	Jacket
Test Material	PVC
Before Tensile Strength (Mpa)	≥13.8
Aging Elongation (%)	≥100
Aging Condition (°C x hrs)	100 °C x 240 hrs
After Tensile Strength (Mpa)	≥85% of original
Aging Elongation (%)	≥50% of original
Cold Bend (-20 ± 2 °C x 4hrs)	No crack
Bend Radius (mm)	50 (25 after install)

ELECTRICAL CHARACTERISTICS

Frequency (MHz)	Return Loss (dB)	Attenuation (dB/100m)	ACR (dB)	Delay (ns/100m)
1	20.0	2.0	72.3	570.0
4	23.0	3.8	61.5	/
8	24.50	5.3	55.5	/
10	25.0	6.0	53.3	545.0
16	25.0	7.6	48.6	/
20	25.0	8.5	46.3	/
25	24.3	9.5	43.8	/
31.25	23.6	10.7	41.2	/
62.5	21.5	15.4	32.0	/
100	20.1	19.8	24.5	538.0
200	18.0	29.0	10.8	/
250	17.3	32.8	5.5	536.0

Frequency (MHz)	NEXT (dB)	PSNEXT (dB)	ELFEXT (dB/100m)	PSELFEXT (dB/100m)
1	74.3	72.3	67.8	64.8
4	65.3	63.3	55.8	52.8
8	60.8	58.8	49.7	46.7
10	59.3	57.3	47.8	44.8
16	56.2	54.2	43.7	40.7
20	54.8	52.8	41.8	38.8
25	53.3	51.3	39.8	36.8
31.25	51.9	49.9	37.9	34.9
62.5	47.4	45.4	31.9	28.9
100	44.3	42.3	27.8	24.8
200	39.8	37.8	21.8	18.8
250	38.3	36.3	19.8	16.8

1.0-100.0MHz Input Impedance (Ohms)	100 ± 15
100-250MHz Input Impedance (Ohms)	100 ± 22
1.0-250.0MHz Delay Skew (ns/100m)	≤45
Pair-to-ground Capacitance Unbalance (pF/100m)	≤330
Maximum Conductor DC Resistance 20 °C (Ohms/km)	73.2
Resistance Unbalance (%)	≤5
Nominal Velocity of Propagation (NVP%)	69

CATALOGUE NUMBER	DESCRIPTION
2D4P6IPV3B (XX)	Category 6 UTP, 4 Pair Cable, 23AWG, 305m
(XX) for Colour: Blue (BU), Yellow (YL), Red (RD), Green (GR) and Grey (GY)	

Clipsal Cable Management Panel Deep

The Clipsal cable management panel is a one rack unit (1RU) item designed for use in 19" rack environments, managing patch cords that are connected between patch panels and/or active switches. The product is recommended for mounting between every second row of patch panels/active switches.

The unique clips provide a quick and simple means of installing the panel in the rack or cabinet. The rings have been designed to facilitate easy insertion and removal of the patch leads; necessary in dynamic environments where moves and changes are required.

DIMENSIONS

Product	A (height)	B (width)	C (depth)
RJ1UCMPC	44mm	482mm	100mm

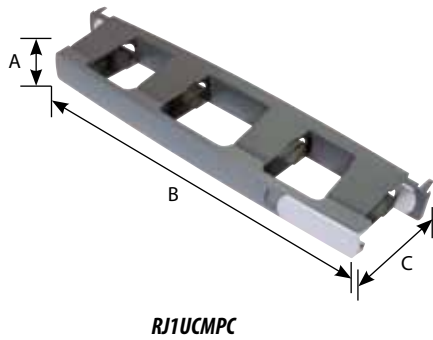

RJ1UCMPC



Rack clips for easy mounting



Reinforced cable rings

PRODUCT FEATURES

- Clip-on cover (patented).
- Rack mount clips eliminate the need for cage nuts and screws.
- Cavities behind each ring provide additional space for cable slack.
- Additional depth on cable rings ensure compliance with minimum bend radius requirements.

CUSTOMER BENEFITS

- Quick product installation using rack mount clips.

CATALOGUE NUMBER	DESCRIPTION
RJ1UCMPC	1RU Cable Management Panel, Deep

Clipsal Side Rings

The side rings are typically used in frames or cabinets to provide vertical patch cord management. These rings have several features that make them stand out. The “ring and lock” design utilises proven plastic hinge technology to guide patch cords. These rings have unique teeth locks that are easy to open and snap back to lock tight again, should you need to open the rings.

The rings can be mounted with patch panels or directly onto the vertical panel mounts (VPM) of the equipment frame.

MECHANICAL CHARACTERISTICS

Test Object	Jacket
Ring Material	Polypropylene, Graphite Grey

DIMENSIONS

Product	A (height)	B (width)	C (depth)
RJ1HUSSR	42mm	43mm	65mm
RJ1HUDSR	42mm	43mm	130mm

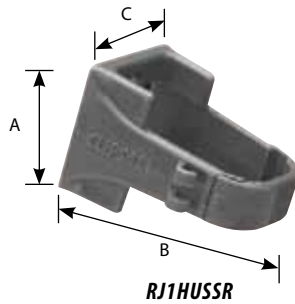
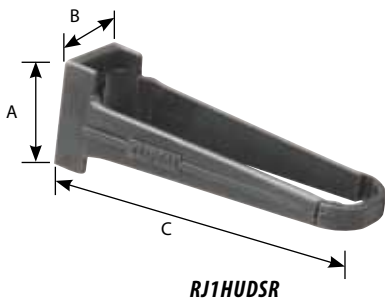

RJ1HUDSR



RJ1HUSSR

PRODUCT FEATURES

- Graphite Grey.
- Teeth locks that provide easy access and security for patch cords.
- Available in deep and shallow versions.

CUSTOMER BENEFITS

- The “ring and lock” design not only makes the loading and unloading of patch cords or cables easier, it also secures them in place. This keeps the cabinet neat and uncluttered. Circuit identification and administration for the customer is also far more efficient.
- The two ring depths enable the customer to manage the cabinet or rack better depending on the amount of patch cords being used.

CATALOGUE NUMBER	DESCRIPTION
RJ1HUSSR	1RU Shallow Side Ring
RJ1HUDSR	1RU Deep Side Ring

MUTOS

MULTI USER TELECOMMUNICATIONS OUTLETS (MUTO)

Clipsal provides a range of MUTO options, which are ideal in situations where a number of terminals are required in the one area.

Floor outlet housings can also be used in desktop applications where up to 12 services are required, and fit all standard Clipsal face plates.

All Clipsal 2000 Series Wall Plates will fit into the housing and surrounds of the MUTO's.



224/1



2000/3



2000H2



**Loaded 224/1
Floor Outlet**



Loaded Faceplate

CATALOGUE NUMBER	DESCRIPTION
224/1	Floor Outlet Housing for 2 Standard Plates, Can be used on Desktops
224/2	Floor Outlet Housing for 4 Standard Plates, Can be used on Desktops
2000/2	2 Gang Flush Surround, Curved Sides, Suits all 2000 Series Grids
2000/3	3 Gang Flush Surround, Curved Sides, Suits all 2000 Series Grids
2000/4	4 Gang Flush Surround, Curved Sides, Suits all 2000 Series Grids
2000H2	Horizontal 2 Gang Flush Surround, Curved Sides, Suits all 2000 Series Grids
2000H4	Horizontal 4 Gang Flush Surround, Curved Sides, Suits all 2000 Series Grids

Surface Mount Blocks

The Clipsal surface mount blocks are suitable for desk or wall mounting. The port sizes range from one through to six ports, and can be accommodated side-by-side to give greater port counts, if necessary. The blocks come with screws and double-sided tape to provide an alternative mounting option.

TECHNICAL SPECIFICATIONS

	Height	Width	Depth
1 Port	25.1mm	38.4mm	58mm
2 Port	25.1mm	62mm	58mm
3 Port	25.2mm	114.3mm	70mm
6 Port	35mm	170mm	110mm

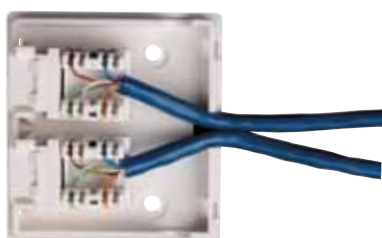

SMRJ45A6/1,WE



SMRJ45A6/2,WE



SMRJ45A6/4,WE



SMRJ45A6/6,WE

PRODUCT FEATURES

- Surface mounted on either wall or desk.
- Accommodates modular products.
- Port labelling area provided.
- Category 6 connectors included.

CATALOGUE NUMBER	DESCRIPTION
SMRJ45A6/1,WE	Surface Mount Block, 1 Port, Category 6 RJ45, White (WE)
SMRJ45A6/2,WE	Surface Mount Block, 2 Port, Category 6 RJ45, White (WE)
SMRJ45A6/4,WE	Surface Mount Block, 4 Port, Category 6 RJ45, White (WE)
SMRJ45A6/6,WE	Surface Mount Block, 6 Port, Category 6 RJ45, White (WE)

CATEGORY 6 PATCH BY EXCEPTION (PBE) SOLUTION

Modules
Frames and Covers
Labelling and Accessories
Patch Cords
Cable Management

Category 6 Patch by Exception (PBE)

Patch by Exception is a jumpered block cabling solution with the flexibility of overriding the jumpers with the simple use of a patch cord. This effectively provides the simplicity of an RJ solution without the need for patch management, thereby eliminating messy wiring. Clipsal 3104 Series Patch by Exception modules guarantee excellent high output transmission performance. The short contacts enable considerable reduction in crosstalk and attenuation, providing superior headroom required in supporting existing and future technologies.

Patch by exception is suited for a UTP solution.

PATCH BY EXCEPTION PRODUCTS INCLUDE:

- Modules
- Frames and Covers
- Patch and Test Cords
- Accessories.

FEATURES OF PATCH BY EXCEPTION:

- High density solution
- Colour coded for easy identification of services
- Jumpering and patching facility
- Neat and clean solution without untidy patch cords
- Disconnect facility for protection of services
- Overvoltage protection available
- Single pair administration
- Controlled access to services
- Test access through disconnect facility
- Compatible with multistrand or solidcore cables
- Simpler record management.

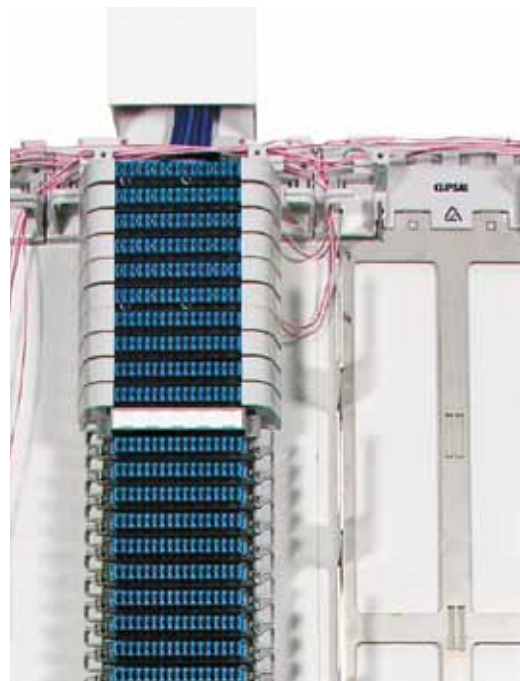

Category 6 PBE Modules

Patch by Exception Modules are a Category 6 compliant, high-performance, 8 pair, punchdown product for voice and data applications.

Constructed from self-extinguishing polycarbonate, the module houses and protects the IDC termination, which is made from phosphor bronze-plated with a tin/lead alloy. The standard termination makes provision for testing, isolation and the fitting of overvoltage protection cartridges in a small compact module.

Different coloured modules can be used to distinguish between services. These services can be as follows:

- Yellow - Active equipment (switches)
- Green - Interfloor cabling (backbone)
- Blue - Horizontal distribution (communication outlets)
- Ivory - Voice services (Category 5e).

ELECTRICAL CHARACTERISTICS

Lead-through Resistance	Less than 20MΩ
Insulation Resistance Under 500V	Greater than 100MΩ
Dielectric Strength	Greater than 4000V
NEXT	5dB
NEXT in a Consolidation Point	3dB
Return Loss (RL)	3.5dB

PHYSICAL CHARACTERISTICS

Insertion Life (min.)	750 cycles
Storage Temperature	-40°C to +70°C
Operating Temperature	-10°C to +60°C
Humidity (max.)	93% (non condensing)
Plastic Components	Polycarbonate, UL94V-0
Contact Material	Tinned (more than 5µm) coated bronze

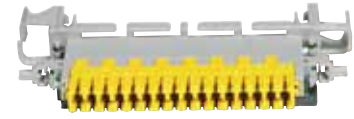

3104PBE8P6,YL

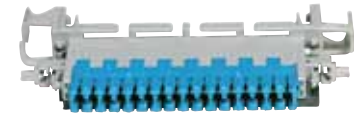

3104PBE8P6,BU

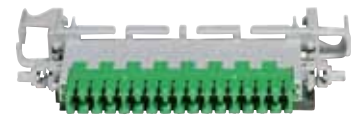

3104PBE8P6,GR



3104PBE8,IV (Category 5e)

PRODUCT FEATURES

- Fully compliant to AS/NZS 3080:2003, ISO/IEC 11801 Edition 2 2002 and ANSI/TIA/EIA-568-B Series Connecting Hardware Standards, Class D and E.
- Embedded IDC contacts.
- Isolated individual pairs via cross-talk barrier technology.
- Channel wire guide ensures maintenance of conductor twist rates.
- Integrated into the high density product portfolio.
- Accepts conductor sizes 22-24 AWG (0.4mm-0.8mm) solid or strand with maximum overall diameter 22-26 AWG.

CUSTOMER BENEFITS

- Enhanced protection and longer life cycle.
- Reduced cross talk, attenuation and improved NEXT.

CATALOGUE NUMBER	DESCRIPTION
3104PBE8P6,YL	Category 6, 8 Pair Module, Yellow
3104PBE8P6,BU	Category 6, 8 Pair Module, Blue
3104PBE8P6,GR	Category 6, 8 Pair Module, Green
3104PBE8,IV	Category 5e, 8 Pair Module, Ivory

Category 6 PBE Frames and Covers Wall and Rack Mount

Patch by Exception Frames utilise the same interlocking composition and dimensions as the 100 Pair and 250 Pair voice frames. This provides installers and end users with a seamless solution for their voice and data infrastructure.

Available in 13 way (104 Pair) and 35 way (280 Pair) configurations, the frames accommodate the PBE modules and offer cable management for incoming feeds.

DIMENSIONS

Product	A (width)	B (height)	C (depth)
3104PBE13F	195mm	360mm	-
3104PBE35F	195mm	710mm	-
3100C100MDF	202mm	357mm	123mm
3100C250MDF	203mm	722mm	123mm

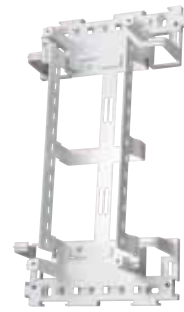

3104PBE13F

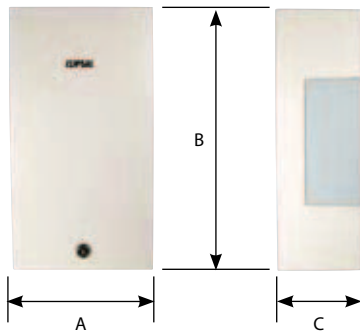

3100C100MDF

PRODUCT FEATURES

- Accepts all PBE modules.
- Links with other frames in the Voice portfolio (3104PBExxF, wallmount frames).
- Cable management for incoming cables.
- Metal covers for mechanical protection and security.

CUSTOMER BENEFITS

- Uniformity in voice and data infrastructure (3104PBExxF).
- High density, cost-effective solution.
- Consolidated communications point.
- Temporary changes can be done by simple patching.

CATALOGUE NUMBER	DESCRIPTION
3104PBE13F	13 Way (104 Pairs) Wall Mount Frame
3104PBE35F	35 Way (280 Pairs) Wall Mount Frame
3100C100MDF	Cover for 13 Way Wall Mount Frame (suitable for 3104PBE13F)
3100C250MDF	Cover for 35 Way Wall Mount Frame (suitable for 3104PBE35F)

Category 6 PBE Labelling and Accessories

A comprehensive range of label holders is available to complement the PBE modules and frames. These products allow installers and end users to easily identify incoming cables and circuit destinations.

The 3100RJA5V punchdown tool must be used for installation of the Clipsal Patch by Exception Solution.

A range of overvoltage protection products are available.

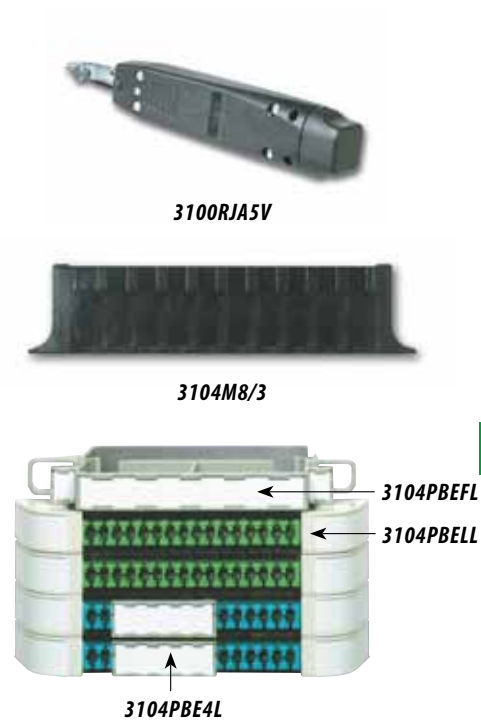

CATALOGUE NUMBER	DESCRIPTION
3100RJA5V	IDC Termination Tool (suits PBE 3104 modules)
3104M8/3	Overvoltage Arrester Magazine 8 Pair, 3 Pole, for use with 3104A250/1
3104A250/1	250V Gas Arrester, 3 Pole (suits 3104M8/3)
3104PBEFL	Frame Label Holder
3104PBELL	Lateral Label (set of 10)
3104PBE4L	4 Pair Label for Identification of 4 Pair Services
3104PBEMC	Marking Caps, Available in BU (Blue), GR (Green) and YL (Yellow)

Category 6 PBE Patch Cords

The Clipsal 3104 PBE Series patch leads allow for isolation of pairs for voice or data transmission, and also isolation of incoming and outgoing pairs for test purposes. Patch cords are available in IDC to IDC or IDC to RJ45 configurations, with lengths of 1m to 5m.

All 4 pair patch cords comply with all transmission standards for Category 6.



1 Pair



2 Pair

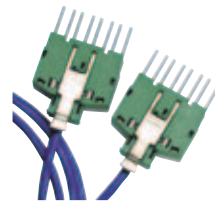

4 Pair

CATALOGUE NUMBER	DESCRIPTION
3104PL1/2	IDC - IDC 1 Pair Patch Cord, 2m
3104PL1/3	IDC - IDC 1 Pair Patch Cord, 3m
3104PL1/5	IDC - IDC 1 Pair Patch Cord, 5m
3104PL2/3	IDC - IDC 2 Pair Patch Cord, 3m
3104PL2/5	IDC - IDC 2 Pair Patch Cord, 5m
3104PL4/1	IDC - IDC 4 Pair Patch Cord, 1m
3104PL4/3	IDC - IDC 4 Pair Patch Cord, 3m
3104PL4/4	IDC - IDC 4 Pair Patch Cord, 4m
3104PL2RJ1	IDC - RJ45 2 Pair Patch Cord, RJ45, 1m
3104PL2RJ2	IDC - RJ45 2 Pair Patch Cord, RJ45, 2m
3104PL2RJ4	IDC - RJ45 2 Pair Patch Cord, RJ45, 4m
3104PL4RJ1	IDC - RJ45 4 Pair Patch Cord, RJ45, 1m
3104PL4RJ3	IDC - RJ45 4 Pair Patch Cord, RJ45, 3m
3104PL4RJ5	IDC - RJ45 4 Pair Patch Cord, RJ45, 5m

Category 6 PBE Cable Management

The new cable management frames provide a simplified means of controlling patch cables between adjoining frames.

DIMENSIONS

Product	A (width)	B (height)	C (depth)
3100CMV100F	202mm	375mm	123mm
3100CMV250F	203mm	722mm	123mm
3100CMH	130mm	182mm	130mm



3100CMV250F

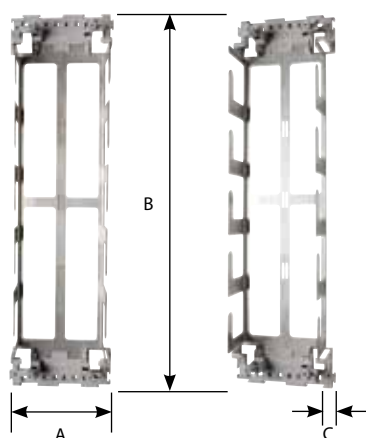

3100CMV250F



3100CMH

PRODUCT FEATURES

- Reduces the occurrence of tangled and messy patching.
- Allows easy routing of patch cords between frames.
- Easily concealed and secured using metal covers.
- Can be interlocked with voice and PBE frames.

CATALOGUE NUMBER	DESCRIPTION
3100CMV100F	Cable Management Frame - Vertical, Suits 100 Pair Voice, 104 Pair PBE and 200 Pair GigaPro Frames
3100CMV250F	Cable Management Frame - Vertical, Suits 250 Pair Voice, 280 Pair PBE and 500 Pair GigaPro Frames
3100CMH	Cable Management Frame - Horizontal

**CATEGORY 6A UTP RJ45
SOLUTION**

Patch Cord Low Smoke Zero Halogen (LSZH)
Modular Jacks
Keystone Jacks
Shuttered Modular Jacks
Shuttered Keystone Jacks
Patch Panel
Cable
Cable Management
Side Rings



Clipsal Category 6A UTP RJ45 Solution

The Clipsal Category 6A UTP system is designed to support 10G BaseT applications, and offers a great solution for an installation requiring high speed and high bandwidth. This solution includes cable, patch panels, patch cables and modular jacks, as well as faceplates and cable management, and offers excellent headroom.

The Clipsal Category 6A UTP patched solution overcomes alien cross talk (AXT) concerns through the use of shielded patch leads. This passive shielding helps prevent AXT at the patch panel.

This system is designed to meet AXT standards when installed in high-density active equipment applications. The product is independently verified, and certificates are available on request. The Clipsal Lifetime Warranty is available upon application.

Clipsal Australia R&D department have worked closely with Schneider Electric R&D department to provide the connector and patch panel we see today. Along with the performance parameters that were needed to be met, we have taken all the feedback from the industry to provide a panel that is installer and end-user friendly.

Clipsal Category 6A Patch Cord Low Smoke Zero Halogen (LSZH)

The Clipsal Category 6A Patch Cord is a superior product delivering the best network performance when used in conjunction with other Clipsal Category 6A products.

The patch cord is constructed of high grade cable and quality RJ45 plugs, and is designed to operate up to 500MHz. This enables it to operate successfully in a Category 6A environment.

The Clipsal Category 6A UTP patched solution uses a FTP patch cord to assist in mitigating alien cross talk (AXT) concerns.

The LSZH sheath is composed of thermoplastic and thermoset compounds that emit limited smoke and zero halogens (poisonous gases), when exposed to high sources of heat or fire, and are PVC free.



RJ6A8A10LPL, BU

MECHANICAL CHARACTERISTICS

Cable	
Gauge	26 AWG
Pair Count	4 Pair individually colour coded with filler and LSZH jacket
Sequence	Wiring sequence T568A
Durability	750 mating cycles
RJ45 Plug	FCC Part68 Subpart F
Plug Boot	LSZH
Contact Material	Phosphor bronze with 50 micro-inches gold over 100 micro-inches nickel

ELECTRICAL CHARACTERISTICS

Current Rating	2.0 A maximum
Insulation	500MΩ minimum
Contact Resistance	20MΩ maximum

LINE DRAWING

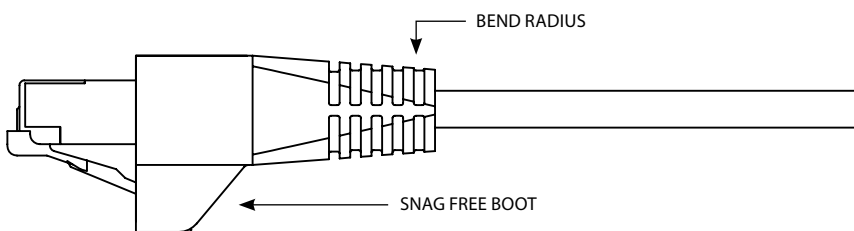

PRODUCT FEATURES

- Fully compliant to AS/NZS 3080, ISO/IEC 11801 and ANSI/TIA/EIA-568-C Series Channel and Link Standards.
- UL LSZH fire rated jacketing.
- PE insulation on conductors.
- Designed to mitigate AXT.

CUSTOMER BENEFITS

- Performs to Category 6A International Standards.
- Comes in various lengths to assist with better cable management.
- Backward compatible with Category 5 and 6 products.
- Complies to LSZH requirements.

CATALOGUE NUMBER	DESCRIPTION
RJ6AF8A10LPL,(XX)	Category 6A FTP Patch Cord LSZH 568A, 1.0m (suitable for use in UTP installations)
RJ6AF8A20LPL,(XX)	Category 6A FTP Patch Cord LSZH 568A, 2.0m (suitable for use in UTP installations)
RJ6AF8A30LPL,(XX)	Category 6A FTP Patch Cord LSZH 568A, 3.0m (suitable for use in UTP installations)
RJ6AF8A50LPL,(XX)	Category 6A FTP Patch Cord LSZH 568A, 5.0m (suitable for use in UTP installations)

(XX) for Colour: Blue (BU)

Clipsal Category 6A UTP Jacks Modular - Suits Clipsal Wall Plates



30RJ45SMA6A,WE

The Clipsal range of products are the next generation of data communications solutions. These modular jacks are colour coded for both 568A and 568B standards. Clear wire retaining caps are supplied and should be used to provide additional cable strain relief.

This modular connector is designed to be terminated using a 110 tool (Clipsal 110 tool recommended, TRJ45PDT).

DIMENSIONS

Product	A (height)	B (width)	C (depth)
30RJ45SMA6A	23mm	23mm	35mm

COLOUR AVAILABILITY



ELECTRICAL CHARACTERISTICS

Dielectric Strength	1,000V RMS at 60Hz for 1 minute
Current Rating	1.5A maximum
Insulation Resistance	200MΩ minimum
Contact Resistance	1MΩ per contact
Temperature Range	-40° C to +70° C
Transmission Performance	ISO/IEC 11801 Class EA AS/NZS 3080:2003 Class EA

MECHANICAL CHARACTERISTICS

Modular Connector	
RJ45 8-Pin Connector	FCC part 68, subpart F and IEC-60603-7 compliant
Durability	750 insertion cycles minimum
Material	Phosphor bronze with 50 micro-inches of gold over 100 micro-inches nickel plating
Format	30 mechanism non-shuttered
IDC Connector	
IDC Connector	Suitable insulation of 22 to 24 AWG (0.64 to 0.41mm)
Insulation Diameter (Wire)	0.70 - 1.60mm
Connector Material	Phosphor bronze with nickel plating
IDC Body and Cover Material	Fire-retardant UL 94V-0, plastic

PRODUCT FEATURES

- Fully compliant to AS/NZS 3080, ISO/IEC 11801, and ANSI/TIA/EIA-568-C Series.
- Backward compatible with Category 5e and Category 6 products.
- Flexible locking tabs.
- UL 940-0 rated.
- Accepts solid 22 - 24 AWG diameter conductors.
- Copper shielded shutter cap to eliminate alien crosstalk associated with Category 6A.
- Retaining cap supplied for added cable strain relief.

CUSTOMER BENEFITS

- Various colours for easier circuit identification.
- Can be used in Multi-User Telecommunication Outlet applications (MUTO) and Consolidation Points (CP).
- Clear insulation displacement connector caps allow for termination verification and assist in cable retention.

CATALOGUE NUMBER DESCRIPTION

30RJ45SMA6A, (XX) Category 6A UTP RJ45 Connector, Suits Clipsal Wall Plates.

(XX) for Colour: White (WE), Black (BK), Blue (BU), Yellow (YL), Red (RD), Green (GR), Soft Grey (SG), Cream (CR) and Battleship Grey (GB)

Clipsal Category 6A UTP Jacks Keystone

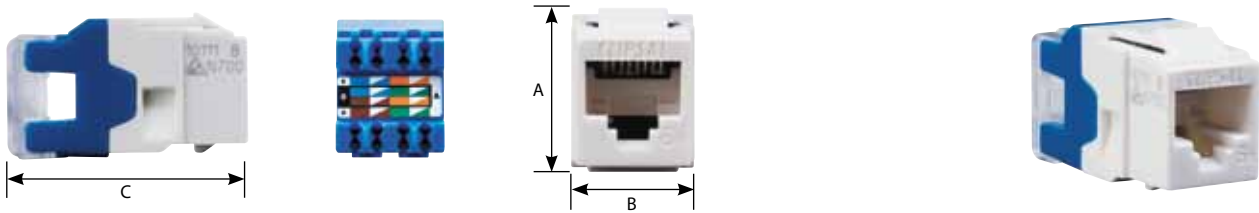

RJ45SMA6A,WE

The Clipsal Category 6A UTP keystone jack is a superior product delivering the best network performance when used in conjunction with other products in this range.

The Clipsal range of products are the next generation of data communications solutions. These UTP modular jacks are colour coded for both 568A and 568B standards.

This keystone connector is designed to be terminated using a 110 tool (Clipsal 110 tool recommended, TRJ45PDT).

DIMENSIONS

Product	A (height)	B (width)	C (depth)
RJ45SMA6A	23mm	15mm	36mm

COLOUR AVAILABILITY



ELECTRICAL CHARACTERISTICS

Dielectric Strength	1,000V RMS at 60Hz for 1 minute
Current Rating	1.5A maximum
Insulation Resistance	200MΩ minimum
Contact Resistance	1MΩ per contact
Temperature Range	-40° C to +70° C
Transmission Performance	Exceeds ISO/IEC 11801 Class EA AS/NZS 3080:2003 Class EA

MECHANICAL CHARACTERISTICS

Modular Connector	
RJ45 8-Pin Connector	FCC part 68, subpart F and IEC-60603-7 compliant
Durability	750 insertion cycles minimum
Material	Phosphor bronze with 50 micro-inches of gold over 100 micro-inches nickel plating
Format	Keystone non-shuttered
IDC Connector	
IDC Connector	Suitable insulation of 22 to 24 AWG (0.64 to 0.41mm)
Insulation Diameter (Wire)	0.70 - 1.60mm
Connector Material	Phosphor bronze with nickel plating
IDC Body and Cover Material	Fire-retardant UL 94V-0, plastic

PRODUCT FEATURES

- Fully compliant to AS/NZS 3080, ISO/IEC 11801, ANSI/TIA/EIA-568-C Series.
- Backward compatible with Category 5e and Category 6.
- UL 94V-0 rated.
- Accepts solid 22 - 24 AWG diameter conductors.

CUSTOMER BENEFITS

- Various colours for easier circuit identification.
- Can be used in Multi-User Telecommunication Outlet applications (MUTO) and Consolidation Points (CP).
- Clear insulation displacement connector caps allow for termination verification and assist in cable retention.
- Suitable for use with the Clipsal Category 6A UTP patch panel RJ6AU/24PP and RJ6AU/24PPS.

CATALOGUE NUMBER DESCRIPTION

RJ45SMA6A, (XX) Category 6A UTP RJ45 Connector, Keystone

(XX) for Colour: White (WE), Black (BK), Blue (BU), Yellow (YL), Red (RD), Green (GR) and Soft Grey (SG)

Clipsal Category 6A UTP Jacks Shuttered Modular - Suits Clipsal Wall Plates



30RJ45SMA6AS,WE

The Clipsal range of products are the next generation of data communications solutions. These shuttered modular jacks are colour coded for both 568A and 568B standards. Clear wire retaining caps are supplied and should be used to provide additional cable strain relief.

This shuttered modular connector is designed to be terminated using a 110 tool (Clipsal 110 tool recommended, TRJ45PDT).

DIMENSIONS

Product	A (height)	B (width)	C (depth)
30RJ45SMA6AS	23mm	23mm	35mm

COLOUR AVAILABILITY



ELECTRICAL CHARACTERISTICS

Dielectric Strength	1,000V RMS at 60Hz for 1 minute
Current Rating	1.5A maximum
Insulation Resistance	200MΩ minimum
Contact Resistance	1MΩ per contact
Temperature Range	-40° C to +70° C
Transmission Performance	ISO/IEC 11801 Class EA AS/NZS 3080:2003 Class EA

MECHANICAL CHARACTERISTICS

Modular Connector	
RJ45 8-Pin Connector	FCC part 68, subpart F and IEC-60603-7 compliant
Durability	750 insertion cycles minimum
Material	Phosphor bronze with 50 micro-inches of gold over 100 micro-inches nickel plating
Format	30 mechanism shuttered
IDC Connector	
IDC Connector	Suitable insulation of 22 to 24 AWG (0.64 to 0.41mm)
Insulation Diameter (Wire)	0.70 - 1.60mm
Connector Material	Phosphor bronze with nickel plating
IDC Body and Cover Material	Fire-retardant UL 94V-0, plastic

PRODUCT FEATURES

- Fully compliant to AS/NZS 3080, ISO/IEC 11801, and ANSI/TIA/EIA-568-C Series.
- Backward compatible with Category 5e and Category 6 products.
- Flexible locking tabs.
- UL 940-0 rated.
- Accepts solid 22 - 24 AWG diameter conductors.
- Copper shielded shutter cap to eliminate alien crosstalk associated with Category 6A.
- Retaining cap supplied for added cable strain relief.

CUSTOMER BENEFITS

- Various colours for easier circuit identification.
- Can be used in Multi-User Telecommunication Outlet applications (MUTO) and Consolidation Points (CP).
- Clear insulation displacement connector caps allow for termination verification and assist in cable retention.



IP22 Rated

- Prevents dust ingress.
- Protects against insect infestation.

CATALOGUE NUMBER DESCRIPTION

30RJ45SMA6AS, (XX) Category 6A UTP RJ45 Connector, Shuttered, Suits Clipsal Wall Plates.

(XX) for Colour: White (WE), Black (BK), Blue (BU), Yellow (YL), Red (RD), Green (GR), Soft Grey (SG), Cream (CR) and Battleship Grey (GB).

Clipsal Category 6A UTP Jacks Shuttered Keystone

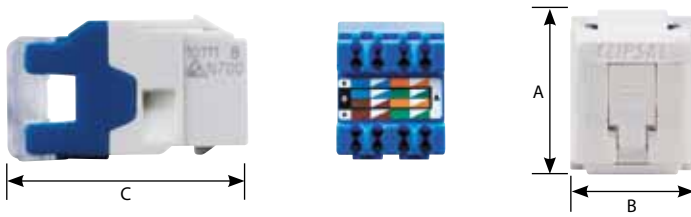

RJ45SMA6AS,WE

The Clipsal Category 6A UTP shuttered keystone jack is a superior product delivering the best network performance when used in conjunction with other products in this range.

The Clipsal range of products are the next generation of data communications solutions. These UTP modular jacks are colour coded for both 568A and 568B standards.

This shuttered keystone connector is designed to be terminated using a 110 tool (Clipsal 110 tool recommended, TRJ45PDT).

DIMENSIONS

Product	A (height)	B (width)	C (depth)
RJ45SMA6AS	23mm	15mm	36mm

COLOUR AVAILABILITY



ELECTRICAL CHARACTERISTICS

Dielectric Strength	1,000V RMS at 60Hz for 1 minute
Current Rating	1.5A maximum
Insulation Resistance	200MΩ minimum
Contact Resistance	1MΩ per contact
Temperature Range	-40° C to +70° C
Transmission Performance	Exceeds ISO/IEC 11801 Class EA AS/NZS 3080:2003 Class EA

MECHANICAL CHARACTERISTICS

Modular Connector	
RJ45 8-Pin Connector	FCC part 68, subpart F and IEC-60603-7 compliant
Durability	750 insertion cycles minimum
Material	Phosphor bronze with 50 micro-inches of gold over 100 micro-inches nickel plating
Format	Keystone shuttered
IDC Connector	
IDC Connector	Suitable insulation of 22 to 24 AWG (0.64 to 0.41mm)
Insulation Diameter (Wire)	0.70 - 1.60mm
Connector Material	Phosphor bronze with nickel plating
IDC Body and Cover Material	Fire-retardant UL 94V-0, plastic

PRODUCT FEATURES

- Fully compliant to AS/NZS 3080, ISO/IEC 11801, ANSI/TIA/EIA-568-C Series.
- Backward compatible with Category 5e and Category 6.
- UL 94V-0 rated.
- Accepts solid 22 - 24 AWG diameter conductors.

CUSTOMER BENEFITS

- Suitable for use with the Clipsal Category 6A UTP patch panel RJ6AU/24PP and RJ6AU/24PPS.
- Shutter mechanism is easy to operate, simply insert the plug lead into the jack.
- Protection from dust ingress, insect infestation and the insertion of foreign objects.
- Various colours for easier circuit identification.
- For use in Multi-User Telecommunication Outlet applications (MUTO).
- Clear insulation displacement connector caps allow for termination verification and assist in cable retention.



IP22 Rated

- Prevents dust ingress.
- Protects against insect infestation.

CATALOGUE NUMBER	DESCRIPTION
RJ45SMA6AS, (XX)	Category 6A UTP RJ45 Connector, Shuttered, Keystone
(XX) for Colour: White (WE), Black (BK), Blue (BU), Yellow (YL), Red (RD), Green (GR) and Soft Grey (SG)	

Clipsal Category 6A UTP Patch Panel 24-Port

The Clipsal range of patch panels feature individual Category 6A modular jacks that are colour coded for both 568A and 568B standards. This patch panel is loaded with 24 RJ45 Keystone Connectors.

This patch panel has been designed to be terminated using a 110 tool (Clipsal 110 tool recommended, TRJ45PDT).

Additional label refill sheets can be purchased separately, RJ6AU/24PPLS. Label printing software can be downloaded from clipsal.com/trade/downloads/software. This will enable you to print the labels onto the template.



RJ6AU/24PP

ELECTRICAL CHARACTERISTICS

Dielectric Strength	1,000V RMS at 60Hz for 1 minute
Current Rating	1.5A maximum
Insulation Resistance	200MΩ minimum
Contact Resistance	1MΩ per contact
Temperature Range	-40°C to +70°C
Transmission Performance	ISO/IEC 11801 Class EA AS/NZS 3080:2003 Class EA

MECHANICAL CHARACTERISTICS

Modular Connector	
RJ45 8-Pin Connector	FCC part 68, subpart F and IEC-60603-7 compliant
Durability	1000 mating cycles
Material	Phosphor bronze with 50 micro-inches of gold over 100 micro-inches nickel plating
IDC Connector	
IDC Connector	Suitable insulation of 22 to 24 AWG (0.64 to 0.41mm)
Insulation Diameter (Wire)	0.70 - 1.40mm
Durability	10 insertions of any combination of wire gauge (2 wires per slot)
Connector Material	Phosphor bronze with nickel plating
IDC Body and Cover Material	Fire-retardant, UL 94V-0, plastic

PRODUCT FEATURES

- Fully compliant to AS/NZS 3080, ISO/IEC 11801, and ANSI/TIA/EIA-568-B Series Connecting Hardware Standards.
- Staggered design to eliminate AXT.
- Powder coated metal framework.
- Universal colour coding for 568A and 568B Standards.
- Removable rear cable management tray.
- Compatible with standard 19" equipment frames.
- Individual removable modular jacks.
- Clear and flexible labeling system, numbered and blank sheets provided.

CUSTOMER BENEFITS

- Complete with all mounting and cable fixing hardware.
- Rear cable management tray is supplied loose, allowing the installer to fit after termination.
- The front labelling system provides a clear and efficient means of identifying circuits.
- Powder coated metal frame is robust and protects the patch panel from corrosion and scratching.
- Compliance with international standards gives the customer peace of mind that their network will perform to link, channel and application requirements.

DIMENSIONS

Product	A (height)	B (width)	C (depth)
RJ6AU/24PP	44mm	482mm	124mm

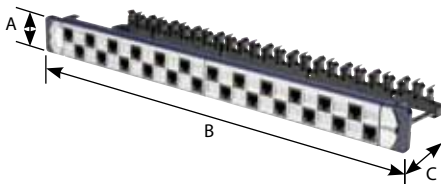

RJ6AU/24PP

CATALOGUE NUMBER	DESCRIPTION
RJ6AU/24PP	Patch Panel, 24 Port, Category 6A UTP, 568A/B
RJ6AU/24PPS	Patch Panel Shuttered, 24 Port, Category 6A UTP, 568A/B
RJ6AU/24PPLS	Patch Panel Label Refill Sheets, Suits Clipsal Category 6A (9 x 24 port patch panels labels)

Clipsal Category 6A UTP Cable

Clipsal 4-Pair Category 6A UTP cable delivers excellent network performance when used in conjunction with other Clipsal Category 6A UTP products.

The Category 6A UTP cable consists of 4-pairs of solid insulated copper 23 AWG (0.59mm) and is UL listed with a CM fire rating. It is designed for use in horizontal cabling situations and supplied in 305m (1,000ft) lengths.

The Category 6A UTP cable provides a significant margin above the minimum Category 6A near end crosstalk (NEXT) requirement of TIA/EIA 568-B.3-1 and ISO/IEC 11801.



2D4P6AIPV3R,BU

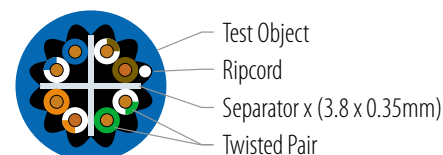

PHYSICAL SPECIFICATIONS

Rated Temperature (°C)	75
Product Standard Certification	UL File E197794
Flammability Test	CM
Application	Horizontal wiring in LAN
Reference Standard	EIA/TIA568 and ISO/IEC 11801, IEC61156-5
NVP %	65

CONSTRUCTION

Conductor	Solid bare copper
AWG	23
Conductor Diameter Nom. (mm)	0.59
Insulation	PE
Average Thickness (mm)	0.27
Min. Point Thickness (mm)	0.18
Insulation Diameter (±0.10mm)	1.15
Filler	PE
Jacket	PVC
Ripcord	Yes
Outer Diameter (mm)	8.5

MECHANICAL CHARACTERISTICS

Test Object	Jacket
Test Material	PVC
Before Tensile Strength (Kg/mm ²)	≥1.05
Bend radius (mm)	
Installed	75
After Installed	40
Pulling Tension	110N (25lbf)
Storage Temp	-20° to 75°
Operating Temp	-20° to 75°
Installation Temp	0° to 58°

ELECTRICAL CHARACTERISTICS

Frequency (MHz)	Attenuation (dB/100m)	NEXT (dB)	PSNEXT (dB)	ELFEXT (dB/100m)	PSELFEXT (dB/100m)	RL	Delay	PSANEXT	PSAACRF
1	2.1	74.3	72.3	67.8	64.8	20.0	570	67.0	67.0
4	3.8	65.3	63.3	55.8	52.8	23.0	552	67.0	66.2
8	5.3	60.8	58.8	49.7	46.7	24.5	547	67.0	60.1
10	5.9	59.3	57.3	47.8	44.8	25.0	545	67.0	58.2
16	7.5	56.2	54.2	43.7	40.7	25.0	543	67.0	54.1
20	8.4	54.8	52.8	41.8	38.8	25.0	542	67.0	52.2
25	9.4	53.3	51.3	39.8	36.8	24.3	541	67.0	50.2
31.25	10.5	51.9	49.9	37.9	34.9	23.6	540	67.0	48.3
62.50	15.0	47.4	45.4	31.9	28.9	21.5	539	65.6	42.3
100	19.1	44.3	42.3	27.8	24.8	20.1	538	62.5	38.2
200	27.6	39.8	37.8	21.8	18.8	18.0	567	58.0	32.2
250	31.1	38.8	36.6	19.8	16.8	17.3	536	56.5	30.2
300	34.3	37.1	35.1	18.3	15.3	16.8	536	55.3	28.7
400	40.1	35.3	35.1	15.8	12.8	15.9	536	53.5	26.2
500	45.3	33.8	31.8	13.8	10.8	15.2	536	52.0	24.2

Characteristic Impedance (Ohms)	100 ± 15
1.0-500.0MHz Delay Skew (ns/100m)	≤45
Pair-to-ground Capacitance Unbalance (pF/100m)	≤330
Max. Conductor DC Resistance 20°C (Ohms/km)	72
DC Resistance Unbalanced Max (%)	5

CATALOGUE NUMBER	DESCRIPTION
2D4P6AIPV3R,BU	LAN Cable Category 6A UTP 4 Pair, 305m Reel (Blue only)

Clipsal Cable Management Panel Deep

The Clipsal cable management panel is a 1 rack unit (1RU) item designed for use in 19" rack environments, managing patch cords that are connected between patch panels and/or active switches. The product is recommended for mounting between every second row of patch panels/active switches.

The unique clips provide a quick and simple means of installing the panel in the rack or cabinet. The rings have been designed to facilitate easy insertion and removal of the patch leads, necessary in dynamic environments where moves and changes are required.

DIMENSIONS

Product	A (height)	B (width)	C (depth)
RJ1UCMPC	44mm	482mm	100mm



RJ1UCMPC

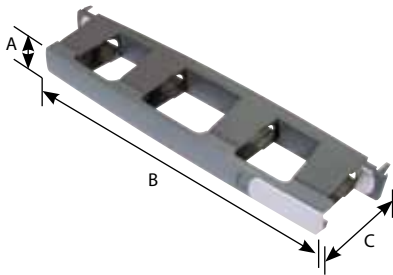

RJ1UCMPC



Rack clips for easy mounting



Reinforced cable rings

PRODUCT FEATURES

- Clip-on cover (patented).
- Rack mount clips eliminate the need for cage nuts and screws.
- Cavities behind each ring provide additional space for cable slack.
- Additional depth on cable rings ensures compliance with minimum bend radius requirements.

CUSTOMER BENEFITS

- Quick product installation using rack mount clips.

CATALOGUE NUMBER	DESCRIPTION
RJ1UCMPC	1RU Cable Management Panel, Deep

Clipsal Side Rings

The side rings are typically used in frames or cabinets to provide vertical patch cord management. These rings have several features that make them stand out. The “ring and lock” design utilises proven plastic hinge technology to guide patch cords. These rings have unique teeth locks that are easy to open and snap back to lock tight again, should you need to open the rings.

The rings can be mounted with patch panels or directly onto the vertical panel mounts (VPM) of the equipment frame.

MECHANICAL CHARACTERISTICS

Test Object	Jacket
Ring Material	Polypropylene, Graphite Grey

DIMENSIONS

Product	A (height)	B (width)	C (depth)
RJ1HUSSR	42mm	43mm	65mm
RJ1HUDSR	42mm	43mm	130mm

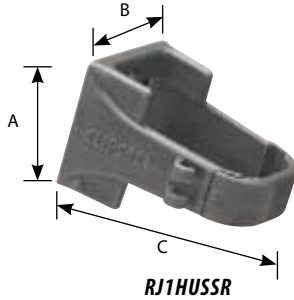
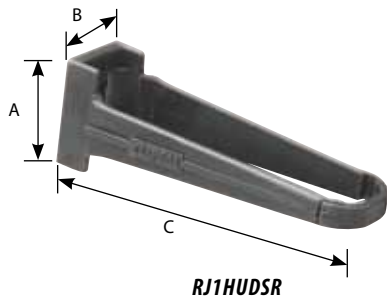

RJ1HUDSR



RJ1HUSSR

PRODUCT FEATURES

- Graphite Grey.
- Teeth locks that provide easy access and security for patch cords.
- Available in a deep and shallow version.

CUSTOMER BENEFITS

- The “ring and lock” design not only makes the loading and unloading of patch cords or cables easier but also secures them in place. This keeps the cabinet neat and uncluttered. Circuit identification and administration for the customer is also far more efficient.
- The different two ring depths enable the customer to manage the cabinet or rack better, depending on the amount of patch cords being used.

CATALOGUE NUMBER	DESCRIPTION
RJ1HUSSR	1RU Side Ring, Shallow
RJ1HUDSR	1RU Side Ring, Deep

WALL PLATES AND LABELLING

Saturn
Slimline
Eclipse
C2000 Series
2000 Series
Flush Mounting Accessories
Clipsal Labelling

Saturn™ Wall Plates

Clipsal Saturn is a premium range of architecturally designed electrical accessories. Especially appealing to those who desire the latest styles and fashions, the entire range has set new standards in home electrical accessories. Offering switch and accessory design that is unlike any other 250V electrical accessory range on the market, Clipsal Saturn is specially designed to offer a seamless electrical solution home or office.

When you see the diversity of the Clipsal Saturn range you'll be amazed how it will complement every room. The Clipsal Saturn range offers a complete electrical accessory solution that gives superior functionality while enhancing your décor.



4031VH, EB



4031VH, OM



4031VH, PW

CATALOGUE NUMBER	DESCRIPTION
4031VH	Grid and Cover Assembly, 1 Gang, Less Mechanism
4032VH	Grid and Cover Assembly, 2 Gang, Less Mechanism
4033VH	Grid and Cover Assembly, 3 Gang, Less Mechanism
4034VH	Grid and Cover Assembly, 4 Gang, Less Mechanism
4036VH	Grid and Cover Assembly, 6 Gang, Less Mechanism

Colours: (EB) Espresso Black, (OM) Ocean Mist, (PW) Pure White

Slimline® Series Wall Plates

Clipsal's range of Slimline switches and sockets have the same size dimensions as the Classic range, but are only 4mm thick, making them the thinnest switch plates in the world. Not only does the low profile design of Slimline appeal to customers, but they also have less impact on the environment because they only use one third of the plastics in manufacturing.

Slimline offers a comprehensive range of switch and socket options, but still looks at home when used with the Classic range. Like the Classic, Slimline is also available with metal plate and Chrome Shadow cover options, featuring a full metal look with a fingerprint resistant finish.



SC2032VH



SC2034VHI



Wall Plate Loaded

CATALOGUE NUMBER	DESCRIPTION
SC2031VH	Grid and Cover Assembly, 1 Gang, Less Mechanism
SC2032VH	Grid and Cover Assembly, 2 Gang, Less Mechanism
SC2033VH	Grid and Cover Assembly, 3 Gang, Less Mechanism
SC2034VH	Grid and Cover Assembly, 4 Gang, Less Mechanism
SC2035VH	Grid and Cover Assembly, 5 Gang, Less Mechanism
SC2036VH	Grid and Cover Assembly, 6 Gang, Less Mechanism
SC2031VHI	Grid and Cover Assembly, 1 Gang, Less Mechanism with ID Kit
SC2032VHI	Grid and Cover Assembly, 2 Gang, Less Mechanism with ID Kit
SC2033VHI	Grid and Cover Assembly, 3 Gang, Less Mechanism with ID Kit
SC2034VHI	Grid and Cover Assembly, 4 Gang, Less Mechanism with ID Kit
SC2035VHI	Grid and Cover Assembly, 5 Gang, Less Mechanism with ID Kit
SC2036VHI	Grid and Cover Assembly, 6 Gang, Less Mechanism with ID Kit

Eclipse® Wall Plates

Over 90 years of evolution has kept Clipsal electrical products at the cutting edge of technology.

With a remarkably thin 4mm profile, they are up to 60% thinner than other outlets.

It is this understated design that truly distinguishes the Eclipse range from other products on offer. The sleek elegance of Eclipse rests smoothly on any surface to ensure a slim and highly fashionable finish.



SL2031VH



SL2032VHI

CATALOGUE NUMBER	DESCRIPTION
SL2031VH	Grid and Cover Assembly, 1 Gang, Less Mechanism
SL2032VH	Grid and Cover Assembly, 2 Gang, Less Mechanism
SL2033VH	Grid and Cover Assembly, 3 Gang, Less Mechanism
SL2034VH	Grid and Cover Assembly, 4 Gang, Less Mechanism
SL2035VH	Grid and Cover Assembly, 5 Gang, Less Mechanism
SL2036VH	Grid and Cover Assembly, 6 Gang, Less Mechanism
SL2031VHI	Grid and Cover Assembly, 1 Gang, Less Mechanism with ID Kit
SL2032VHI	Grid and Cover Assembly, 2 Gang, Less Mechanism with ID Kit
SL2033VHI	Grid and Cover Assembly, 3 Gang, Less Mechanism with ID Kit
SL2034VHI	Grid and Cover Assembly, 4 Gang, Less Mechanism with ID Kit
SL2035VHI	Grid and Cover Assembly, 5 Gang, Less Mechanism with ID Kit
SL2036VHI	Grid and Cover Assembly, 6 Gang, Less Mechanism with ID Kit

C2000 Series® Wall Plates

The smooth curves and sleek lines of the C2000 Series reflects the latest interior design trends. The C2000 Series is ideal for the budget conscious, offering a level of elegance and quality that you would expect from electrical switches and power outlets costing much more.

The C2000 Series is available in a comprehensive range of colours. The grid plates are easily interchangeable, so they will complement any home interior and décor. They are also available with metal plate, Chrome Shadow and Arctic Silver cover options, featuring a full metal look with a fingerprint resistant finish.

C2000 SERIES LABELLING

C2000 Classic Series face plates are available with labelling ID windows, in either horizontal or vertical alignment, so that circuits can be easily identified. The clear label window cover simply clips into the grid.



C2034VH

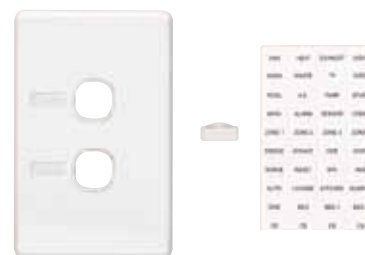

C2032VI

CATALOGUE NUMBER	DESCRIPTION
C2031VH	Grid and Cover Assembly, 1 Gang, Less Mechanism
C2031VX	Grid and Cover Assembly - Blank
C2032VH	Grid and Cover Assembly, 2 Gang, Less Mechanism
C2033VH	Grid and Cover Assembly, 3 Gang, Less Mechanism
C2034VH	Grid and Cover Assembly, 4 Gang, Less Mechanism
C2035VH	Grid and Cover Assembly, 5 Gang, Less Mechanism
C2036VH	Grid and Cover Assembly, 6 Gang, Less Mechanism
C2031VI	Grid and Cover Assembly, 1 Gang, Less Mechanism - Vertical Mount
C2031HI	Grid and Cover Assembly, 1 Gang, Less Mechanism - Horizontal Mount
C2032VI	Grid and Cover Assembly, 2 Gang, Less Mechanism - Vertical Mount
C2032HI	Grid and Cover Assembly, 2 Gang, Less Mechanism - Horizontal Mount
C2033VI	Grid and Cover Assembly, 3 Gang, Less Mechanism - Vertical Mount
C2033HI	Grid and Cover Assembly, 3 Gang, Less Mechanism - Horizontal Mount
C2034VI	Grid and Cover Assembly, 4 Gang, Less Mechanism - Vertical Mount
C2034HI	Grid and Cover Assembly, 4 Gang, Less Mechanism - Horizontal Mount
C2035VI	Grid and Cover Assembly, 5 Gang, Less Mechanism - Vertical Mount
C2035HI	Grid and Cover Assembly, 5 Gang, Less Mechanism - Horizontal Mount
C2036VI	Grid and Cover Assembly, 6 Gang, Less Mechanism - Vertical Mount
C2036HI	Grid and Cover Assembly, 6 Gang, Less Mechanism - Horizontal Mount

2000 Series™ Wall Plates

Clipsal 2000 Series has celebrated more than a decade of innovative design and performance.

In fact, the contemporary styling and flexibility of the 2000 Series have made it Clipsal's most popular range of switches and sockets.

The feature that sets the 2000 Series apart from any other range is its unique grid assembly and surround, which come in a comprehensive range of colours.

The 2000 Series also offers you the flexibility of an extensive product range that includes dimmers, fan speed controllers, time delays, room access card-operated switches and weatherprotected switches.

With unsurpassed versatility and reliability, it's not surprising that the 2000 Series continues to be so popular.



2031VH



2034VH

CATALOGUE NUMBER	DESCRIPTION
2031VH	Flush Surround and 1 Gang Grid
2032VH	Flush Surround and 2 Gang Grid
2033VH	Flush Surround and 3 Gang Grid
2034VH	Flush Surround and 4 Gang Grid
2035VH	Flush Surround and 5 Gang Grid
2036VH	Flush Surround and 6 Gang Grid

Flush Mounting Accessories

The Clipsal range of flush mounting accessories is a collection of wall plates complete with Category 5e socket mechanisms.



2031VRJA5

CATALOGUE NUMBER	DESCRIPTION
2031VRJA5	Data Outlet 1 Gang with RJ45 Category 5e (100Mbs) Socket Mechanism
2032VRJA5	Data Outlet 2 Gang with RJ45 Category 5e (100Mbs) Socket Mechanism

Clipsal Labelling

Clear identification of services is an essential part of a structured cabling solution. It saves time and money down the track when additions, moves and changes are made.

The Clipsal label printing package is designed for the C2000 Classic Series, Slimline and Eclipse labelling series and 30PID labels. It is available free at <http://www.clipsal.com/label> or as part of the e-Catalogue, and enables contractors and customers to quickly and easily print their own labels. The CD contains an extensive tutorial which fully explains how to print labels.

The Clipsal label software package is Windows based. It requires very simple data entry, and allows for multiples of consecutive labels. Text colour selection is also available, depending on the suitability of the printer. The program provides a test and setting adjustment facility which allows for different brands of printers.

The Clipsal label printer programme ensures perfect labels every time, when printing on the special C2000 or 30PID label sheets.

This label programme has been updated to include on site labelling for the Clipsal Category 5e, Category 6, Category 6A patch panels and data block cabling solution.



30PID



30PIDA4L



CATALOGUE NUMBER	DESCRIPTION
30PIDA4L	A4 Label Sheet to Suit 30PID Circuit Identifier for 30 Series Apertures
C2000A4L	A4 Label Sheet to Suit C2000 ID Label Face Plates
30PID	30 Series ID Circuit Plug



OPTICAL FIBRE SOLUTION

Fibre Management Trays

Fibre Adaptor Panels

Fibre Patch Cords

Fibre Pigtails

Indoor/Outdoor Optical Fibre Cables

Underground Optical Fibre Cables

Clipsal Fibre Tray - Sliding

The Clipsal fibre tray (sliding) is a superior and compact fibre termination solution. It provides a rack/cabinet mountable solution with a provision to splice up to 48 fibres to 48 pigtails.

Installed with a pair of cable radius guides, this tray can also facilitate a maximum of 24 fibre patching applications. This powder coated steel enclosure comes with a tinted removable Plexiglass cover for ease of installation, inspection and testing. Innovated design, such as slide in/out cable entry, provides additional flexibility during installation, movement or changes in the future.

Designed with multiple applications in mind, the Clipsal fibre management tray can accommodate different types of modular adapter panels and splice trays to give outstanding performance and functionality.

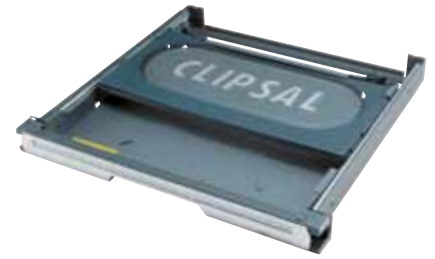

TFM1U

TECHNICAL SPECIFICATIONS

Material	Powder coated mild steel
Accommodation Ports	Up to 24 x ST connectors Up to 24 x SC connectors Up to 48 LC connectors
Cable Termination	Direct termination
Options	Mechanical and fusion splicing

DIMENSIONS

Product	A (width)	B (depth)	C (height)
TFM1U	482mm	480mm	44mm

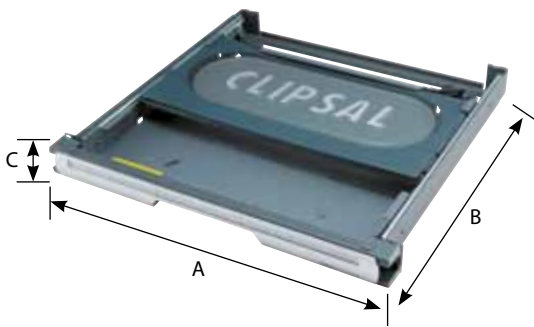

PRODUCT FEATURES

- 19" front rack mounting tray provides patching and fibre slack storage capability, conduit or standard tube interfacing.
- Splice cassette included.
- Accommodates up to three connector panels.
- Access connector panel with front quick release latch cover.
- Nylon cable radius guides and centre strength member clamps.
- Cable fibre track cover provides additional protection and a clean outlook.
- Clear, easy access slide-out and removable Plexiglass cover.
- Accommodates both single-mode and multi-mode fibre.
- Additional rear mount ears (a set of two) for cabinet mounting.
- Rugged steel construction in graphite finish.
- Slide in cable entry panel with 2 x 25mm diameter holes.

CUSTOMER BENEFITS

- Provide patching and fibre slack storage capability with technicians and users in mind.
- The technician's side has facilities for securing the cable storing fibre slack and arranging the terminated fibres.
- The user's side has similar features for the management of fibre optic patch cord.
- 66mm deep front cable panel for patch cord management and protection.
- Slide-out, medium density, optical fibre management enclosure for optimum access; providing easy installation, inspection and testing.
- Slide-in cable entry panel with 2 x 25mm diameter holes allow flexible conduit or standard tube interfacing during installation.
- Nylon cable radius guide within the enclosure to accommodate excess fibres while maintaining fibre bend radius.
- Cable fibre track cover to give additional protection and clean outlook.

CATALOGUE NUMBER DESCRIPTION

TFM1U 1RU Sliding Fibre Tray, Unloaded (splice cassette included)

Clipsal Fibre Tray - Fixed

The Clipsal fibre tray (fixed) is a superior and compact fibre termination solution. It provides a rack/cabinet mountable solution with a provision to splice up to 48 fibres to 48 pigtails.

Installed with a pair of cable radius guides, this tray can also facilitate a maximum of 24 fibre patching applications. This powder coated steel tray comes with a tinted removable Plexiglass cover for ease of installation, inspection and testing. Innovated design, such as slide in/out cable entry, provides additional flexibility during installation, movement or changes in the future.

Designed with multiple applications in mind, the Clipsal fibre management tray can accommodate different types of modular adapter panels and splice trays (optional) to give outstanding performance and functionality.



TFM1UF

TECHNICAL SPECIFICATIONS

Material	Powder coated mild steel
Accommodation Ports	Up to 24 x ST connectors Up to 24 x SC connectors Up to 48 LC connectors
Cable Termination	Direct termination
Options	Mechanical and fusion splicing

DIMENSIONS

Product	A (width)	B (depth)	C (height)
TFM1UF	482mm	280mm	44mm

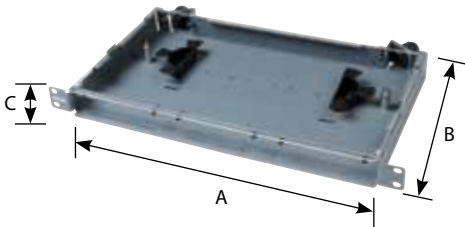

PRODUCT FEATURES

- 19" front rack mounting enclosure provides patching and fibre slack storage.
- Accommodates up to three connector panels.
- Nylon cable radius guides and centre strength member clamps.
- Cable fibre track cover provides additional protection and a clean outlook.
- Clear, easy access slide-out and removable Plexiglass cover.
- Accommodates both single-mode and multi-mode fibre.
- Rugged steel construction in graphite finish.
- Optional splice cassette can be mounted to the unit.

CUSTOMER BENEFITS

- Provide patching and fibre slack storage capability with technicians and users in mind.
- The technician's side has facilities for securing the cable storing fibre slack and arranging the terminated fibres.
- The user's side has similar features for the management of fibre optic patch cords.
- Nylon cable radius guide within the enclosure to accommodate excess fibres while maintaining fibre bend radius.
- Optional splice cassette can be mounted to manage and protect either fusion or mechanical splices.

CATALOGUE NUMBER	DESCRIPTION
TFM1UF	1RU Fixed Fiber Tray, Unloaded
TFMSPT	Splicing Cassette, Suits TFM1UF and TFM1U

Clipsal Fibre Adaptor Panels

The Clipsal fibre adaptor panels are available in LC, SC and ST configurations. The fibre adaptors are colour coded to differentiate between single mode (Blue) and multi-mode (Beige). Offered in simplex and duplex varieties, they have been manufactured to suit the extensive range of Clipsal titanium® fibre patch cords and pigtails.

As an integral part of the Clipsal Fibre Optic Series, these products have a lifetime warranty and system performance guarantee when installed by a Clipsal Certified Installer or Endorsed Partner.



TFM1ULCD8P

TECHNICAL SPECIFICATIONS

Material	Zirconia Ceramic
-----------------	------------------

PRODUCT FEATURES

- Adaptors are available as simplex (ST) or duplex.
- All adaptors are compliant to AS/NZS 3080:2003.
- Suits Clipsal TFM1U and TFM1UF fibre trays.

CUSTOMER BENEFITS

- High quality materials gives customers confidence in the products performance.
- Compliant to local and international standards.

CATALOGUE NUMBER	DESCRIPTION
TFM1UBLANKP	Blank Connector Panel
TFM1ULCD4P	LC Duplex Panel, Comes with 4 Adaptors
TFM1ULCD8P	LC Duplex Panel, Comes with 8 Adaptors
TFM1USCD4P	SC Duplex Panel, Comes with 4 Adaptors
TFM1USTS8P	ST Simplex Panel, Comes with 8 Adaptors

Single Mode Patch Cords - OS1 9/125µm

The Clipsal fibre optic patch cords are a superior product, delivering the best network performance when used in conjunction with other Clipsal Datacomms Fibre Optic products.

Clipsal offers a complete range of patch cords in a wide variety of configurations, all constructed with high quality materials.

As an integral part of the Clipsal Datacomms Fibre Optic Series, these products have a lifetime warranty and system performance guarantee when installed by a Clipsal Certified Installer or Endorsed Partner.



TFP2L3S19S10

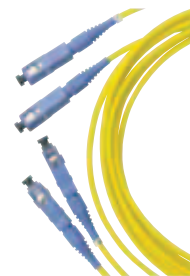

TFP2C3S19S10



TFP2T3S19S10

CATALOGUE NUMBER	DESCRIPTION
SC Single Mode Patch Cord - OS1 9/125µm	
TFP1C3S19S05	Patch Cord SC Simplex OS1 SM 0.5m
TFP1C3S19S10	Patch Cord SC Simplex OS1 SM 1.0m
TFP1C3S19S20	Patch Cord SC Simplex OS1 SM 2.0m
TFP1C3S19S50	Patch Cord SC Simplex OS1 SM 5.0m
TFP1C3S19S100	Patch Cord SC Simplex OS1 SM 10.0m
TFP2C3S19S05	Patch Cord SC Duplex OS1 SM 0.5m
TFP2C3S19S10	Patch Cord SC Duplex OS1 SM 1.0m
TFP2C3S19S20	Patch Cord SC Duplex OS1 SM 2.0m
TFP2C3S19S50	Patch Cord SC Duplex OS1 SM 5.0m
TFP2C3S19S100	Patch Cord SC Duplex OS1 SM 10.0m
ST Single Mode Patch Cord - OS1 9/125µm	
TFP1T3S19S05	Patch Cord ST Simplex OS1 SM 0.5m
TFP1T3S19S10	Patch Cord ST Simplex OS1 SM 1.0m
TFP1T3S19S20	Patch Cord ST Simplex OS1 SM 2.0m
TFP1T3S19S50	Patch Cord ST Simplex OS1 SM 5.0m
TFP1T3S19S100	Patch Cord ST Simplex OS1 SM 10.0m
TFP2T3S19S05	Patch Cord ST Duplex OS1 SM 0.5m
TFP2T3S19S10	Patch Cord ST Duplex OS1 SM 1.0m
TFP2T3S19S20	Patch Cord ST Duplex OS1 SM 2.0m
TFP2T3S19S50	Patch Cord ST Duplex OS1 SM 5.0m
TFP2T3S19S100	Patch Cord ST Duplex OS1 SM 10.0m
LC Single Mode Patch Cord - OS1 9/125µm	
TFP1L3S19S05	Patch Cord LC Simplex OS1 SM 0.5m
TFP1L3S19S10	Patch Cord LC Simplex OS1 SM 1.0m
TFP1L3S19S20	Patch Cord LC Simplex OS1 SM 2.0m
TFP1L3S19S50	Patch Cord LC Simplex OS1 SM 5.0m
TFP1L3S19S100	Patch Cord LC Simplex OS1 SM 10.0m
TFP2L3S19S05	Patch Cord LC Duplex OS1 SM 0.5m
TFP2L3S19S10	Patch Cord LC Duplex OS1 SM 1.0m
TFP2L3S19S20	Patch Cord LC Duplex OS1 SM 2.0m
TFP2L3S19S50	Patch Cord LC Duplex OS1 SM 5.0m
TFP2L3S19S100	Patch Cord LC Duplex OS1 SM 10.0m

PRODUCT FEATURES

- Available in several lengths.
- Factory terminated.
- Cords are easy to install and environmentally stable.
- AS/NZS 3080: 2003 standard compliant.
- Colour coded cable and adaptors for single mode applications.

CUSTOMER BENEFITS

- The various lengths allow for easier cable management.
- Compliant to local and international standards.

Multi Mode Patch Cords - OM1 62.5/125µm

The Clipsal fibre optic patch cords are a superior product, delivering the best network performance when used in conjunction with other Clipsal Datacomms Fibre Optic products.

Clipsal offers a complete range of multi-mode patch cords in a wide variety of configurations, all constructed with high quality materials.

As an integral part of the Clipsal Datacomms Fibre Optic Series, these products have a lifetime warranty and system performance guarantee when installed by a Clipsal Certified Installer or Endorsed Partner.



TFP2C3M16M10



TFP2T3M16M20



TFP2L3M16M05

CATALOGUE NUMBER	DESCRIPTION
SC Multi Mode Patch Cords - OM1 62.5/125µm	
TFP1C3M16M05	Patch Cord SC Simplex OM1 MM 0.5m
TFP1C3M16M10	Patch Cord SC Simplex OM1 MM 1.0m
TFP1C3M16M20	Patch Cord SC Simplex OM1 MM 2.0m
TFP1C3M16M50	Patch Cord SC Simplex OM1 MM 5.0m
TFP1C3M16M100	Patch Cord SC Simplex OM1 MM 10.0m
TFP2C3M16M05	Patch Cord SC Duplex OM1 MM 0.5m
TFP2C3M16M10	Patch Cord SC Duplex OM1 MM 1.0m
TFP2C3M16M20	Patch Cord SC Duplex OM1 MM 2.0m
TFP2C3M16M50	Patch Cord SC Duplex OM1 MM 5.0m
TFP2C3M16M100	Patch Cord SC Duplex OM1 MM 10.0m
ST Multi Mode Patch Cords - OM1 62.5/125µm	
TFP1T3M16M05	Patch Cord ST Simplex OM1 MM 0.5m
TFP1T3M16M10	Patch Cord ST Simplex OM1 MM 1.0m
TFP1T3M16M20	Patch Cord ST Simplex OM1 MM 2.0m
TFP1T3M16M50	Patch Cord ST Simplex OM1 MM 5.0m
TFP1T3M16M100	Patch Cord ST Simplex OM1 MM 10.0m
TFP2T3M16M05	Patch Cord ST Duplex OM1 MM 0.5m
TFP2T3M16M10	Patch Cord ST Duplex OM1 MM 1.0m
TFP2T3M16M20	Patch Cord ST Duplex OM1 MM 2.0m
TFP2T3M16M50	Patch Cord ST Duplex OM1 MM 5.0m
TFP2T3M16M100	Patch Cord ST Duplex OM1 MM 10.0m
LC Multi Mode Patch Cords - OM1 62.5/125µm	
TFP2L3M16M05	Patch Cord LC Duplex OM1 MM 0.5m
TFP2L3M16M10	Patch Cord LC Duplex OM1 MM 1.0m
TFP2L3M16M20	Patch Cord LC Duplex OM1 MM 2.0m
TFP2L3M16M50	Patch Cord LC Duplex OM1 MM 5.0m
TFP2L3M16M100	Patch Cord LC Duplex OM1 MM 10.0m

PRODUCT FEATURES

- Available in several lengths.
- Factory terminated.
- Cords are easy to install and environmentally stable.
- AS/NZS 3080: 2003 standard compliant.
- Colour coded cable and adaptors for single mode applications.

CUSTOMER BENEFITS

- The various lengths allow for easier cable management.
- Compliant to local and international standards.

Multi Mode Patch Cords - OM1 62.5/125µm

The Clipsal fibre optic patch cords are a superior product, delivering the best network performance when used in conjunction with other Clipsal Datacomms Fibre Optic products.

Clipsal offers a complete range of multi-mode patch cords in a wide variety of configurations, all constructed with high quality materials.

As an integral part of the Clipsal Datacomms Fibre Optic Series, these products have a lifetime warranty and system performance guarantee when installed by a Clipsal Certified Installer or Endorsed Partner.



TFP2TC3M16M20



TFP2CL3M16M20

PRODUCT FEATURES

- Available in several lengths.
- Factory terminated.
- Cords are easy to install and environmentally stable.
- AS/NZS 3080: 2003 standard compliant.
- Colour coded cable and adaptors for single mode applications.

CUSTOMER BENEFITS

- The various lengths allow for easier cable management.
- Compliant to local and international standards.

CATALOGUE NUMBER	DESCRIPTION
SC-LC Multi Mode Patch Cords - OM1 62.5/125µm	
TFP2CL3M16M05	Patch Cord SC-LC Duplex OM1 MM 0.5m
TFP2CL3M16M10	Patch Cord SC-LC Duplex OM1 MM 1.0m
TFP2CL3M16M20	Patch Cord SC-LC Duplex OM1 MM 2.0m
TFP2CL3M16M50	Patch Cord SC-LC Duplex OM1 MM 5.0m
TFP2CL3M16M100	Patch Cord SC-LC Duplex OM1 MM 10.0m
ST-SC Multi Mode Patch Cords - OM1 62.5/125µm	
TFP2TC3M16M05	Patch Cord ST-SC Duplex OM1 MM 0.5m
TFP2TC3M16M10	Patch Cord ST-SC Duplex OM1 MM 1.0m
TFP2TC3M16M20	Patch Cord ST-SC Duplex OM1 MM 2.0m
TFP2TC3M16M50	Patch Cord ST-SC Duplex OM1 MM 5.0m
TFP2TC3M16M100	Patch Cord ST-SC Duplex OM1 MM 10.0m

Multi Mode Patch Cords - OM3 50/125µm

The Clipsal fibre optic patch cords are a superior product, delivering the best network performance when used in conjunction with other Clipsal Datacomms Fibre Optic products.

Clipsal offers a complete range of multi-mode patch cords in a wide variety of configurations, all constructed with high quality materials.

As an integral part of the Clipsal Datacomms Fibre Optic Series, these products have a lifetime warranty and system performance guarantee when installed by a Clipsal Certified Installer or Endorsed Partner.



TFP2L3M35M20

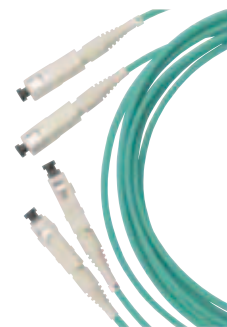

TFP2C3M35M20



TFP2T3M35M10

CATALOGUE NUMBER	DESCRIPTION
SC Multi Mode Patch Cord - OM3 50/125µm	
TFP1C3M35M05	Patch Cord ST Simplex OM3 MM 0.5m
TFP1C3M35M10	Patch Cord ST Simplex OM3 MM 1.0m
TFP1C3M35M20	Patch Cord ST Simplex OM3 MM 2.0m
TFP1C3M35M50	Patch Cord ST Simplex OM3 MM 5.0m
TFP1C3M35M100	Patch Cord ST Simplex OM3 MM 10.0m
TFP2C3M35M05	Patch Cord ST Duplex OM3 MM 0.5m
TFP2C3M35M10	Patch Cord ST Duplex OM3 MM 1.0m
TFP2C3M35M20	Patch Cord ST Duplex OM3 MM 2.0m
TFP2C3M35M50	Patch Cord ST Duplex OM3 MM 5.0m
TFP2C3M35M100	Patch Cord ST Duplex OM3 MM 10.0m
ST Multi Mode Patch Cord - OM3 50/125µm	
TFP1T3M35M05	Patch Cord ST Simplex OM3 MM 0.5m
TFP1T3M35M10	Patch Cord ST Simplex OM3 MM 1.0m
TFP1T3M35M20	Patch Cord ST Simplex OM3 MM 2.0m
TFP1T3M35M50	Patch Cord ST Simplex OM3 MM 5.0m
TFP1T3M35M100	Patch Cord ST Simplex OM3 MM 10.0m
TFP2T3M35M05	Patch Cord ST Duplex OM3 MM 0.5m
TFP2T3M35M10	Patch Cord ST Duplex OM3 MM 1.0m
TFP2T3M35M20	Patch Cord ST Duplex OM3 MM 2.0m
TFP2T3M35M50	Patch Cord ST Duplex OM3 MM 5.0m
TFP2T3M35M100	Patch Cord ST Duplex OM3 MM 10.0m
LC Multi Mode Patch Cord - OM3 50/125µm	
TFP2L3M35M05	Patch Cord LC Duplex OM3 MM 0.5m
TFP2L3M35M10	Patch Cord LC Duplex OM3 MM 1.0m
TFP2L3M35M20	Patch Cord LC Duplex OM3 MM 2.0m
TFP2L3M35M50	Patch Cord LC Duplex OM3 MM 5.0m
TFP2L3M35M100	Patch Cord LC Duplex OM3 MM 10.0m

PRODUCT FEATURES

- Available in several lengths.
- Factory terminated.
- Cords are easy to install and environmentally stable.
- AS/NZS 3080: 2003 standard compliant.
- Colour coded cable and adaptors for single mode applications.

CUSTOMER BENEFITS

- The various lengths allow for easier cable management.
- Compliant to local and international standards.

Multi Mode Patch Cords - OM3 50/125µm

The Clipsal fibre optic patch cords are a superior product, delivering the best network performance when used in conjunction with other Clipsal Datacomms Fibre Optic products.

Clipsal offers a complete range of multi-mode patch cords in a wide variety of configurations, all constructed with high quality materials.

As an integral part of the Clipsal Datacomms Fibre Optic Series, these products have a lifetime warranty and system performance guarantee when installed by a Clipsal Certified Installer or Endorsed Partner.



TFP2TC3M35M20



TFP2CL35M20

PRODUCT FEATURES

- Available in several lengths.
- Factory terminated.
- Cords are easy to install and environmentally stable.
- AS/NZS 3080: 2003 standard compliant.
- Colour coded cable and adaptors for single mode applications.

CUSTOMER BENEFITS

- The various lengths allow for easier cable management.
- Compliant to local and international standards.

CATALOGUE NUMBER	DESCRIPTION
SC-LC Multi Mode Patch Cord - OM3 50/125µm	
TFP2CL3M35M05	Patch Cord SC-LC Duplex OM3 MM 0.5m
TFP2CL3M35M10	Patch Cord SC-LC Duplex OM3 MM 1.0m
TFP2CL3M35M20	Patch Cord SC-LC Duplex OM3 MM 2.0m
TFP2CL3M35M50	Patch Cord SC-LC Duplex OM3 MM 5.0m
TFP2CL3M35M100	Patch Cord SC-LC Duplex OM3 MM 10.0m
ST-SC Multi Mode Patch Cord - OM3 50/125µm	
TFP2TC3M35M05	Patch Cord ST-SC Duplex OM3 MM 0.5m
TFP2TC3M35M10	Patch Cord ST-SC Duplex OM3 MM 1.0m
TFP2TC3M35M20	Patch Cord ST-SC Duplex OM3 MM 2.0m
TFP2TC3M35M50	Patch Cord ST-SC Duplex OM3 MM 5.0m
TFP2TC3M35M100	Patch Cord ST-SC Duplex OM3 MM 10.0m

Fibre Pigtails

The Clipsal fibre optic pigtails are a superior product, delivering the best network performance when used in conjunction with other Clipsal Datacomms Fibre Optic products.

Clipsal offers a complete range of pigtails in a wide variety of configurations, all constructed with high quality materials.

As an integral part of the Clipsal Datacomms Fibre Optic Series, these products have a lifetime warranty and system performance guarantee when installed by a Clipsal Certified Installer or Endorsed Partner.



TFT1C3M35M10



TFT1T3S19S10



TFT1L3M16M10

CATALOGUE NUMBER	DESCRIPTION
SC Single Mode Pigtail - OS1 9/125µm	
TFT1C3S19S10	Pigtail SC Simplex OS1 SM 1.0m
TFT1C3S19S20	Pigtail SC Simplex OS1 SM 2.0m
SC Multi Mode Pigtail - OM1 62.5/125µm	
TFT1C3M16M10	Pigtail SC Simplex OM1 MM 1.0m
TFT1C3M16M20	Pigtail SC Simplex OM1 MM 2.0m
SC Multi Mode Pigtail - OM3 50/125µm	
TFT1C3M35M10	Pigtail SC Simplex OM3 MM 1.0m
TFT1C3M35M20	Pigtail SC Simplex OM3 MM 2.0m
ST Single Mode Pigtail - OS1 9/125µm	
TFT1T3S19S10	Pigtail ST Simplex OS1 SM 1.0m
TFT1T3S19S20	Pigtail ST Simplex OS1 SM 2.0m
ST Multi Mode Pigtail - OM1 62.5/125µm	
TFT1T3M16M10	Pigtail ST Simplex OM1 MM 1.0m
TFT1T3M16M20	Pigtail ST Simplex OM1 MM 2.0m
ST Multi Mode Pigtail - OM3 50/125µm	
TFT1T3M35M10	Pigtail ST Simplex OM3 MM 1.0m
TFT1T3M35M20	Pigtail ST Simplex OM3 MM 2.0m
LC Single Mode Pigtail - OS1 9/125µm	
TFT1L3S19S10	Pigtail LC Simplex OS1 SM 1.0M
TFT1L3S19S20	Pigtail LC Simplex OS1 SM 2.0M
LC Multi Mode Pigtail - OM1 62.5/125µm	
TFT1L3M16M10	Pigtail LC Simplex OM1 MM 1.0M
TFT1L3M16M20	Pigtail LC Simplex OM1 MM 2.0M
LC Multi Mode Pigtail - OM3 50/125µm	
TFT1L3M35M10	Pigtail LC Simplex OM3 MM 1.0M
TFT1L3M35M20	Pigtail LC Simplex OM3 MM 2.0M

PRODUCT FEATURES

- Available in several lengths.
- Factory terminated.
- Cords are easy to install and environmentally stable.
- AS/NZS 3080: 2003 standard compliant.
- Colour coded cable and adaptors for single mode applications.

CUSTOMER BENEFITS

- The various lengths allow for easier cable management.
- Compliant to local and international standards.

12 Core Fibre Pigtail - Rainbow

The Clipsal fibre optic pigtails are a superior product, delivering the best network performance when used in conjunction with other Clipsal Datacomms Fibre Optic products.

Clipsal offers a complete range of pigtails in a wide variety of configurations, all constructed with high quality materials.

The rainbow pigtails are specifically colour coded to match backbone fibre cabling and assist in fibre splicing.

As an integral part of the Clipsal Datacomms Fibre Optic Series, these products have a lifetime warranty and system performance guarantee when installed by a Clipsal Certified Installer or Endorsed Partner.

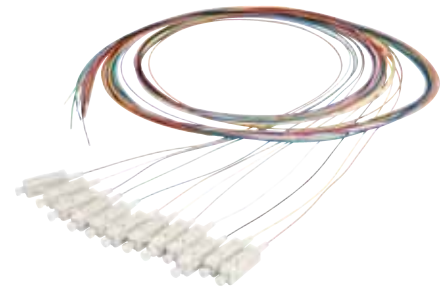

TFT12C3M16M10

PRODUCT FEATURES

- Available in several lengths.
- Factory terminated.
- Cords are easy to install and environmentally stable.
- AS/NZS 3080: 2003 standard compliant.
- Colour coded cable and adaptors for single mode applications.

CUSTOMER BENEFITS

- The various lengths allow for easier cable management.
- Compliant to local and international standards.

CATALOGUE NUMBER	DESCRIPTION
OS1 9/125µm Fibre - Single Mode	
TFT12C3S19S10	Pigtail SC 12 Core OS1 SM 1.0m
TFT12L3S19S10	Pigtail LC 12 Core OS1 SM 1.0m
OM1 62.5/125µm Fibre - Multi Mode	
TFT12C3M16M10	Pigtail SC Core OM1 MM 1.0m
TFT12L3M16M10	Pigtail LC Core OM1 MM 1.0m
OM3 50/125µm Fibre - Multi Mode	
TFT12C3M35M10	Pigtail SC Core OM3 MM 1.0m
TFT12L3M35M10	Pigtail LC Core OM3 MM 1.0m

Optical Fibre Cable Indoor/Outdoor Riser Single Mode - OS1 9/125am

The Clipsal indoor/outdoor riser optical cable features 900µm tight buffered optical fibres. The cable core is surrounded with high absorption performance, water-swellable yarns thus permitting rapid cable preparation and termination. The cable outer sheath is UV resistant and made from a Low Smoke Zero Halogen (LSZH) flame retardant and low toxicity gas emission material.



2F6SMIOLR

The riser cable is suitable for:

- Local Area Network
- Horizontal Wiring
- Building Backbone
- Campus Backbone.

Most suitable for riser application; e.g. lift shafts, as fibres will not creep within cable jacket. No looping is required. Vertical drops up to 100m can be achieved with no clamping. Longer distances can be achieved with clamping at least every 600mm.

Typical installation environment for these indoor/outdoor cables includes fully enclosed locations as well as external locations where cable may be soaked by water on an intermittent basis. When installed outdoors, cable must be installed in dry and drained conduit or duct. These must be effectively maintained throughout the life of the cable to ensure no water penetration, and adequate drainage should water penetration occur.

COLOUR CHART

Fibre Number	Colour
1	Blue
2	Orange
3	Green
4	Brown
5	Grey
6	White

Fibre Count	Diameter (mm)	Mass (kg/km)	Min. Bend Radius (mm)	Max. Tensile Strength (kN)
6	5.6	30	105	0.6

CATALOGUE NUMBER DESCRIPTION

2F6SMIOLR Light Duty Riser Indoor/Outdoor 6 Fibre

Optical Fibre Cable Indoor/Outdoor Riser Multi Mode - OM1 6.25/125am

The Clipsal indoor/outdoor riser optical cable features 900µm tight buffered optical fibres. The cable core is surrounded with high absorption performance water swellable yarns thus permitting rapid cable preparation and termination. The cable outer sheath is UV resistant and made from a Low Smoke Zero Halogen (LSZH) flame retardant and low toxicity gas emission material.



2F8MMIOLR

The riser cable is suitable for:

- Local Area Network
- Horizontal Wiring
- Building Backbone
- Campus Backbone.

Most suitable for riser application; e.g. lift shafts, as fibres will not creep within cable jacket. No looping is required. Vertical drops up to 100m can be achieved with no clamping. Longer distances can be achieved with clamping at least every 600mm.

Typical installation environment for these indoor/outdoor cables includes fully enclosed locations, as well as external locations, where cable may be soaked by water on an intermittent basis. When installed outdoors, cable must be installed in dry and drained conduit or duct. These must be effectively maintained throughout the life of the cable to ensure no water penetration, and adequate drainage should water penetration occur.

COLOUR CHART

Fibre Number	Colour	Fibre Number	Colour
1	Blue	13	Blue
2	Orange	14	Orange
3	Green	15	Green
4	Brown	16	Brown
5	Grey	17	Grey
6	White	18	White
7	Red	19	Red
8	Black	20	Black
9	Yellow	21	Yellow
10	Violet	22	Violet
11	Pink	23	Pink
12	Aqua	24	Aqua

Note: For 24 fibre cables, unit colour coding applies.

Fibre Count	Diameter (mm)	Mass (kg/km)	Min. Bend Radius (mm)	Max. Tensile Strength (kN)
4	4.8	22	85	0.6
6	5.6	30	105	0.6
8	6.0	34	110	0.6
12	6.7	40	125	0.6
24	9.2	70	180	1.0

CATALOGUE NUMBER	DESCRIPTION
2F4MMIOLR	Light Duty Riser Indoor/Outdoor 4 Fibre
2F6MMIOLR	Light Duty Riser Indoor/Outdoor 6 Fibre
2F8MMIOLR	Light Duty Riser Indoor/Outdoor 8 Fibre
2F12MMIOLR	Light Duty Riser Indoor/Outdoor 12 Fibre
2F24MMIOLR	Light Duty Riser Indoor/Outdoor 24 Fibre

Optical Fibre Cable Indoor/Outdoor Riser Multi Mode - OM3 50/125am

The Clipsal indoor/outdoor riser optical cable features 900µm tight buffered optical fibres. The cable core is surrounded with high absorption performance water-swellable yarns, thus permitting rapid cable preparation and termination. The cable outer sheath is UV resistant and made from a Low Smoke Zero Halogen (LSZH) flame retardant and low toxicity gas emission material.



2F4CMIOR50

The riser cable is suitable for:

- Local Area Network
- Horizontal Wiring
- Building Backbone
- Campus Backbone.

Most suitable for riser application; (e.g. lift shafts), as fibres will not creep within cable jacket. No looping is required. Vertical drops up to 100m can be achieved with no clamping. Longer distances can be achieved with clamping at least every 600mm.

Typical installation environment for these indoor/outdoor cables includes fully enclosed locations, as well as external locations, where cable may be soaked by water on an intermittent basis. When installed outdoors, cable must be installed in dry and drained conduit or duct. These must be effectively maintained throughout the life of the cable to ensure no water penetration, and adequate drainage should water penetration occur.

COLOUR CHART

Fibre Number	Colour	Fibre Number	Colour
1	Blue	13	Blue
2	Orange	14	Orange
3	Green	15	Green
4	Brown	16	Brown
5	Grey	17	Grey
6	White	18	White
7	Red	19	Red
8	Black	20	Black
9	Yellow	21	Yellow
10	Violet	22	Violet
11	Pink	23	Pink
12	Aqua	24	Aqua

Note: For 24 fibre cables, unit colour coding applies.

Fibre Count	Diameter (mm)	Mass (kg/km)	Min. Bend Radius (mm)	Max. Tensile Strength (kN)
4	4.8	22	85	0.6
6	5.6	30	105	0.6
8	6.0	34	110	0.6
12	6.7	40	125	0.6
24	9.2	70	180	1.0

CATALOGUE NUMBER	DESCRIPTION
2F4CMIOR50	Light Duty Riser Indoor/Outdoor OM3 4 Core
2F6CMIOR50	Light Duty Riser Indoor/Outdoor OM3 6 Core
2F8CMIOR50	Light Duty Riser Indoor/Outdoor OM3 8 Core
2F12CMIOR50	Light Duty Riser Indoor/Outdoor OM3 12 Core
2F24CMIOR50	Light Duty Riser Indoor/Outdoor OM3 24 Core

Optical Fibre Cable Indoor/Outdoor Breakout Multi Mode - OM1 62.5/125µm

The Clipsal indoor/outdoor breakout optical cable features 900µm tight buffered optical fibres. The cable core is surrounded with high absorption performance water-swellaable yarns thus permitting rapid cable preparation and termination. The cable outer sheath is UV resistant and made from a Low Smoke Zero Halogen (LSZH) flame retardant and low toxicity gas emission material.

The riser cable is suitable for:

- Local Area Network (including FDDI Cabling)
- Ethernet
- Token Ring.

Most suitable for heavy duty and horizontal riser application (e.g. lift shafts), as fibres will not creep within cable jacket. No looping is required. Vertical drops up to 500m can be achieved with no clamping. Longer distances can be achieved with clamping at least every 3m.

Typical installation environment for these indoor/outdoor cables includes fully enclosed locations, as well as external locations, where cable may be soaked by water on an intermittent basis. When installed outdoors, cable must be installed in dry and drained conduit or duct. These must be effectively maintained throughout the life of the cable to ensure no water penetration, and adequate drainage should water penetration occur.



2F12CM10HB

Fibre Count	Diameter (mm)	Mass (kg/km)	Min. Bend Radius (mm)	Max. Tensile Strength (kN)
4	8.2	63/70	180	0.6
6	8.2	63/70	180	0.6

CATALOGUE NUMBER	DESCRIPTION
2F4CM10HB	Heavy Duty Breakout Cable Indoor/Outdoor 4 Fibre
2F6CM10HB	Heavy Duty Breakout Cable Indoor/Outdoor 6 Fibre

Optical Fibre Cable Underground Multi-Mode Loose Tube Dry Core - OM1 62.5/125am

The Clipsal distribution underground optical cable contains acrylate coated optical fibres in water blocked loose tubes. Elements are stranded around a non-metallic central strength member. The cable core is made up of a combination of water blocked loose tubes (each containing up to 12 optical fibres) and solid fillers, to give the required fibre count. The cable core is surrounded with high absorption performance water-swellable yarns and wrapped with tape/binders as required, thus permitting rapid cable preparation and termination. The cable is sheathed with polyethylene and jacketed with an integrally bounded nylon jacket as a protective layer against termites and ants.



2F6CMOLDN

The cable is suitable for:

- Local Area Network
- Ethernet as Wide Area Network
- Aerial Lashed
- ATM
- Direct Burial
- Video on Demand
- Campus Backbone
- In Conduit
- SDH
- Broadcast TV
- Underground.

OPTICAL FIBRE COLOUR CHART (12F PER TUBE)

Fibre Number	Colour
1	Blue
2	Orange
3	Green
4	Brown
5	Grey
6	White
7	Red
8	Black
9	Yellow
10	Violet
11	Pink
12	Aqua

Note: For 24 fibre cables, unit colour coding applies.

TUBE COLOUR CHART

Fibre Number	Colour
1	Blue
2	Orange

Fibre Count	Diameter (mm)	Mass (kg/km)	Min. Bend Radius (mm)	Max. Tensile Strength (kN)
4	4.8	22	85	0.6
6	5.6	30	105	0.6
8	6.0	34	110	0.6
12	6.7	40	125	0.6
24	9.2	70	180	1.0

CATALOGUE NUMBER	DESCRIPTION
2F4CMOLDN	Underground Loose Tube Dry Core - 4 Core Multi Mode Nylon Jacket 62.5/125
2F6CMOLDN	Underground Loose Tube Dry Core - 6 Core Multi Mode Nylon Jacket 62.5/125
2F8CMOLDN	Underground Loose Tube Dry Core - 8 Core Multi Mode Nylon Jacket 62.5/125
2F12CMOLDN	Underground Loose Tube Dry Core - 12 Core Multi Mode Nylon Jacket 62.5/125
2F24CMOLDN	Underground Loose Tube Dry Core - 24 Core Multi Mode Nylon Jacket 62.5/125

Clipsal Optical Fibre Cable Underground Multi-Mode Loose Tube Dry Core - OM3 50/125am

The Clipsal distribution underground optical cable contains acrylate coated optical fibres in water blocked loose tubes. Elements are stranded around a non-metallic central strength member. The cable core is made up of a combination of water blocked loose tubes (each containing up to 12 optical fibres) and solid fillers, to give the required fibre count. The cable core is surrounded with high absorption performance water-swellaable yarns and wrapped with tape/binders as required, thus permitting rapid cable preparation and termination. The cable is sheathed with polyethylene and jacketed with an integrally bounded nylon jacket as a protective layer against termites and ants.

The cable is suitable for:

- Local Area Network
- Ethernet as Wide Area Network
- Aerial Lashed
- ATM
- Direct Burial
- Video on Demand
- Campus Backbone
- In Conduit
- SDH
- Broadcast TV
- Underground.



2F4CMOLPN50

OPTICAL FIBRE COLOUR CHART (12F PER TUBE)

Fibre Number	Colour
1	Blue
2	Orange
3	Green
4	Brown
5	Grey
6	White
7	Red
8	Black
9	Yellow
10	Violet
11	Pink
12	Aqua

TUBE COLOUR CHART

Fibre Number	Colour
1	Blue
2	Orange

Fibre Count	Diameter (mm)	Mass (kg/km)	Min. Bend Radius (mm)	Max. Tensile Strength (kN)
2	9.1	60 - 65	180	1.8

CATALOGUE NUMBER	DESCRIPTION
2F4CMOLPN50	Underground Loose Tube Dry Core - 4 Core Multi Mode Nylon Jacket 50/125
2F6CMOLPN50	Underground Loose Tube Dry Core - 6 Core Multi Mode Nylon Jacket 50/125
2F8CMOLPN50	Underground Loose Tube Dry Core - 8 Core Multi Mode Nylon Jacket 50/125
2F12CMOLPN50	Underground Loose Tube Dry Core - 12 Core Multi Mode Nylon Jacket 50/125

Clipsal Optical Fibre Cable Underground Single Mode Loose Tube Dry Core - OS1 9/125am

The Clipsal distribution underground optical cable contains acrylate coated optical fibres in water blocked loose tubes. Elements are stranded around a non-metallic central strength member. The cable core is made up of a combination of water blocked loose tubes (each containing up to 12 optical fibres) and solid fillers, to give the required fibre count. The cable core is surrounded with high absorption performance water-swellable yarns and wrapped with tape/binders as required, thus permitting rapid cable preparation and termination. The cable is sheathed with polyethylene and jacketed with an integrally bounded nylon jacket as a protective layer against termites and ants.



2F6CSOLDN

The cable is suitable for:

- Local Area Network
- Ethernet as Wide Area Network
- Aerial Lashed
- ATM
- Direct Burial
- Video on Demand
- Campus Backbone
- In Conduit
- SDH
- Broadcast TV
- Underground.

OPTICAL FIBRE COLOUR CHART (12F PER TUBE)

Fibre Number	Colour
1	Blue
2	Orange
3	Green
4	Brown
5	Grey
6	White
7	Red
8	Black
9	Yellow
10	Violet
11	Pink
12	Aqua

TUBE COLOUR CHART

Fibre Number	Colour
1	Blue
2	Orange
3	Green
4	Brown

Fibre Count	Diameter (mm)	Mass (kg/km)	Min. Bend Radius (mm)	Max. Tensile Strength (kN)
2 - 48	9.1	60 - 65	180	1.8

CATALOGUE NUMBER	DESCRIPTION
2F6CSOLDN	Underground Loose Tube Dry Core - 6 Core Single Mode Nylon Jacket 9/125
2F8CSOLDN	Underground Loose Tube Dry Core - 8 Core Single Mode Nylon Jacket 9/125
2F12CSOLDN	Underground Loose Tube Dry Core - 12 Core Single Mode Nylon Jacket 9/125
2F24CSOLDN	Underground Loose Tube Dry Core - 24 Core Single Mode Nylon Jacket 9/125

Optical Fibre Cable Underground Composite Fibre Dry Core - OM1 62.5/125am - OS1 9/125am

The Clipsal distribution underground optical cable contains acrylate coated optical fibres in water blocked loose tubes. Elements are stranded around a non-metallic central strength member. The cable core is made up of a combination of water blocked loose tubes (each containing up to 12 optical fibres) and solid fillers, to give the required fibre count. The cable core is surrounded with high absorption performance water-swellable yarns and wrapped with tape/binders as required, thus permitting rapid cable preparation and termination. The cable is sheathed with polyethylene and jacketed with an integrally bounded nylon jacket as a protective layer against termites and ants.

The cable is suitable for:

- Local Area Network
- Ethernet as Wide Area Network
- Aerial Lashed
- ATM
- Direct Burial
- Video on Demand
- Campus Backbone
- In Conduit
- SDH
- Broadcast TV
- Underground.

OPTICAL FIBRE COLOUR CHART (12F PER TUBE)

Fibre Number	Colour
1	Blue
2	Orange
3	Green
4	Brown
5	Grey
6	White
7	Red
8	Black
9	Yellow
10	Violet
11	Pink
12	Aqua

TUBE COLOUR CHART

Fibre Number	Colour
1	Blue
2	Orange

Fibre Count	Diameter (mm)	Mass (kg/km)	Min. Bend Radius (mm)	Max. Tensile Strength (kN)
2 - 72	9.1	60 -65	180	1.8

CATALOGUE NUMBER	DESCRIPTION
2F6S6MOLDN	Underground Loose Tube Dry Core - Standard Construction S/M 6 Core M/M 6 Core
2F6S12MOLDN	Underground Loose Tube Dry Core - Standard Construction S/M 6 Core M/M12 Core
2F12S12MOLDN	Underground Loose Tube Dry Core - Standard Construction S/M 12 Core M/M 12 Core

ACTIVE EQUIPMENT

Fibre Media Converters

Fibre Media Converters

Clipsal's two core fibre media converters are stand alone physical layer devices that convert between 10/100 Base-TX and 100 Base-FX segments of the same network. The converter is designed with a switch controller and memory buffer, providing smooth operation and data transfer between the two media layers.

The media converters convert copper UTP Ethernet data to optical fibre and present both the up and down stream data on to two cores of optical fibre. The auto-negotiation features permit the media converter to operate at 10 or 100Mbps. The conversion process conforms to IEEE802.3 and IEEE802.3u Standards. Data transmission is optimised by store-and-forward technology.

Link fault pass through capabilities are built in to the devices. Front mounted panel LEDs convey various conditions and status to easily diagnose cable or network faults. The maximum distance of data communication for 50/125µm multi mode is 2km and is also achievable through 62.5/125µm multi-mode fibre cable.

The LAN extender is one of the dominant applications of the media converter which has the ability to connect LAN segments located at a distance of up to 2km apart. Note that this type of setup transmits data at the maximum rate of 100Mbps across the fibre, greatly reducing the chance of packet collisions between the two LAN segments.



95CMCST/A



95CMCSC/A

TECHNICAL SPECIFICATIONS

Catalogue Number	95CMCST/A	95CMCSC/A
COPPER		
Standard	IEEE 802.3u	
Connector	RJ45	
Impedance	100 Ohm	
OPTICAL FIBRE		
Source	LED	
Wavelength	1300nm	
Output Power	-10dBm±2dBm (9/125µm fibre)	
Connector	SC or ST	
Detector	InGaAs PIN photodiode	
Sensitivity	-31dBm minimum	
Optical Budget	11dB minimum (62.5/125µm fibre) 6dB minimum (50/125µm fibre)	
Maximum Distances	50/125µ MM is 2km 62.5/125µ MM is 2km	
Power Supply	5V d.c., up to 500mA, inner pin is positive	
Dimensions	20mm (W) x 84mm (H) x 61mm (D)	
Weight	170g	
Operating Temperature Range	0°C to 42°C	
Storage Temperature Range	-20°C to 70°C	
Safety	EN 60950, CSA 22.2 #950	
Electromagnetic Emissions	FCC Part 15, Class A; EN 55022, Class A	

PRODUCT FEATURES

- Complies with IEEE802.3 and IEEE802.3u Standards.
- Cost effective copper to fibre conversion.
- Connects via an SC or an ST connector.
- Convenient UTP to fibre media conversion.
- Extends LAN up to 2km for multi-mode fibre.
- Intuitive LEDs presented to help diagnostics.
- Auto MDI/MDI-X on UTP port.
- 10/100Mbps auto negotiation.
- Far end fault and link fault pass through.
- Power pack included.
- Plug-and-play.

CATALOGUE NUMBER	DESCRIPTION
95CMCST/A	100Mbps ST to RJ45 Fast Ethernet
95CMCSC/A	100Mbps SC to RJ45 Fast Ethernet



19" SYSTEM ENCLOSURES AND ACCESSORIES

Clipsal titanium® Cabinets
Clipsal Complete Cabinets
Clipsal Complete Frames
Clipsal Restricted Cabinets
Clipsal Class 'C' Cabinets
Clipsal titanium® Wall Cabinets
Clipsal Wall Cabinets
Clipsal Hinged Wall Frames
19" Lab Racks
Cabinet Accessories

Clipsal Cabinets

Clipsal free standing enclosures offer much more than aesthetics and additional room for cable management. Developed from the ground up, they incorporate features designed to assist in the installation of cabling and equipment, as well as allow for ease of moves and changes for future maintenance and upgrades.

The Clipsal free standing and wall cabinets have received tributes for their innovative design, attention to detail and class leading features. These accolades include success with the Australian Design Awards, and with the Australian Electrical and Electronic Manufacturers Association (AEMA).

NO EXTERNAL FRAME:

The Clipsal cabinets utilise the vertical side rails for the major structural rigidity for the cabinet. With no external frame or corners, installers and end users have uninhibited access to all cabling and equipment.

DUAL REAR DOORS:

The cabinets feature two rear doors, reducing the overall footprint of the structure. This allows easy access when the enclosure is installed in confined spaces. The doors also feature top and bottom vents to assist with cooling.

SIDE PANELS:

Side panels are removable and come complete with top and bottom vents to assist with cooling.

19" MOUNTING RAILS:

Front and rear rails are full adjustable providing flexibility.

CABLE PLINTH:

The bottom cable plinth provides trouble-free access to the bottom of the cabinet for cable entry.

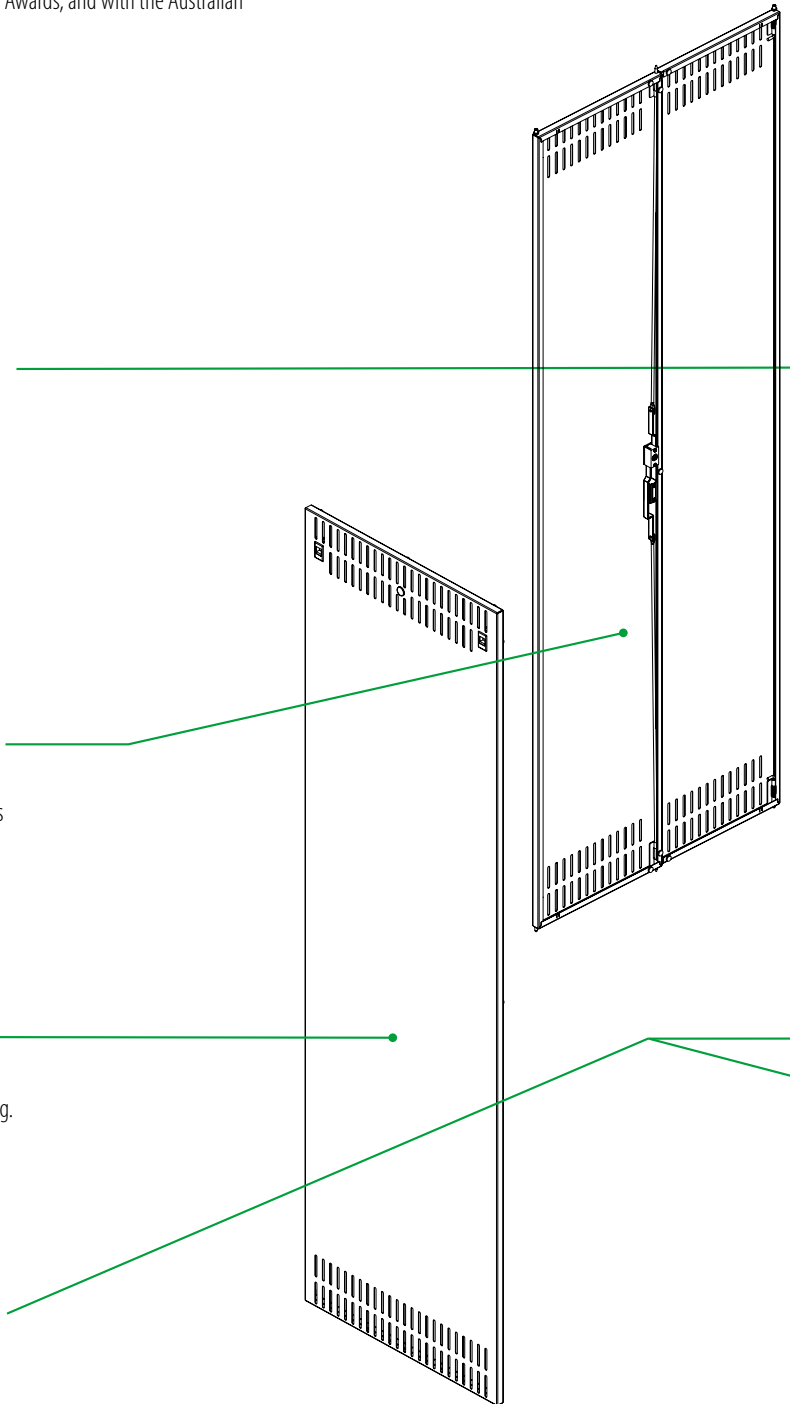

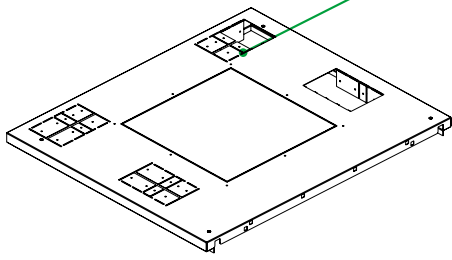

CEILING ACCESS:

Precision break-outs in the cabinet roof have been exclusively designed to suit Clipsal's range of "Maxi Duct" cable ducting.

DYNAMIC SIDE RAILS:

The side rails not only provide the structural strength for the cabinet, they can also be easily moved either forwards or backwards.

VENTILATION COWLINGS:

Top and bottom ventilation cowlings not only provide the enclosure with it's dramatic look, they also allow for cool air to be drawn into the front of the cabinet.

VERTICAL CABLE MANAGEMENT:

Another option available is the integrated vertical cable management, which utilises slotted "fingers" allowing users to select the desired position for the patch cords.

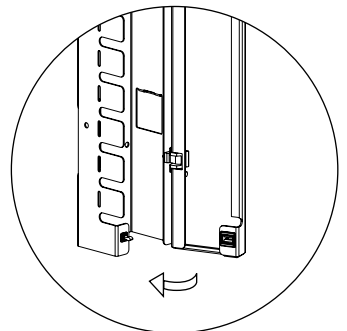

27RU Clipsal titanium® Cabinets 800mm x 800mm

The Clipsal titanium® cabinet range is available in 24" free standing enclosures. The steel rear door and sides are removable for easy access to racks, hubs and servers, while the shelf mounting rails can be accessed from the front and rear for more convenient installation and modification. Clipsal titanium® cabinets maintain Clipsal's policy of competitive advantage through innovation with products that set new standards for data communication systems enclosure design, functionality and aesthetics.

No compromise has been made on performance or practicality. The cabinet's steel frame construction is designed to cope with heavy equipment including servers, network bridges and routers all without buckling under the load.

DIMENSIONS

Catalogue Number	Height	Width	Depth
3106TC27C824	1492mm	800mm	800mm

CABLE ENTRIES

Top	4 of 50mm x 100mm break outs 1 of 360mm x 360mm break out
Bottom	Full access cable plinth

ACCESSORIES AVAILABLE

Catalogue Number	Description
3106FT260	2 Fan Tray
3106FT460	4 Fan Tray
3106CT27U15	27RU Cable Tray 150mm
3106CT27U22	27RU Cable Tray 225mm
3106THCM80	800mm Horizontal Cable Management
3106EK	Universal Earth Kit
3106PH6W2FP	Power Horizontal 6 Way 2M F&P
3106PH10W2FP	Power Horizontal 10 Way 2M F&P
3106PV10W2FP	Power Vertical 10 Way 2M F&P
3106PV10WJB	Power Vertical 10 Way Junction Box
3106CD55/100	Chimney
3106TH30	Thermostat 30° Suits all Fan Trays
3106TCJK	Joining Kit
3106SC (2U23 - 6U60)	Shelf Cantilever, 2RU
3106SF (1U41 - 1U61)	Shelf Fixed, 1RU
3106ST1U61	Shelf Telescopic 610mm Deep, 1RU

DOOR LOCK KEY NUMBER

92268



3106TC27C824

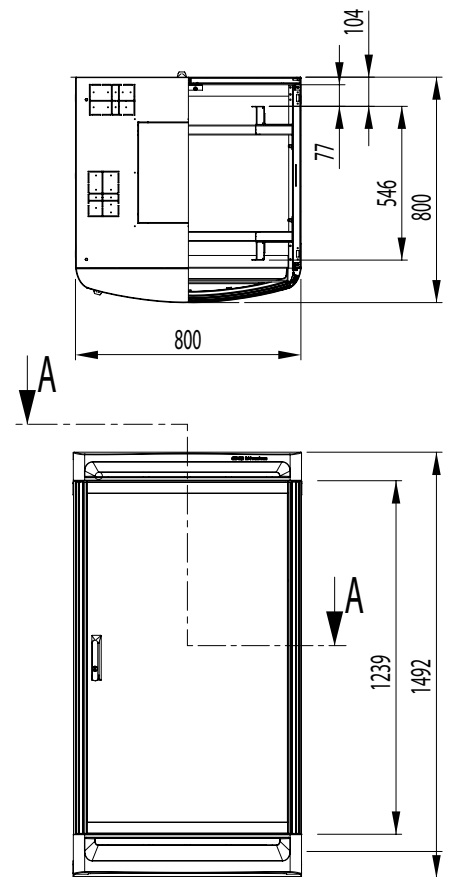

PRODUCT FEATURES

- Curved and tinted front acrylic door.
- No external frame – easy access to rails.
- Removable side and rear doors.
- Adjustable side rails (standard 19" width).

CATALOGUE NUMBER	DESCRIPTION
3106TC27C824	27RU Complete Clipsal titanium® Cabinet 800mm (W) x 800mm (D)

27RU Clipsal titanium® Cabinets 800mm x 900mm

The Clipsal titanium® cabinet range is available in 24" free standing enclosures. The steel rear door and sides are removable for easy access to racks, hubs and servers, while the shelf mounting rails can be accessed from the front and rear for more convenient installation and modification. Clipsal titanium® cabinets maintain Clipsal's policy of competitive advantage through innovation with products that set new standards for data communication systems enclosure design, functionality and aesthetics.

No compromise has been made on performance or practicality. The cabinet's steel frame construction is designed to cope with heavy equipment including servers, network bridges and routers all without buckling under the load.

DIMENSIONS

Catalogue Number	Height	Width	Depth
3106TC27C924	1492mm	800mm	900mm

CABLE ENTRIES

Top	4 of 50mm x 100mm break outs 1 of 360mm x 360mm break out
Bottom	Full access cable plinth

ACCESSORIES AVAILABLE

Catalogue Number	Description
3106FT260	2 Fan Tray
3106FT460	4 Fan Tray
3106CT27U15	27RU Cable Tray 150mm
3106CT27U22	27RU Cable Tray 225mm
3106THCM90	900mm Horizontal Cable Tray
3106EK	Universal Earth Kit
3106PH6W2FP	Power Horizontal 6 Way 2M F&P
3106PH10W2FP	Power Horizontal 10 Way 2M F&P
3106PV10W2FP	Power Vertical 10 Way 2M F&P
3106PV10WJB	Power Vertical 10 Way Junction Box
3106TCD55/100	Chimney
3106TH30	Thermostat 30° Suits all fan trays
3106TCJK	Joining Kit
3106SC (2U23 - 6U60)	Shelf Cantilever, 2RU
3106SF (1U41 - 1U71)	Shelf Fixed, 1RU
3106ST2U71HD	Shelf Telescopic 710mm Deep, Heavy Duty, 2RU

DOOR LOCK KEY NUMBER

92268



3106TC27C924

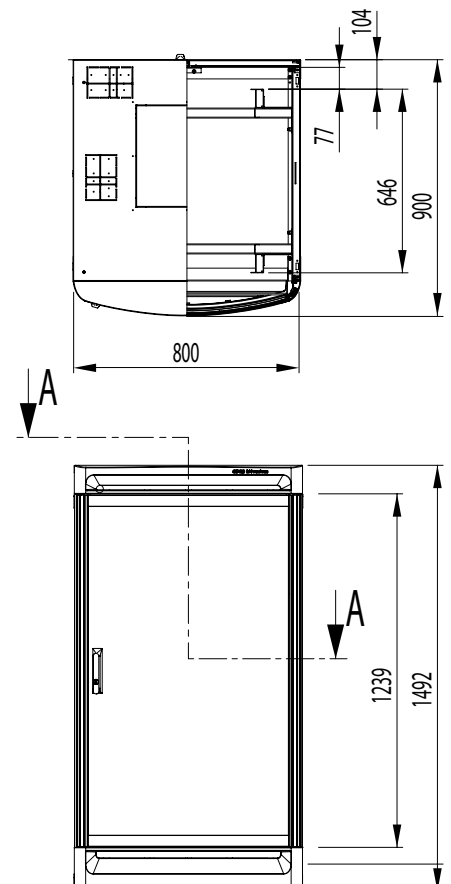

PRODUCT FEATURES

- Curved and tinted front acrylic door.
- No external frame – easy access to rails.
- Removable side and rear doors.
- Adjustable side rails (standard 19" width).

CATALOGUE NUMBER	DESCRIPTION
3106TC27C924	27RU Complete Clipsal titanium® Cabinet 800mm (W) x 900mm (D)

27RU Clipsal titanium[®] Cabinets 800mm x 1000mm

The Clipsal titanium[®] cabinet range is available in 24" free standing enclosures. The steel rear door and sides are removable for easy access to racks, hubs and servers, while the shelf mounting rails can be accessed from the front and rear for more convenient installation and modification. Clipsal titanium[®] cabinets maintain Clipsal's policy of competitive advantage through innovation with products that set new standards for data communication systems enclosure design, functionality and aesthetics.

No compromise has been made on performance or practicality. The cabinet's steel frame construction is designed to cope with heavy equipment including servers, network bridges and routers all without buckling under the load.

DIMENSIONS

Catalogue Number	Height	Width	Depth
3106TC27C1024	1492mm	800mm	1000mm

CABLE ENTRIES

Top	4 of 50mm x 100mm break outs 2 of 360mm x 360mm break outs
Bottom	Full access cable plinth

ACCESSORIES AVAILABLE

Catalogue Number	Description
3106FT260	2 Fan Tray
3106FT460	4 Fan Tray
3106CT27U15	27RU Cable Tray 150mm
3106CT27U22	27RU Cable Tray 225mm
3106THCM100	1000mm Horizontal Cable Tray
3106EK	Universal Earth Kit
3106PH6W2FP	Power Horizontal 6 Way 2M F&P
3106PH10W2FP	Power Horizontal 10 Way 2M F&P
3106PV10W2FP	Power Vertical 10 Way 2M F&P
3106PV10WJB	Power Vertical 10 Way Junction Box
3106TCD55/100	Chimney
3106TH30	Thermostat 30° Suits all Fan Trays
3106TCJK	Joining Kit
3106SC (2U23 - 6U60)	Shelf Cantilever, 2RU
3106SF (1U41 - 1U81)	Shelf Fixed, 1RU
3106ST2U71HD	Shelf Telescopic 710mm Deep, Heavy Duty, 2RU

DOOR LOCK KEY NUMBER

92268



3106TC27C1024

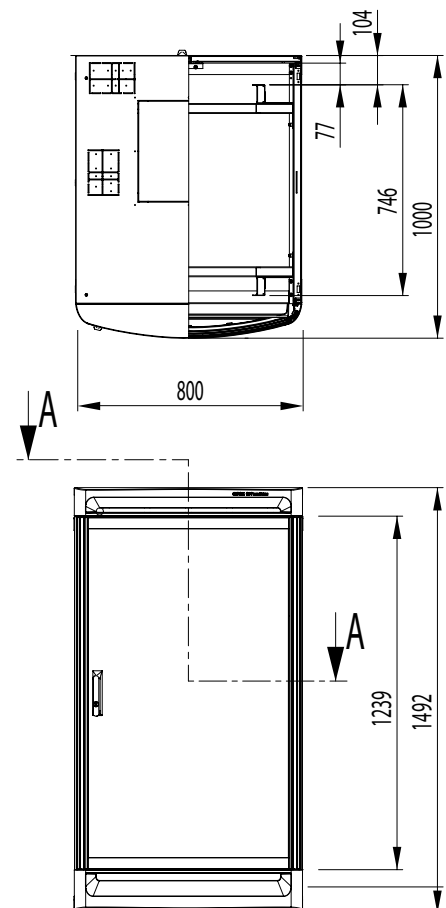

PRODUCT FEATURES

- Curved and tinted front acrylic door.
- No external frame – easy access to rails.
- Removable side and rear doors.
- Adjustable side rails (standard 19" width).

CATALOGUE NUMBER	DESCRIPTION
3106TC27C1024	27RU Complete Clipsal titanium [®] Cabinet 800mm (W) x 1000mm (D)

27RU Clipsal titanium[®] Cabinets 800mm x 1200mm

The Clipsal titanium[®] cabinet range is available in 24" free standing enclosures. The steel rear door and sides are removable for easy access to racks, hubs and servers, while the shelf mounting rails can be accessed from the front and rear for more convenient installation and modification. Clipsal titanium[®] cabinets maintain Clipsal's policy of competitive advantage through innovation with products that set new standards for data communication systems enclosure design, functionality and aesthetics.

No compromise has been made on performance or practicality. The cabinet's steel frame construction is designed to cope with heavy equipment including servers, network bridges and routers all without buckling under the load.

DIMENSIONS

Catalogue Number	Height	Width	Depth
3106TC27C1224	1492mm	800mm	1200mm

CABLE ENTRIES

Top	4 of 50mm x 100mm break outs 2 of 360mm x 360mm break outs
Bottom	Full access cable plinth

ACCESSORIES AVAILABLE

Catalogue Number	Description
3106FT260	2 Fan Tray
3106FT460	4 Fan Tray
3106CT27U15	27RU Cable Tray 150mm
3106CT27U22	27RU Cable Tray 225mm
3106THCM120	1200mm Horizontal Cable Tray
3106EK	Universal Earth Kit
3106PH6W2FP	Power Horizontal 6 Way 2M F&P
3106PH10W2FP	Power Horizontal 10 Way 2M F&P
3106PV10W2FP	Power Vertical 10 Way 2M F&P
3106PV10WJB	Power Vertical 10 Way Junction Box
3106TCD55/100	Chimney
3106TH30	Thermostat 30° Suits all fan trays
3106TCJK	Joining Kit
3106SC (2U23 - 6U60)	Shelf Cantilever, 2RU
3106SF (1U41 - 1U101)	Shelf Fixed, 1RU
3106ST2U71HD	Shelf Telescopic 710mm Deep, Heavy Duty, 2RU

DOOR LOCK KEY NUMBER

92268



3106TC27C1224

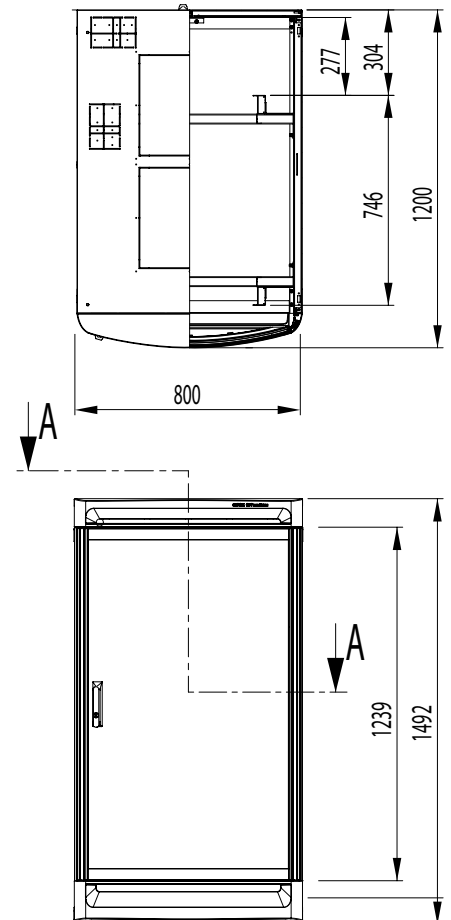

PRODUCT FEATURES

- Curved and tinted front acrylic door.
- No external frame – easy access to rails.
- Removable side and rear doors.
- Adjustable side rails (standard 19" width).

CATALOGUE NUMBER	DESCRIPTION
3106TC27C1224	27RU Complete Clipsal titanium [®] Cabinet 800mm (W) x 1200mm (D)

39RU Clipsal titanium® Cabinets 800mm x 800mm

The Clipsal titanium® cabinet range is available in 24" free standing enclosures. The steel rear door and sides are removable for easy access to racks, hubs and servers, while the shelf mounting rails can be accessed from the front and rear for more convenient installation and modification. Clipsal titanium® cabinets maintain Clipsal's policy of competitive advantage through innovation with products that set new standards for data communication systems enclosure design, functionality and aesthetics.

No compromise has been made on performance or practicality. The cabinet's steel frame construction is designed to cope with heavy equipment including servers, network bridges and routers all without buckling under the load.

DIMENSIONS

Catalogue Number	Height	Width	Depth
3106TC39C824	2025mm	800mm	800mm

CABLE ENTRIES

Top	4 of 50mm x 100mm break outs 1 of 360mm x 360mm break out
Bottom	Full access cable plinth

ACCESSORIES AVAILABLE

Catalogue Number	Description
3106FT260	2 Fan Tray
3106FT460	4 Fan Tray
3106CT39U15	39RU Cable Tray 150mm
3106CT39U22	39RU Cable Tray 225mm
3106CT39U30	39RU Cable Tray 300mm
3106THCM80	800mm Horizontal Cable Tray
3106EK	Universal Earth Kit
3106TVCM39	Vertical Cable Mgt 39RU (1 side)
3106PH6W2FP	Power Horizontal 6 Way 2M F&P
3106PH10W2FP	Power Horizontal 10 Way 2M F&P
3106PV10W2FP	Power Vertical 10 Way 2M F&P
3106PV10WJB	Power Vertical 10 Way Junction Box
3106PV13W2FP	Power Vertical 13 Way 2M F&P
3106TCD55/100	Chimney
3106TH30	Thermostat 30° Suits all Fan Trays
3106TCJK	Joining Kit
3106SC (2U23 - 6U60)	Shelf Cantilever, 2RU
3106SF (1U41 - 1U61)	Shelf Fixed, 1RU
3106ST1U61	Shelf Telescopic 610mm Deep, 1RU

DOOR LOCK KEY NUMBER

92268



3106TC39C824

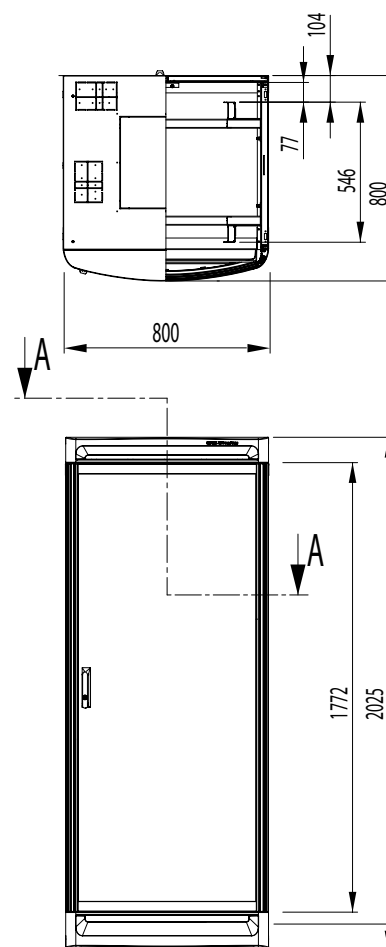

PRODUCT FEATURES

- Curved and tinted front acrylic door.
- No external frame – easy access to rails.
- Removable side and rear doors.
- Adjustable side rails (standard 19" width).

CATALOGUE NUMBER	DESCRIPTION
3106TC39C824	39RU Complete Clipsal titanium® Cabinet 800mm (W) x 800mm (D)

39RU Clipsal titanium® Cabinets 800mm x 900mm

The Clipsal titanium® cabinet range is available in 24" free standing enclosures. The steel rear door and sides are removable for easy access to racks, hubs and servers, while the shelf mounting rails can be accessed from the front and rear for more convenient installation and modification. Clipsal titanium® cabinets maintain Clipsal's policy of competitive advantage through innovation with products that set new standards for data communication systems enclosure design, functionality and aesthetics.

No compromise has been made on performance or practicality. The cabinet's steel frame construction is designed to cope with heavy equipment including servers, network bridges and routers all without buckling under the load.

DIMENSIONS

Catalogue Number	Height	Width	Depth
3106TC39C924	2025mm	800mm	900mm

CABLE ENTRIES

Top	4 of 50mm x 100mm break outs 1 of 360mm x 360mm break out
Bottom	Full access cable plinth

ACCESSORIES AVAILABLE

Catalogue Number	Description
3106FT260	2 Fan Tray
3106FT460	4 Fan Tray
3106CT39U15	39RU Cable Tray 150mm
3106CT39U22	39RU Cable Tray 225mm
3106CT39U30	39RU Cable Tray 300mm
3106THCM90	900mm Horizontal Cable Tray
3106EK	Universal Earth Kit
3106TVCM39	Vertical Cable Mgt 39RU (1 side)
3106PH6W2FP	Power Horizontal 6 Way 2M F&P
3106PH10W2FP	Power Horizontal 10 Way 2M F&P
3106PV10W2FP	Power Vertical 10 Way 2M F&P
3106PV13W2FP	Power Vertical 13 Way 2M F&P
3106PV10WJB	Power Vertical 10 Way Junction Box
3106PV20WJB	Power Vertical 20 Way Junction Box
3106TCD55/100	Chimney
3106TH30	Thermostat 30° Suits all Fan Trays
3106TCJK	Joining Kit
3106SC (2U23 - 6U60)	Shelf Cantilever, 2RU
3106SF (1U41 - 1U61)	Shelf Fixed, 1RU
3106ST2U71HD	Shelf Telescopic 710mm Deep, Heavy Duty, 2RU

DOOR LOCK KEY NUMBER

92268



3106TC39C924

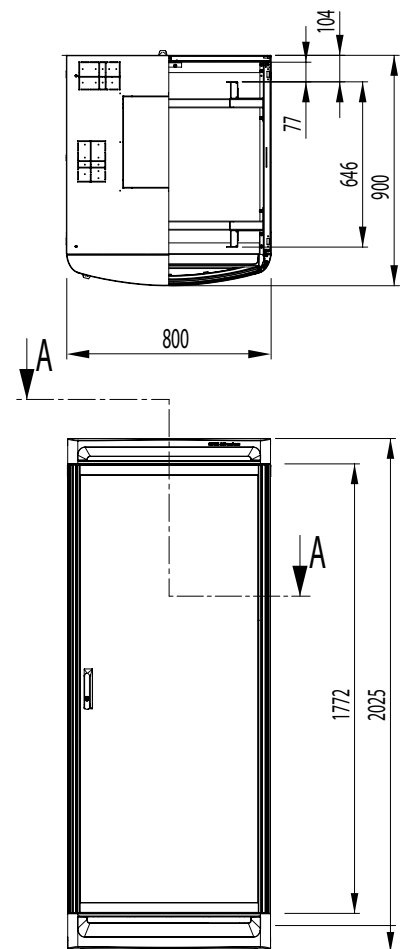

PRODUCT FEATURES

- Curved and tinted front acrylic door.
- No external frame – easy access to rails.
- Removable side and rear doors.
- Adjustable side rails (standard 19" width).

CATALOGUE NUMBER	DESCRIPTION
3106TC39C924	39RU Complete Clipsal titanium® Cabinet 800mm (W) x 900mm (D)

39RU Clipsal titanium® Cabinets 800mm x 1000mm

The Clipsal titanium® cabinet range is available in 24" free standing enclosures. The steel rear door and sides are removable for easy access to racks, hubs and servers, while the shelf mounting rails can be accessed from the front and rear for more convenient installation and modification. Clipsal titanium® cabinets maintain Clipsal's policy of competitive advantage through innovation with products that set new standards for data communication systems enclosure design, functionality and aesthetics.

No compromise has been made on performance or practicality. The cabinet's steel frame construction is designed to cope with heavy equipment including servers, network bridges and routers all without buckling under the load.

DIMENSIONS

Catalogue Number	Height	Width	Depth
3106TC39C1024	2025mm	800mm	1000mm

CABLE ENTRIES

Top	4 of 50mm x 100mm break outs 1 of 360mm x 360mm break out
Bottom	Full access cable plinth

ACCESSORIES AVAILABLE

Catalogue Number	Description
3106FT260	2 Fan Tray
3106FT460	4 Fan Tray
3106CT39U15	39RU Cable Tray 150mm
3106CT39U22	39RU Cable Tray 225mm
3106CT39U30	39RU Cable Tray 300mm
3106THCM100	1000mm Horizontal Cable Tray
3106EK	Universal Earth Kit
3106TVCM39	Vertical Cable Mgt 39RU (1 side)
3106PH6W2FP	Power Horizontal 6 Way 2M F&P
3106PH10W2FP	Power Horizontal 10 Way 2M F&P
3106PV10W2FP	Power Vertical 10 Way 2M F&P
3106PV13W2FP	Power Vertical 13 Way 2M F&P
3106PV10WJB	Power Vertical 10 Way Junction Box
3106PV20WJB	Power Vertical 20 Way Junction Box
3106TCD55/100	Chimney
3106TH30	Thermostat 30° Suits all Fan Trays
3106TCJK	Joining Kit
3106SC (2U23 - 6U60)	Shelf Cantilever, 2RU
3106SF (1U41 - 1U81)	Shelf Fixed, 1RU
3106ST2U71HD	Shelf Telescopic 710mm Deep, Heavy Duty, 2RU

DOOR LOCK KEY NUMBER

92268



3106TC39C1024

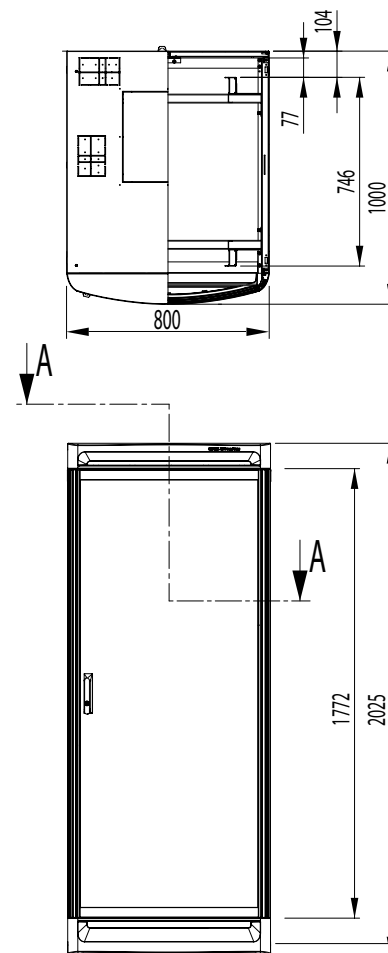

PRODUCT FEATURES

- Curved and tinted front acrylic door.
- No external frame – easy access to rails.
- Removable side and rear doors.
- Adjustable side rails (standard 19" width).

CATALOGUE NUMBER	DESCRIPTION
3106TC39C1024	39RU Complete Clipsal titanium® Cabinet 800mm (W) x 1000mm (D)

39RU Clipsal titanium® Cabinets 800mm x 1200mm

The Clipsal titanium® cabinet range is available in 24" free standing enclosures. The steel rear door and sides are removable for easy access to racks, hubs and servers, while the shelf mounting rails can be accessed from the front and rear for more convenient installation and modification. Clipsal titanium® cabinets maintain Clipsal's policy of competitive advantage through innovation with products that set new standards for data communication systems enclosure design, functionality and aesthetics.

No compromise has been made on performance or practicality. The cabinet's steel frame construction is designed to cope with heavy equipment including servers, network bridges and routers all without buckling under the load.

DIMENSIONS

Catalogue Number	Height	Width	Depth
3106TC39C1224	2025mm	800mm	1200mm

CABLE ENTRIES

Top	<p>4 of 50mm x 100mm break outs 2 of 360mm x 360mm break outs</p>
Bottom	<p>Full access cable plinth</p>

ACCESSORIES AVAILABLE

Catalogue Number	Description
3106FT260	2 Fan Tray
3106FT460	4 Fan Tray
3106CT39U15	39RU Cable Tray 150mm
3106CT39U22	39RU Cable Tray 225mm
3106CT39U30	39RU Cable Tray 300mm
3106EK	Universal Earth Kit
3106TVMC39	Vertical Cable Mgt 39RU (1 side)
3106PH6W2FP	Power Horizontal 6 Way 2M F&P
3106PH10W2FP	Power Horizontal 10 Way 2M F&P
3106PV10W2FP	Power Vertical 10 Way 2M F&P
3106PV13W2FP	Power Vertical 13 Way 2M F&P
3106PV10WJB	Power Vertical 10 Way Junction Box
3106PV20WJB	Power Vertical 20 Way Junction Box
3106TCD55/100	Chimney
3106TH30	Thermostat 30° Suits all Fan Trays
3106TCJK	Joining Kit
3106SC (2U23 - 6U60)	Shelf Cantilever, 2RU
3106SF (1U41 - 1U71)	Shelf Fixed, 1RU
3106ST2U71HD	Shelf Telescopic 710mm Deep, Heavy Duty, 2RU

DOOR LOCK KEY NUMBER

92268



3106TC39C1224

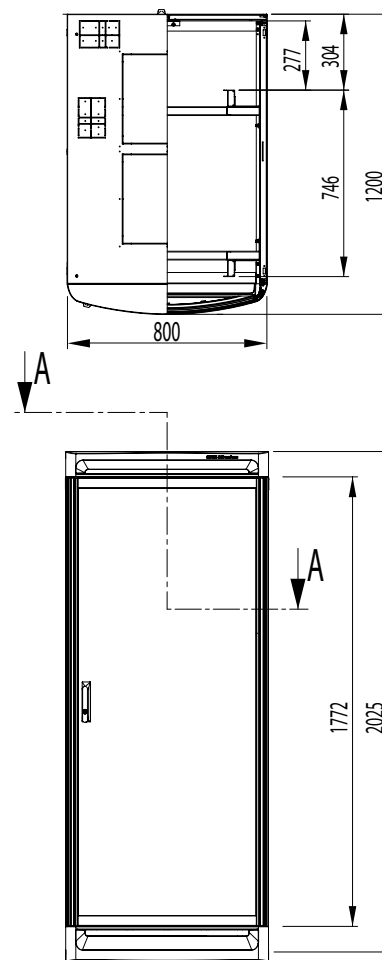

PRODUCT FEATURES

- Curved and tinted front acrylic door.
- No external frame – easy access to rails.
- Removable side and rear doors.
- Adjustable side rails (standard 19" width).

CATALOGUE NUMBER	DESCRIPTION
3106TC39C1224	39RU Complete Clipsal titanium® Cabinet 800mm (W) x 1200mm (D)

45RU Clipsal titanium® Cabinets 800mm x 800mm

The Clipsal titanium® cabinet range is available in 24" free standing enclosures. The steel rear door and sides are removable for easy access to racks, hubs and servers, while the shelf mounting rails can be accessed from the front and rear for more convenient installation and modification. Clipsal titanium® cabinets maintain Clipsal's policy of competitive advantage through innovation with products that set new standards for data communication systems enclosure design, functionality and aesthetics.

No compromise has been made on performance or practicality. The cabinet's steel frame construction is designed to cope with heavy equipment including servers, network bridges and routers all without buckling under the load.

DIMENSIONS

Catalogue Number	Height	Width	Depth
3106TC45C824	2292mm	800mm	800mm

CABLE ENTRIES

Top	4 of 50mm x 100mm break outs 1 of 360mm x 360mm break out
Bottom	Full access cable plinth

ACCESSORIES AVAILABLE

Catalogue Number	Description
3106FT260	2 Fan Tray
3106FT460	4 Fan Tray
3106CT45U15	45RU Cable Tray 150mm
3106CT45U22	45RU Cable Tray 225mm
3106CT45U30	45RU Cable Tray 300mm
3106THCM80	800mm Horizontal Cable Tray
3106EK	Universal Earth Kit
3106TVC45	Vertical Cable Mgt 45RU (1 side)
3106PH6W2FP	Power Horizontal 6 Way 2M F&P
3106PH10W2FP	Power Horizontal 10 Way 2M F&P
3106PV10W2FP	Power Vertical 10 Way 2M F&P
3106PV16W2FP	Power Vertical 16 Way 2M F&P
3106PV20W2FP	Power Vertical 20 Way 2M F&P
3106PV10WJB	Power Vertical 10 Way Junction Box
3106PV16WJB	Power Vertical 16 Way Junction Box
3106PV20WJB	Power Vertical 20 Way Junction Box
3106TCD55/100	Chimney
3106TH30	Thermostat 30° Suits all Fan Trays
3106TCJK	Joining Kit
3106SC (2U23 - 6U60)	Shelf Cantilever, 2RU
3106SF (1U41 - 1U61)	Shelf Fixed, 1RU
3106ST1U61	Shelf Telescopic 610mm Deep, 1RU

DOOR LOCK KEY NUMBER

92268



3106TC45C824

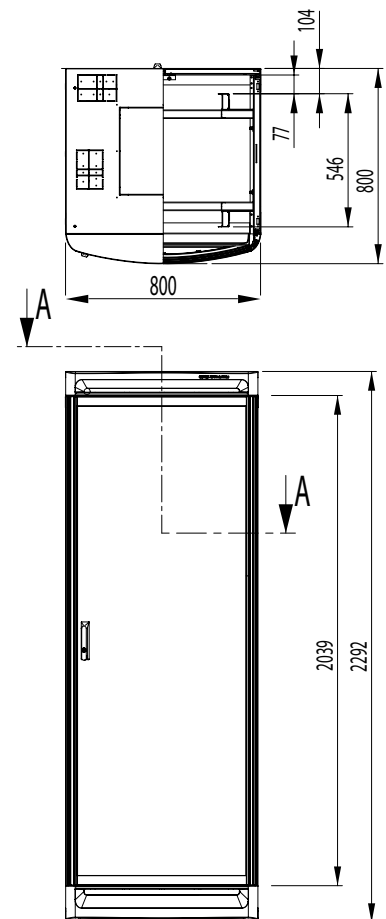

PRODUCT FEATURES

- Curved and tinted front acrylic door.
- No external frame – easy access to rails.
- Removable side and rear doors.
- Adjustable side rails (standard 19" width).

CATALOGUE NUMBER	DESCRIPTION
3106TC45C824	45RU Complete Clipsal titanium® Cabinet 800mm (W) x 800mm (D)

45RU Clipsal titanium® Cabinets 800mm x 900mm

The Clipsal titanium® cabinet range is available in 24" free standing enclosures. The steel rear door and sides are removable for easy access to racks, hubs and servers, while the shelf mounting rails can be accessed from the front and rear for more convenient installation and modification. Clipsal titanium® cabinets maintain Clipsal's policy of competitive advantage through innovation with products that set new standards for data communication systems enclosure design, functionality and aesthetics.

No compromise has been made on performance or practicality. The cabinet's steel frame construction is designed to cope with heavy equipment including servers, network bridges and routers all without buckling under the load.

DIMENSIONS

Catalogue Number	Height	Width	Depth
3106TC45C924	2292mm	800mm	900mm

CABLE ENTRIES

Top	4 of 50mm x 100mm break outs 1 of 360mm x 360mm break out
Bottom	Full access cable plinth

ACCESSORIES AVAILABLE

Catalogue Number	Description
3106FT260	2 Fan Tray
3106FT460	4 Fan Tray
3106CT45U15	45RU Cable Tray 150mm
3106CT45U22	45RU Cable Tray 225mm
3106CT45U30	45RU Cable Tray 300mm
3106THCM90	900mm Horizontal Cable Tray
3106EK	Universal Earth Kit
3106TVC45	Vertical Cable Mgt 45RU (1 side)
3106PH6W2FP	Power Horizontal 6 Way 2M F&P
3106PH10W2FP	Power Horizontal 10 Way 2M F&P
3106PV10W2FP	Power Vertical 10 Way 2M F&P
3106PV16W2FP	Power Vertical 16 Way 2M F&P
3106PV20W2FP	Power Vertical 20 Way 2M F&P
3106PV10WJB	Power Vertical 10 Way Junction Box
3106PV16WJB	Power Vertical 16 Way Junction Box
3106PV20WJB	Power Vertical 20 Way Junction Box
3106TCD55/100	Chimney
3106TH30	Thermostat 30° Suits all Fan Trays
3106TCJK	Joining Kit
3106SC (2U23 - 6U60)	Shelf Cantilever, 2RU
3106SF (1U41 - 1U71)	Shelf Fixed, 1RU
3106ST2U71HD	Shelf Telescopic 710mm Deep, Heavy Duty, 2RU

DOOR LOCK KEY NUMBER

92268



3106TC45C924

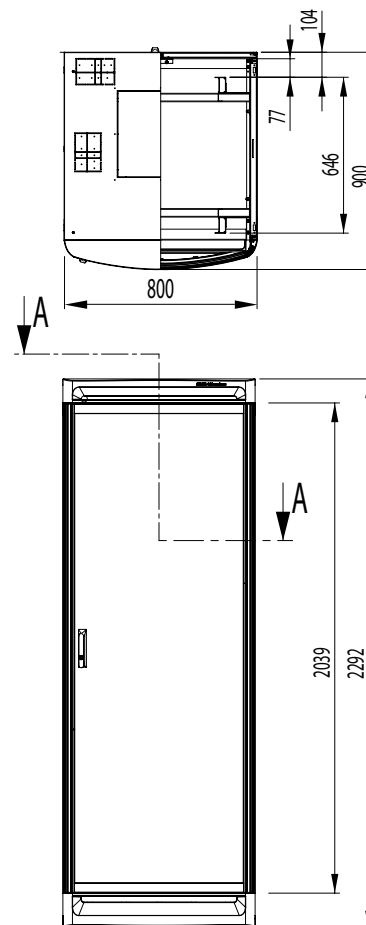

PRODUCT FEATURES

- Curved and tinted front acrylic door.
- No external frame – easy access to rails.
- Removable side and rear doors.
- Adjustable side rails (standard 19" width).

CATALOGUE NUMBER	DESCRIPTION
3106TC45C924	45RU Complete Clipsal titanium® Cabinet 800mm (W) x 900mm (D)

45RU Clipsal titanium® Cabinets 800mm x 1000mm

The Clipsal titanium® cabinet range is available in 24" free standing enclosures. The steel rear door and sides are removable for easy access to racks, hubs and servers, while the shelf mounting rails can be accessed from the front and rear for more convenient installation and modification. Clipsal titanium® cabinets maintain Clipsal's policy of competitive advantage through innovation with products that set new standards for data communication systems enclosure design, functionality and aesthetics.

No compromise has been made on performance or practicality. The cabinet's steel frame construction is designed to cope with heavy equipment including servers, network bridges and routers all without buckling under the load.

DIMENSIONS

Catalogue Number	Height	Width	Depth
3106TC45C1024	2292mm	800mm	1000mm

CABLE ENTRIES

Top	4 of 50mm x 100mm break outs 1 of 360mm x 360mm break out
Bottom	Full access cable plinth

ACCESSORIES AVAILABLE

Catalogue Number	Description
3106FT260	2 Fan Tray
3106FT460	4 Fan Tray
3106CT45U15	45RU Cable Tray 150mm
3106CT45U22	45RU Cable Tray 225mm
3106CT45U30	45RU Cable Tray 300mm
3106THCM100	1000mm Horizontal Cable Tray
3106EK	Universal Earth Kit
3106TVM45	Vertical Cable Mgt 45RU (1 side)
3106PH6W2FP	Power Horizontal 6 Way 2M F&P
3106PH10W2FP	Power Horizontal 10 Way 2M F&P
3106PV10W2FP	Power Vertical 10 Way 2M F&P
3106PV16W2FP	Power Vertical 16 Way 2M F&P
3106PV20W2FP	Power Vertical 20 Way 2M F&P
3106PV10WJB	Power Vertical 10 Way Junction Box
3106PV16WJB	Power Vertical 16 Way Junction Box
3106PV20WJB	Power Vertical 20 Way Junction Box
3106TCD55/100	Chimney
3106TH30	Thermostat 30° Suits all Fan Trays
3106TCJK	Joining Kit
3106SC (2U23 - 6U60)	Shelf Cantilever, 2RU
3106SF (1U41 - 1U81)	Shelf Fixed, 1RU
3106ST2U71HD	Shelf Telescopic 710mm Deep, Heavy Duty, 2RU



3106TC45C1024

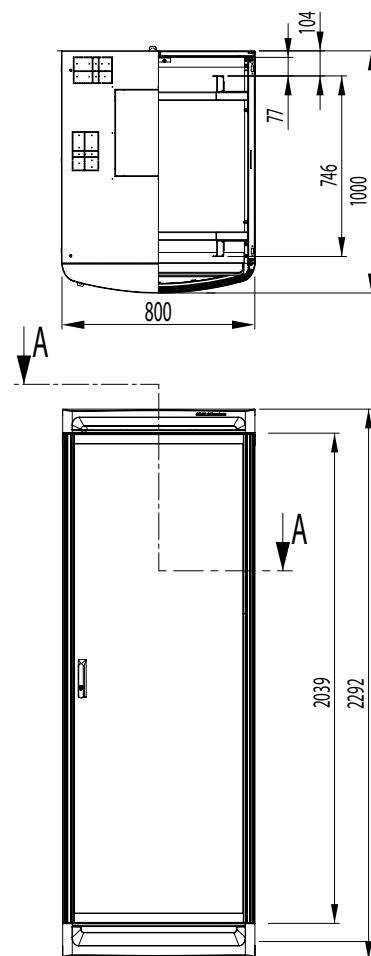

PRODUCT FEATURES

- Curved and tinted front acrylic door.
- No external frame – easy access to rails.
- Removable side and rear doors.
- Adjustable side rails (standard 19" width).

DOOR LOCK KEY NUMBER

92268

CATALOGUE NUMBER	DESCRIPTION
3106TC45C1024	45RU Complete Clipsal titanium® Cabinet 800mm (W) x 1000mm (D)

45RU Clipsal titanium® Cabinets 800mm x 1200mm

The Clipsal titanium® cabinet range is available in 24" free standing enclosures. The steel rear door and sides are removable for easy access to racks, hubs and servers, while the shelf mounting rails can be accessed from the front and rear for more convenient installation and modification. Clipsal titanium® cabinets maintain Clipsal's policy of competitive advantage through innovation with products that set new standards for data communication systems enclosure design, functionality and aesthetics.

No compromise has been made on performance or practicality. The cabinet's steel frame construction is designed to cope with heavy equipment including servers, network bridges and routers all without buckling under the load.

DIMENSIONS

Catalogue Number	Height	Width	Depth
3106TC45C1224	2292mm	800mm	1200mm

CABLE ENTRIES

Top	4 of 50mm x 100mm break outs 1 of 360mm x 360mm break out
Bottom	Full access cable plinth

ACCESSORIES AVAILABLE

Catalogue Number	Description
3106FT260	2 Fan Tray
3106FT460	4 Fan Tray
3106CT45U15	45RU Cable Tray 150mm
3106CT45U22	45RU Cable Tray 225mm
3106CT45U30	45RU Cable Tray 300mm
3106EK	Universal Earth Kit
3106TVC45	Vertical Cable Mgt 45RU (1 side)
3106PH6W2FP	Power Horizontal 6 Way 2M F&P
3106PH10W2FP	Power Horizontal 10 Way 2M F&P
3106PV10W2FP	Power Vertical 10 Way 2M F&P
3106PV16W2FP	Power Vertical 16 Way 2M F&P
3106PV20W2FP	Power Vertical 20 Way 2M F&P
3106PV10WJB	Power Vertical 10 Way Junction Box
3106PV16WJB	Power Vertical 16 Way Junction Box
3106PV20WJB	Power Vertical 20 Way Junction Box
3106TCD55/100	Chimney
3106TH30	Thermostat 30° Suits all Fan Trays
3106TCJK	Joining Kit
3106SC (2U23 - 6U60)	Shelf Cantilever, 2RU
3106SF (1U41 - 1U101)	Shelf Fixed, 1RU
3106ST2U71HD	Shelf Telescopic 610mm Deep, Heavy Duty, 2RU

DOOR LOCK KEY NUMBER

92268



3106TC45C1224

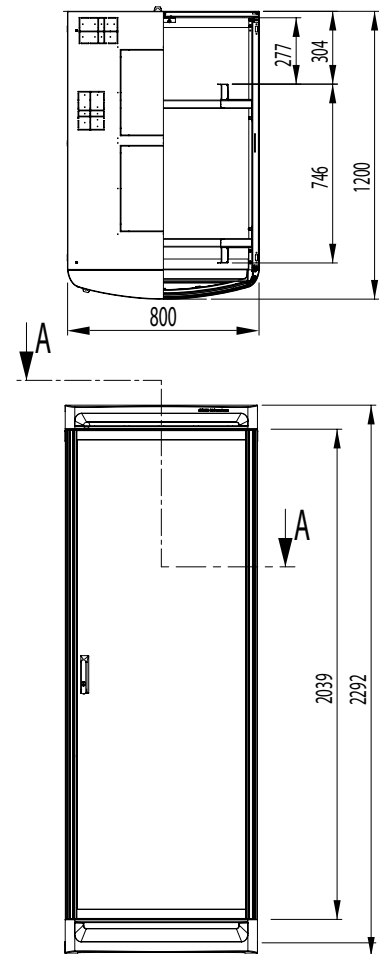

PRODUCT FEATURES

- Curved and tinted front acrylic door.
- No external frame – easy access to rails.
- Removable side and rear doors.
- Adjustable side rails (standard 19" width).

CATALOGUE NUMBER	DESCRIPTION
3106TC45C1224	45RU Complete Clipsal titanium® Cabinet 800mm (W) x 1200mm (D)

18RU Complete Cabinet 605mm x 600mm

The Clipsal Datacomms range of complete cabinets combine trusted reliability with flexibility of design and function.

All cabinets have fully adjustable 19" mounting rails, front and rear, which will meet the needs of the most difficult installation.

The complete cabinet range is available in 605mm and 760mm wide designs with varying depths starting from 600mm to 1200mm. Each cabinet is available in a range of heights and has a comprehensive range of accessories which complement the total cabinet solution.

This offer is manufactured in Australia from high quality materials and can be included in the Clipsal Datacomms' Lifetime Warranty.

DIMENSIONS

Catalogue Number	Height	Width	Depth	Max. Usable Depth
3106CAB18C60	925mm	605mm	600mm	484mm

CABLE ENTRIES

Top	4 of 50mm x 100mm break outs 1 of 360mm x 360mm break out
Bottom	1 of 410mm x 440mm break out

ACCESSORIES AVAILABLE

Catalogue Number	Description
3106CT18U15	18RU Cable Tray 150mm
3106CT18U22	18RU Cable Tray 225mm
3106CT18U30	18RU Cable Tray 300mm
3106CAS60LD	Light Duty Castor Set
3106CAS60HD	Heavy Duty Castor Set
3106EK	Universal Earth Kit
3106FT260	2 Fan Tray
3106FT460	4 Fan Tray
3106SC (2U23 TO 3U30)	Shelf Cantilever
3106SF (1U41 TO 1U45)	Shelf Fixed
3106ST (1U41)	Shelf Telescopic
3106PH (6W1FP TO 10W2FP)	Horizontal Power Rails
3106PV (10W2FP TO 10W2FP)	Vertical Power Rails
3106TP60	Top Plain
3106TR60	Top Raised
3106TV60	Top Ventilated
3106CD55/100	Chimney
3106CD85/160	Chimney
3106SPL	Side Panel Lock

DOOR LOCK KEY NUMBER

CL003



3106CAB18C60

PRODUCT FEATURES

- Tinted front acrylic door.
- Steel frame with plain top.
- Lockable (key) lift off front acrylic and rear metal doors.
- Flexible left and right hand hinge system for front and rear doors.
- Removable metal side panels with snap locks (provision for key lock).
- Four vertical panel mounts adjustable through entire depth of cabinet.
- Leveling feet fitted as standard to all free standing cabinets.
- Ventilation slots in base.
- Comprehensive accessories available.

CATALOGUE NUMBER DESCRIPTION

3106CAB18C60 18RU Complete Cabinet, 605mm (W) x 600mm (D), APO Grey

27RU Complete Cabinet 605mm x 600mm

The Clipsal Datacomms range of complete cabinets combine trusted reliability with flexibility of design and function.

All cabinets have fully adjustable 19" mounting rails, front and rear, which will meet the needs of the most difficult installation.

The complete cabinet range is available in 605mm and 760mm wide designs, with varying depths starting from 600mm to 1200mm. Each cabinet is available in a range of heights and has a comprehensive range of accessories which complement the total cabinet solution.

This offer is manufactured in Australia from high quality materials and can be included in the Clipsal Datacomms' Lifetime Warranty.

DIMENSIONS

Catalogue Number	Height	Width	Depth	Max. Usable Depth
3106CAB27C60	1360mm	605mm	600mm	484mm

CABLE ENTRIES

Top	4 of 50mm x 100mm break outs 1 of 360mm x 360mm break out
Bottom	1 of 410mm x 440mm break out

ACCESSORIES AVAILABLE

Catalogue Number	Description
3106CT27U15	27RU Cable Tray 150mm
3106CT27U22	27RU Cable Tray 225mm
3106CAS60LD	Light Duty Castor Set
3106CAS60HD	Heavy Duty Castor Set
3106EK	Universal Earth Kit
3106FT260	2 Fan Tray
3106FT460	4 Fan Tray
3106SC (2U23 TO 5U50)	Shelf Cantilever
3106SF (1U41 TO 1U45)	Shelf Fixed
3106ST (1U41)	Shelf Fixed
3106PH (6W1FP TO 10W2FP)	Horizontal Power Rails
3106PV (10W2FP TO 10WJB)	Vertical Power Rails
3106TP60	Top Plain
3106TR60	Top Raised
3106TV60	Top Ventilated
3106CD55/100	Chimney
3106CD85/160	Chimney
3106SPL	Side Panel Lock

DOOR LOCK KEY NUMBER

CL003



3106CAB27C60

PRODUCT FEATURES

- Tinted front acrylic door.
- Steel frame with plain top.
- Lockable (key) lift off front acrylic and rear metal doors.
- Flexible left and right hand hinge system for front and rear doors.
- Removable metal side panels with snap locks (provision for key lock).
- Four vertical panel mounts adjustable through entire depth of cabinet.
- Leveling feet fitted as standard to all free standing cabinets.
- Ventilation slots in base.
- Comprehensive accessories available.

CATALOGUE NUMBER DESCRIPTION

3106CAB27C60 27RU Complete Cabinet, 605mm (W) x 600mm (D), APO Grey

39RU Complete Cabinet 605mm x 600mm

The Clipsal Datacomms range of complete cabinets combine trusted reliability with flexibility of design and function.

All cabinets have fully adjustable 19" mounting rails, front and rear, which will meet the needs of the most difficult installation.

The complete cabinet range is available in 605mm and 760mm wide designs, with varying depths starting from 600mm to 1200mm. Each cabinet is available in a range of heights and has a comprehensive range of accessories which complement the total cabinet solution.

This offer is manufactured in Australia from high quality materials and can be included in the Clipsal Datacomms' Lifetime Warranty.

DIMENSIONS

Catalogue Number	Height	Width	Depth	Max. Usable Depth
3106CAB39C60	1859mm	605mm	600mm	484mm

CABLE ENTRIES

Top	4 of 50mm x 100mm break outs 1 of 360mm x 360mm break out
Bottom	1 of 410mm x 440mm break out

ACCESSORIES AVAILABLE

Catalogue Number	Description
3106CT39U15	39RU Cable Tray 150mm
3106CT39U22	39RU Cable Tray 225mm
3106CT39U30	39RU Cable Tray 300mm
3106CAS60LD	Light Duty Castor Set
3106CAS60HD	Heavy Duty Castor Set
3106EK	Universal Earth Kit
3106FT260	2 Fan Tray
3106FT460	4 Fan Tray
3106SC (2U23 TO 3U30)	Shelf Cantilever
3106SF (1U41 TO 1U45)	Shelf Fixed
3106ST (1U41)	Shelf Telescopic
3106PH (6W1FP TO 10W2FP)	Horizontal Power Rails
3106PV (10W2FP TO 13W2FP)	Vertical Power Rails
3106TP60	Top Plain
3106TR60	Top Raised
3106TV60	Top Ventilated
3106CD55/100	Chimney
3106CD85/160	Chimney
3106SPL	Side Panel Lock

DOOR LOCK KEY NUMBER

CL003



3106CAB39C60

PRODUCT FEATURES

- Tinted front acrylic door.
- Steel frame with plain top.
- Lockable (key) lift off front acrylic and rear metal doors.
- Flexible left and right hand hinge system for front and rear doors.
- Removable metal side panels with snap locks (provision for key lock).
- Four vertical panel mounts adjustable through entire depth of cabinet.
- Leveling feet fitted as standard to all free standing cabinets.
- Ventilation slots in base.
- Comprehensive accessories available.

CATALOGUE NUMBER DESCRIPTION

3106CAB39C60 39RU Complete Cabinet, 605mm (W) x 600mm (D), APO Grey

39RU Complete Cabinet 605mm x 800mm

The Clipsal Datacomms range of complete cabinets combine trusted reliability with flexibility of design and function.

All cabinets have fully adjustable 19" mounting rails, front and rear, which will meet the needs of the most difficult installation.

The complete cabinet range is available in 605mm and 760mm wide designs, with varying depths starting from 600mm to 1200mm. Each cabinet is available in a range of heights and has a comprehensive range of accessories which complement the total cabinet solution.

This offer is manufactured in Australia from high quality materials and can be included in the Clipsal Datacomms' Lifetime Warranty.

DIMENSIONS

Catalogue Number	Height	Width	Depth	Max. Usable Depth
3106CAB39C80	1859mm	605mm	800mm	684mm

CABLE ENTRIES

Top	4 of 50mm x 100mm break outs 1 of 360mm x 360mm break out
Bottom	1 of 410mm x 440mm break out

ACCESSORIES AVAILABLE

Catalogue Number	Description
3106CT39U15	39RU Cable Tray 150mm
3106CT39U22	39RU Cable Tray 225mm
3106CT39U30	39RU Cable Tray 300mm
3106CAS60LD	Light Duty Castor Set
3106CAS80HD	Heavy Duty Castor Set
3106EK	Universal Earth Kit
3106FT260	2 Fan Tray
3106FT460	4 Fan Tray
3106SC (2U23 TO 6U60)	Shelf Cantilever
3106SF (1U41 TO 1U61)	Shelf Fixed
3106ST (1U41 TO 1U61)	Shelf Telescopic
3106PH (6W1FP TO 10W2FP)	Horizontal Power Rails
3106PV (10W2FP TO 13W2FP)	Vertical Power Rails
3106TP60	Top Plain
3106TR80	Top Raised
3106TV60	Top Ventilated
3106CD55/100	Chimney
3106CD85/160	Chimney
3106SPL	Side Panel Lock

DOOR LOCK KEY NUMBER

CL003



3106CAB39C80

PRODUCT FEATURES

- Tinted front acrylic door.
- Steel frame with plain top.
- Lockable (key) lift off front acrylic and rear metal doors.
- Flexible left and right hand hinge system for front and rear doors.
- Removable metal side panels with snap locks (provision for key lock).
- Four vertical panel mounts adjustable through entire depth of cabinet.
- Leveling feet fitted as standard to all free standing cabinets.
- Ventilation slots in base.
- Comprehensive accessories available.

CATALOGUE NUMBER DESCRIPTION

3106CAB39C80 39RU Complete Cabinet, 605mm (W) x 800mm (D), APO Grey

45RU Complete Cabinet 605mm x 600mm

The Clipsal Datacomms range of complete cabinets combine trusted reliability with flexibility of design and function.

All cabinets have fully adjustable 19" mounting rails, front and rear, which will meet the needs of the most difficult installation.

The complete cabinet range is available in 605mm and 760mm wide designs, with varying depths starting from 600mm to 1200mm. Each cabinet is available in a range of heights and has a comprehensive range of accessories which complement the total cabinet solution.

This offer is manufactured in Australia from high quality materials and can be included in the Clipsal Datacomms' Lifetime Warranty.

DIMENSIONS

Catalogue Number	Height	Width	Depth	Max. Usable Depth
3106CAB45C60	2125mm	605mm	600mm	484mm

CABLE ENTRIES

Top	4 of 50mm x 100mm break outs 1 of 360mm x 360mm break out
Bottom	1 of 410mm x 440mm break out

ACCESSORIES AVAILABLE

Catalogue Number	Description
3106CT45U15	45RU Cable Tray 150mm
3106CT45U22	45RU Cable Tray 225mm
3106CT45U30	45RU Cable Tray 300mm
3106CAS60LD	Light Duty Castor Set
3106CAS60HD	Heavy Duty Castor Set
3106EK	Universal Earth Kit
3106FT260	2 Fan Tray
3106FT460	4 Fan Tray
3106SC (2U23 to 3U30)	Shelf Cantilever
3106SF (1U41 to 1U45)	Shelf Fixed
3106ST (1U41)	Shelf Telescopic
3106PH (6W1FP to 10W2FP)	Horizontal Power Rails
3106PV (10W2FP to 20W2FP)	Vertical Power Rails
3106TP60	Top Plain
3106TR60	Top Raised
3106TV60	Top Ventilated
3106CD55/100	Chimney
3106CD85/160	Chimney
3106SPL	Side Panel Lock

DOOR LOCK KEY NUMBER

CL003



3106CAB45C60

PRODUCT FEATURES

- Tinted front acrylic door.
- Steel frame with plain top.
- Lockable (key) lift off front acrylic and rear metal doors.
- Flexible left and right hand hinge system for front and rear doors.
- Removable metal side panels with snap locks (provision for key lock).
- Four vertical panel mounts adjustable through entire depth of cabinet.
- Leveling feet fitted as standard to all free standing cabinets.
- Ventilation slots in base.
- Comprehensive accessories available.

CATALOGUE NUMBER DESCRIPTION

3106CAB45C60 45RU Complete Cabinet, 605mm (W) x 600mm (D), APO Grey

45RU Complete Cabinet 605mm x 800mm

The Clipsal Datacomms range of complete cabinets combine trusted reliability with flexibility of design and function.

All cabinets have fully adjustable 19" mounting rails, front and rear, which will meet the needs of the most difficult installation.

The complete cabinet range is available in 605mm and 760mm wide designs, with varying depths starting from 600mm to 1200mm. Each cabinet is available in a range of heights and has a comprehensive range of accessories which complement the total cabinet solution.

This offer is manufactured in Australia from high quality materials and can be included in the Clipsal Datacomms' Lifetime Warranty.

DIMENSIONS

Catalogue Number	Height	Width	Depth	Max. Usable Depth
3106CAB45C80	2125mm	605mm	800mm	684mm

CABLE ENTRIES

Top	4 of 50mm x 100mm break outs 1 of 360mm x 360mm break out
Bottom	1 of 410mm x 440mm break out

ACCESSORIES AVAILABLE

Catalogue Number	Description
3106CT45U15	45RU Cable Tray 150mm
3106CT45U22	45RU Cable Tray 225mm
3106CT45U30	45RU Cable Tray 300mm
3106CAS60LD	Light Duty Castor Set
3106CAS80HD	Heavy Duty Castor Set
3106EK	Universal Earth Kit
3106FT260	2 Fan Tray
3106FT460	4 Fan Tray
3106SC (2U23 to 6U60)	Shelf Cantilever
3106SF (1U41 to 1U61)	Shelf Fixed
3106ST (1U41 to 1U61)	Shelf Telescopic
3106PH (6W1FP to 10W2FP)	Horizontal Power Rails
3106PV (10W2FP to 20W2FP)	Vertical Power Rails
3106TP60	Top Plain
3106TR80	Top Raised
3106TV60	Top Ventilated
3106CD55/100	Chimney
3106CD85/160	Chimney
3106SPL	Side Panel Lock

DOOR LOCK KEY NUMBER

CL003



3106CAB45C80

PRODUCT FEATURES

- Tinted front acrylic door.
- Steel frame with plain top.
- Lockable (key) lift off front acrylic and rear metal doors.
- Flexible left and right hand hinge system for front and rear doors.
- Removable metal side panels with snap locks (provision for key lock).
- Four vertical panel mounts adjustable through entire depth of cabinet.
- Leveling feet fitted as standard to all free standing cabinets.
- Ventilation slots in base.
- Comprehensive accessories available.

CATALOGUE NUMBER DESCRIPTION

3106CAB45C80 45RU Complete Cabinet, 605mm (W) x 800mm (D), APO Grey

45RU Complete Cabinet 605mm x 900mm

The Clipsal Datacomms range of complete cabinets combine trusted reliability with flexibility of design and function.

All cabinets have fully adjustable 19" mounting rails, front and rear, which will meet the needs of the most difficult installation.

The complete cabinet range is available in 605mm and 760mm wide designs, with varying depths starting from 600mm to 1200mm. Each cabinet is available in a range of heights and has a comprehensive range of accessories which complement the total cabinet solution.

This offer is manufactured in Australia from high quality materials and can be included in the Clipsal Datacomms' Lifetime Warranty.

DIMENSIONS

Catalogue Number	Height	Width	Depth	Max. Usable Depth
3106CAB45C90	2125mm	605mm	900mm	784mm

CABLE ENTRIES

Top	4 of 50mm x 100mm break outs 1 of 360mm x 360mm break out
Bottom	1 of 410mm x 440mm break out

ACCESSORIES AVAILABLE

Catalogue Number	Description
3106CT45U15	45RU Cable Tray 150mm
3106CT45U22	45RU Cable Tray 225mm
3106CT45U30	45RU Cable Tray 300mm
3106CAS60LD	Light Duty Castor Set
3106CAS90HD	Heavy Duty Castor Set
3106EK	Universal Earth Kit
3106FT260	2 Fan Tray
3106FT460	4 Fan Tray
3106SC (2U23 to 6U60)	Shelf Cantilever
3106SF (1U41 to 1U71)	Shelf Fixed
3106ST (1U41 to 2U71HD)	Shelf Telescopic
3106PH (6W1FP to 10W2FP)	Horizontal Power Rails
3106PV (10W2FP to 20W2FP)	Vertical Power Rails
3106TP60	Top Plain
3106TV60	Top Ventilated
3106CD55/100	Chimney
3106CD85/160	Chimney
3106SPL	Side Panel Lock

DOOR LOCK KEY NUMBER

CL003



3106CAB45C90

PRODUCT FEATURES

- Tinted front acrylic door.
- Steel frame with plain top.
- Lockable (key) lift off front acrylic and rear metal doors.
- Flexible left and right hand hinge system for front and rear doors.
- Removable metal side panels with snap locks (provision for key lock).
- Four vertical panel mounts adjustable through entire depth of cabinet.
- Leveling feet fitted as standard to all free standing cabinets.
- Ventilation slots in base.
- Comprehensive accessories available.

CATALOGUE NUMBER DESCRIPTION

3106CAB45C90 45RU Complete Cabinet, 605mm (W) x 900mm (D), APO Grey

45RU Complete Cabinet 605mm x 1000mm

The Clipsal Datacomms range of complete cabinets combine trusted reliability with flexibility of design and function.

All cabinets have fully adjustable 19" mounting rails, front and rear, which will meet the needs of the most difficult installation.

The complete cabinet range is available in 605mm and 760mm wide designs, with varying depths starting from 600mm to 1200mm. Each cabinet is available in a range of heights and has a comprehensive range of accessories which complement the total cabinet solution.

This offer is manufactured in Australia from high quality materials and can be included in the Clipsal Datacomms' Lifetime Warranty.

DIMENSIONS

Catalogue Number	Height	Width	Depth	Max. Usable Depth
3106CAB45C100	2125mm	605mm	1000mm	884mm

CABLE ENTRIES

Top	4 of 50mm x 100mm break outs 1 of 360mm x 360mm break out
Bottom	1 of 410mm x 440mm break out

ACCESSORIES AVAILABLE

Catalogue Number	Description
3106CT45U15	45RU Cable Tray 150mm
3106CT45U22	45RU Cable Tray 225mm
3106CT45U30	45RU Cable Tray 300mm
3106CAS60LD	Light Duty Castor Set
3106EK	Universal Earth Kit
3106FT260	2 Fan Tray
3106FT460	4 Fan Tray
3106SC (2U23 to 6U60)	Shelf Cantilever
3106SF (1U41 to 1U81)	Shelf Fixed
3106ST (1U41 TO 2U71HD)	Shelf Telescopic
3106PH (6W1FP to 10W2FP)	Horizontal Power Rails
3106PV (10W2FP to 20W2FP)	Vertical Power Rails
3106TP60	Top Plain
3106TV60	Top Ventilated
3106CD55/100	Chimney
3106CD85/160	Chimney
3106SPL	Side Panel Lock

DOOR LOCK KEY NUMBER

CL003



3106CAB45C100

PRODUCT FEATURES

- Tinted front acrylic door.
- Steel frame with plain top.
- Lockable (key) lift off front acrylic and rear metal doors.
- Flexible left and right hand hinge system for front and rear doors.
- Removable metal side panels with snap locks (provision for key lock).
- Four vertical panel mounts adjustable through entire depth of cabinet.
- Leveling feet fitted as standard to all free standing cabinets.
- Ventilation slots in base.
- Comprehensive accessories available.

CATALOGUE NUMBER DESCRIPTION

3106CAB45C100 45RU Complete Cabinet, 605mm (W) x 1000mm (D), APO Grey

45RU Complete Cabinet 605mm x 1100mm

The Clipsal Datacomms range of complete cabinets combine trusted reliability with flexibility of design and function.

All cabinets have fully adjustable 19" mounting rails, front and rear, which will meet the needs of the most difficult installation.

The complete cabinet range is available in 605mm and 760mm wide designs, with varying depths starting from 600mm to 1200mm. Each cabinet is available in a range of heights and has a comprehensive range of accessories which complement the total cabinet solution.

This offer is manufactured in Australia from high quality materials and can be included in the Clipsal Datacomms' Lifetime Warranty.

DIMENSIONS

Catalogue Number	Height	Width	Depth	Max. Usable Depth
3106CAB45C110	2125mm	605mm	1100mm	984mm

CABLE ENTRIES

Top	4 of 50mm x 100mm break outs 1 of 360mm x 360mm break out
Bottom	1 of 410mm x 440mm break out

ACCESSORIES AVAILABLE

Catalogue Number	Description
3106CT45U15	45RU Cable Tray 150mm
3106CT45U22	45RU Cable Tray 225mm
3106CT45U30	45RU Cable Tray 300mm
3106CAS60LD	Light Duty Castor Set
3106EK	Universal Earth Kit
3106FT260	2 Fan Tray
3106FT460	4 Fan Tray
3106SC (2U23 to 6U60)	Shelf Cantilever
3106SF (1U41 to 1U91)	Shelf Fixed
3106ST (1U41 to 2U71HD)	Shelf Telescopic
3106PH (6W1FP to 10W2FP)	Horizontal Power Rails
3106PV (10W2FP to 20W2FP)	Vertical Power Rails
3106TP60	Top Plain
3106TV60	Top Ventilated
3106CD55/100	Chimney
3106CD85/160	Chimney
3106SPL	Side Panel Lock

DOOR LOCK KEY NUMBER

CL003



3106CAB45C110

PRODUCT FEATURES

- Tinted front acrylic door.
- Steel frame with plain top.
- Lockable (key) lift off front acrylic and rear metal doors.
- Flexible left and right hand hinge system for front and rear doors.
- Removable metal side panels with snap locks (provision for key lock).
- Four vertical panel mounts adjustable through entire depth of cabinet.
- Leveling feet fitted as standard to all free standing cabinets.
- Ventilation slots in base.
- Comprehensive accessories available.

CATALOGUE NUMBER DESCRIPTION

3106CAB45C110 45RU Complete Cabinet, 605mm (W) x 1100mm (D), APO Grey

45RU Complete Cabinet 605mm x 1200mm

The Clipsal Datacomms range of complete cabinets combine trusted reliability with flexibility of design and function.

All cabinets have fully adjustable 19" mounting rails, front and rear, which will meet the needs of the most difficult installation.

The complete cabinet range is available in 605mm and 760mm wide designs, with varying depths starting from 600mm to 1200mm. Each cabinet is available in a range of heights and has a comprehensive range of accessories which complement the total cabinet solution.

This offer is manufactured in Australia from high quality materials and can be included in the Clipsal Datacomms' Lifetime Warranty.

DIMENSIONS

Catalogue Number	Height	Width	Depth	Max. Usable Depth
3106CAB45C120	2125mm	605mm	1200mm	1084mm

CABLE ENTRIES

Top	4 of 50mm x 100mm break outs 1 of 360mm x 360mm break out
Bottom	1 of 410mm x 440mm break out

ACCESSORIES AVAILABLE

Catalogue Number	Description
3106CT45U15	45RU Cable Tray 150mm
3106CT45U22	45RU Cable Tray 225mm
3106CT45U30	45RU Cable Tray 300mm
3106CAS60LD	Light Duty Castor Set
3106EK	Universal Earth Kit
3106FT260	2 Fan Tray
3106FT460	4 Fan Tray
3106SC (2U23 to 6U60)	Shelf Cantilever
3106SF (1U41 to 1U101)	Shelf Fixed
3106ST (1U41 to 2U71HD)	Shelf Telescopic
3106PH (6W1FP to 10W2FP)	Horizontal Power Rails
3106PV (10W2FP to 20W2FP)	Vertical Power Rails
3106TP60	Top Plain
3106TV60	Top Ventilated
3106CD55/100	Chimney
3106CD85/160	Chimney
3106SPL	Side Panel Lock

DOOR LOCK KEY NUMBER

CL003



3106CAB45C120

PRODUCT FEATURES

- Tinted front acrylic door.
- Steel frame with plain top.
- Lockable (key) lift off front acrylic and rear metal doors.
- Flexible left and right hand hinge system for front and rear doors.
- Removable metal side panels with snap locks (provision for key lock).
- Four vertical panel mounts adjustable through entire depth of cabinet.
- Leveling feet fitted as standard to all free standing cabinets.
- Ventilation slots in base.
- Comprehensive accessories available.

CATALOGUE NUMBER	DESCRIPTION
3106CAB45C120	45RU Complete Cabinet, 605mm (W) x 1200mm (D), APO Grey

45RU Complete Cabinet 760mm x 800mm

The Clipsal Datacomms range of complete cabinets combine trusted reliability with flexibility of design and function.

All cabinets have fully adjustable 19" mounting rails, front and rear, which will meet the needs of the most difficult installation.

The complete cabinet range is available in 605mm and 760mm wide designs, with varying depths starting from 600mm to 1200mm. Each cabinet is available in a range of heights and has a comprehensive range of accessories which complement the total cabinet solution.

This offer is manufactured in Australia from high quality materials and can be included in the Clipsal Datacomms' Lifetime Warranty.

DIMENSIONS

Catalogue Number	Height	Width	Depth	Max. Usable Depth
3106CAB45C824	2125mm	760mm	800mm	684mm

CABLE ENTRIES

Top	4 of 50mm x 100mm break outs 1 of 360mm x 360mm break out
Bottom	1 of 410mm x 440mm break out

ACCESSORIES AVAILABLE

Catalogue Number	Description
3106CT45U15	45RU Cable Tray 150mm
3106CT45U22	45RU Cable Tray 225mm
3106CT45U30	45RU Cable Tray 300mm
3106CAS76LD	Light Duty Castor Set
3106EK	Universal Earth Kit
3106FT260	2 Fan Tray
3106FT460	4 Fan Tray
3106SC (2U23 to 6U60)	Shelf Cantilever
3106SF (1U41 to 1U61)	Shelf Fixed
3106ST (1U41 to 1U61)	Shelf Telescopic
3106PH (6W1FP to 10W2FP)	Horizontal Power Rails
3106PV (10W2FP to 20W2FP)	Vertical Power Rails
3106TP60	Top Plain
3106TV60	Top Ventilated
3106CD55/100	Chimney
3106CD85/160	Chimney
3106SPL	Side Panel Lock

DOOR LOCK KEY NUMBER

CL003



3106CAB45C824

PRODUCT FEATURES

- Tinted front acrylic door.
- Steel frame with plain top.
- Lockable (key) lift off front acrylic and rear metal doors.
- Flexible left and right hand hinge system for front and rear doors.
- Removable metal side panels with snap locks (provision for key lock).
- Four vertical panel mounts adjustable through entire depth of cabinet.
- Leveling feet fitted as standard to all free standing cabinets.
- Ventilation slots in base.
- Comprehensive accessories available.

CATALOGUE NUMBER DESCRIPTION

3106CAB45C824 45RU Complete Cabinet, 760mm (W) x 800mm (D), APO Grey

45RU Complete Cabinet 760mm x 900mm

The Clipsal Datacomms range of complete cabinets combine trusted reliability with flexibility of design and function.

All cabinets have fully adjustable 19" mounting rails, front and rear, which will meet the needs of the most difficult installation.

The complete cabinet range is available in 605mm and 760mm wide designs, with varying depths starting from 600mm to 1200mm. Each cabinet is available in a range of heights and has a comprehensive range of accessories which complement the total cabinet solution.

This offer is manufactured in Australia from high quality materials and can be included in the Clipsal Datacomms' Lifetime Warranty.

DIMENSIONS

Catalogue Number	Height	Width	Depth	Max. Usable Depth
3106CAB45C924	2125mm	760mm	900mm	784mm

CABLE ENTRIES

Top	4 of 50mm x 100mm break outs 1 of 360mm x 360mm break out
Bottom	1 of 410mm x 440mm break out

ACCESSORIES AVAILABLE

Catalogue Number	Description
3106CT45U15	45RU Cable Tray 150mm
3106CT45U22	45RU Cable Tray 225mm
3106CT45U30	45RU Cable Tray 300mm
3106CAS76LD	Light Duty Castor Set
3106EK	Universal Earth Kit
3106FT260	2 Fan Tray
3106FT460	4 Fan Tray
3106SC (2U23 to 6U60)	Shelf Cantilever
3106SF (1U41 to 1U71)	Shelf Fixed
3106ST (1U41 to 2U71HD)	Shelf Telescopic
3106PH (6W1FP to 10W2FP)	Horizontal Power Rails
3106PV (10W2FP to 20W2FP)	Vertical Power Rails
3106TP60	Top Plain
3106TV60	Top Ventilated
3106CD55/100	Chimney
3106CD85/160	Chimney
3106SPL	Side Panel Lock

DOOR LOCK KEY NUMBER

CL003



3106CAB45C924

PRODUCT FEATURES

- Tinted front acrylic door.
- Steel frame with plain top.
- Lockable (key) lift off front acrylic and rear metal doors.
- Flexible left and right hand hinge system for front and rear doors.
- Removable metal side panels with snap locks (provision for key lock).
- Four vertical panel mounts adjustable through entire depth of cabinet.
- Leveling feet fitted as standard to all free standing cabinets.
- Ventilation slots in base.
- Comprehensive accessories available.

CATALOGUE NUMBER DESCRIPTION

3106CAB45C924 45RU Complete Cabinet, 760mm (W) x 900mm (D), APO Grey

45RU Complete Cabinet 760mm x 1000mm

The Clipsal Datacomms range of complete cabinets combine trusted reliability with flexibility of design and function.

All cabinets have fully adjustable 19" mounting rails, front and rear, which will meet the needs of the most difficult installation.

The complete cabinet range is available in 605mm and 760mm wide designs, with varying depths starting from 600mm to 1200mm. Each cabinet is available in a range of heights and has a comprehensive range of accessories which complement the total cabinet solution.

This offer is manufactured in Australia from high quality materials and can be included in the Clipsal Datacomms' Lifetime Warranty.

DIMENSIONS

Catalogue Number	Height	Width	Depth	Max. Usable Depth
3106CAB45C1024	2125mm	760mm	1000mm	884mm

CABLE ENTRIES

Top	4 of 50mm x 100mm break outs 1 of 360mm x 360mm break out
Bottom	1 of 410mm x 440mm break out2

ACCESSORIES AVAILABLE

Catalogue Number	Description
3106CT45U15	45RU Cable Tray 150mm
3106CT45U22	45RU Cable Tray 225mm
3106CT45U30	45RU Cable Tray 300mm
3106CAS76LD	Light Duty Castor Set
3106EK	Universal Earth Kit
3106FT260	2 Fan Tray
3106FT460	4 Fan Tray
3106SC (2U23 to 6U60)	Shelf Cantilever
3106SF (1U41 to 1U81)	Shelf Fixed
3106ST (1U41 TO 2U71HD)	Shelf Telescopic
3106PH (6W1FP to 10W2FP)	Horizontal Power Rails
3106PV (10W2FP to 20W2FP)	Vertical Power Rails
3106TP60	Top Plain
3106TV60	Top Ventilated
3106CD55/100	Chimney
3106CD85/160	Chimney
3106SPL	Side Panel Lock

DOOR LOCK KEY NUMBER

CL003



3106CAB45C1024

PRODUCT FEATURES

- Tinted front acrylic door.
- Steel frame with plain top.
- Lockable (key) lift off front acrylic and rear metal doors.
- Flexible left and right hand hinge system for front and rear doors.
- Removable metal side panels with snap locks (provision for key lock).
- Four vertical panel mounts adjustable through entire depth of cabinet.
- Leveling feet fitted as standard to all free standing cabinets.
- Ventilation slots in base.
- Comprehensive accessories available.

CATALOGUE NUMBER DESCRIPTION

3106CAB45C1024 45RU Complete Cabinet, 760mm (W) x 1000mm (D), APO Grey

45RU Complete Cabinet 760mm x 1100mm

The Clipsal Datacomms range of complete cabinets combine trusted reliability with flexibility of design and function.

All cabinets have fully adjustable 19" mounting rails, front and rear, which will meet the needs of the most difficult installation.

The complete cabinet range is available in 605mm and 760mm wide designs, with varying depths starting from 600mm to 1200mm. Each cabinet is available in a range of heights and has a comprehensive range of accessories which complement the total cabinet solution.

This offer is manufactured in Australia from high quality materials and can be included in the Clipsal Datacomms' Lifetime Warranty.

DIMENSIONS

Catalogue Number	Height	Width	Depth	Max. Usable Depth
3106CAB45C1124	2125mm	760mm	1100mm	984mm

CABLE ENTRIES

Top	4 of 50mm x 100mm break outs 1 of 360mm x 360mm break out
Bottom	1 of 410mm x 440mm break out

ACCESSORIES AVAILABLE

Catalogue Number	Description
3106CT45U15	45RU Cable Tray 150mm
3106CT45U22	45RU Cable Tray 225mm
3106CT45U30	45RU Cable Tray 300mm
3106CAS76LD	Light Duty Castor Set
3106EK	Universal Earth Kit
3106FT260	2 Fan Tray
3106FT460	4 Fan Tray
3106SC (2U23 to 6U60)	Shelf Cantilever
3106SF (1U41 to 1U91)	Shelf Fixed
3106ST (1U41 TO 2U71HD)	Shelf Telescopic
3106PH (6W1FP to 10W2FP)	Horizontal Power Rails
3106PV (10W2FP to 20W2FP)	Vertical Power Rails
3106TP60	Top Plain
3106TV60	Top Ventilated
3106CD55/100	Chimney
3106CD85/160	Chimney
3106SPL	Side Panel Lock

DOOR LOCK KEY NUMBER

CL003



3106CAB45C1124

PRODUCT FEATURES

- Tinted front acrylic door.
- Steel frame with plain top.
- Lockable (key) lift off front acrylic and rear metal doors.
- Flexible left and right hand hinge system for front and rear doors.
- Removable metal side panels with snap locks (provision for key lock).
- Four vertical panel mounts adjustable through entire depth of cabinet.
- Leveling feet fitted as standard to all free standing cabinets.
- Ventilation slots in base.
- Comprehensive accessories available.

CATALOGUE NUMBER DESCRIPTION

3106CAB45C1224 45RU Complete Cabinet, 760mm (W) x 1100mm (D), APO Grey

45RU Complete Cabinet 760mm x 1200mm

The Clipsal Datacomms range of complete cabinets combine trusted reliability with flexibility of design and function.

All cabinets have fully adjustable 19" mounting rails, front and rear, which will meet the needs of the most difficult installation.

The complete cabinet range is available in 605mm and 760mm wide designs, with varying depths starting from 600mm to 1200mm. Each cabinet is available in a range of heights and has a comprehensive range of accessories which complement the total cabinet solution.

This offer is manufactured in Australia from high quality materials and can be included in the Clipsal Datacomms' Lifetime Warranty.

DIMENSIONS

Catalogue Number	Height	Width	Depth	Max. Usable Depth
3106CAB45C1224	2125mm	760mm	1200mm	1084mm

CABLE ENTRIES

Top	4 of 50mm x 100mm break outs 1 of 360mm x 360mm break out
Bottom	1 of 410mm x 440mm break out

ACCESSORIES AVAILABLE

Catalogue Number	Description
3106CT45U15	45RU Cable Tray 150mm
3106CT45U22	45RU Cable Tray 225mm
3106CT45U30	45RU Cable Tray 300mm
3106CAS76LD	Light Duty Castor Set
3106EK	Universal Earth Kit
3106FT260	2 Fan Tray
3106FT460	4 Fan Tray
3106SC (2U23 to 6U60)	Shelf Cantilever
3106SF (1U41 to 1U101)	Shelf Fixed
3106ST (1U41 TO 2U71HD)	Shelf Telescopic
3106PH (6W1FP to 10W2FP)	Horizontal Power Rails
3106PV (10W2FP to 20W2FP)	Vertical Power Rails
3106TP60	Top Plain
3106TV60	Top Ventilated
3106CD55/100	Chimney
3106CD85/160	Chimney
3106SPL	Side Panel Lock

DOOR LOCK KEY NUMBER

CL003



3106CAB45C1224

PRODUCT FEATURES

- Tinted front acrylic door.
- Steel frame with plain top.
- Lockable (key) lift off front acrylic and rear metal doors.
- Flexible left and right hand hinge system for front and rear doors.
- Removable metal side panels with snap locks (provision for key lock).
- Four vertical panel mounts adjustable through entire depth of cabinet.
- Leveling feet fitted as standard to all free standing cabinets.
- Ventilation slots in base.
- Comprehensive accessories available.

CATALOGUE NUMBER DESCRIPTION

3106CAB45C1224 45RU Complete Cabinet, 760mm (W) x 1200mm (D), APO Grey

18RU Frame 605mm x 600mm

The Clipsal range of frames are available in 19" and 24" models.

The frame's steel construction is designed to cope with heavy equipment including servers, network bridges and routers, all without buckling under the load.

DIMENSIONS

Catalogue Number	Height	Width	Depth	Max. Usable Depth
3106CAB18F60	925mm	605mm	600mm	484mm

CABLE ENTRIES

Top	4 of 50mm x 100mm break outs 1 of 360mm x 360mm break out
Bottom Knockout	1 of 410mm x 440mm break out

ACCESSORIES AVAILABLE

Catalogue Number	Description
3106CT18U15	18RU Cable Tray 150mm
3106CT18U22	18RU Cable Tray 225mm
3106CT18U30	18RU Cable Tray 300mm
3106CAS60LD	Light Duty Castor Set
3106CAS60HD	Heavy Duty Castor Set
3106EK	Universal Earth Kit
3106FT260	2 Fan Tray
3106FT460	4 Fan Tray
3106JK	Joining Kit
3106SC (2U23 to 3U30)	Shelf Cantilever
3106SF (1U41 to 1U45)	Shelf Fixed
3106ST (1U41)	Shelf Telescopic
3106PH (6W1FP to 10W2FP)	Horizontal Power Rails
3106PV (10W2FP to 10WJB)	Vertical Power Rails
3106TP60	Top Plain
3106TR60	Top Raised
3106TV60	Top Ventilated
3106AMD18	Door, Acrylic with Metal Surround
3106SP18U60	Side Panel Full Metal, Lockable
3106SPL	Side Panel Lock



3106CAB18F60

PRODUCT FEATURES

- Steel frame with plain top.
- Four vertical panel mounts adjustable through entire depth of frame.
- Leveling feet fitted as standard to all free standing cabinets.
- Ventilation slots in base.
- Comprehensive accessories available.

CATALOGUE NUMBER	DESCRIPTION
3106CAB18F60	18RU Frame 605mm (W) x 600mm (D), APO Grey

27RU Frame 605mm x 600mm

The Clipsal range of frames are available in 19" and 24" models.

The frame's steel construction is designed to cope with heavy equipment including servers, network bridges and routers, all without buckling under the load.

DIMENSIONS

Catalogue Number	Height	Width	Depth	Max. Usable Depth
3106CAB27F60	1360mm	605mm	600mm	484mm

CABLE ENTRIES

Top	<p>4 of 50mm x 100mm break outs</p> <p>1 of 360mm x 360mm break out</p>
Bottom Knockout	<p>1 of 410mm x 440mm break out</p>

ACCESSORIES AVAILABLE

Catalogue Number	Description
3106CT27U15	27RU Cable Tray 150mm
3106CT27U22	27RU Cable Tray 225mm
3106CAS60LD	Light Duty Castor Set
3106CAS60HD	Heavy Duty Castor Set
3106EK	Universal Earth Kit
3106FT260	2 Fan Tray
3106FT460	4 Fan Tray
3106JK	Joining Kit
3106SC (2U23 to 3U30)	Shelf Cantilever
3106SF (1U41 to 1U45)	Shelf Fixed
3106ST (1U41)	Shelf Telescopic
3106PH (6W1FP to 10W2FP)	Horizontal Power Rails
3106PV (10W2FP to 10WJB)	Vertical Power Rails
3106TP60	Top Plain
3106TR60	Top Raised
3106TV60	Top Ventilated
3106AMD27	Door, Acrylic with Metal Surround
3106MD27	Door, Full Metal
3106SP27U60	Side Panel Full Metal, Lockable
3106SPL	Side Panel Lock



3106CAB27F60

PRODUCT FEATURES

- Steel frame with plain top.
- Four vertical panel mounts adjustable through entire depth of frame.
- Leveling feet fitted as standard to all free standing cabinets.
- Ventilation slots in base.
- Comprehensive accessories available.

CATALOGUE NUMBER	DESCRIPTION
3106CAB27F60	27RU Frame 605mm (W) x 600mm (D), APO Grey

39RU Frame 605mm x 600mm

The Clipsal range of frames are available in 19" and 24" models.

The frame's steel construction is designed to cope with heavy equipment including servers, network bridges and routers, all without buckling under the load.

DIMENSIONS

Catalogue Number	Height	Width	Depth	Max. Usable Depth
3106CAB39F60	1859mm	605mm	600mm	484mm

CABLE ENTRIES

Top	4 of 50mm x 100mm break outs 1 of 360mm x 360mm break out
Bottom Knockout	1 of 410mm x 440mm break out

ACCESSORIES AVAILABLE

Catalogue number	Description
3106CT39U15	39RU Cable Tray 150mm
3106CT39U22	39RU Cable Tray 225mm
3106CT39U30	39RU Cable Tray 300mm
3106CAS60LD	Light Duty Castor Set
3106CAS60HD	Heavy Duty Castor Set
3106EK	Universal Earth Kit
3106FT260	2 Fan Tray
3106FT460	4 Fan Tray
3106JK	Joining Kit
3106SC (2U23 to 3U30)	Shelf Cantilever
3106SF (1U41 to 1U45)	Shelf Fixed
3106ST (1U41)	Shelf Telescopic
3106PH (6W1FP to 10W2FP)	Horizontal Power Rails
3106PV (10W2FP to 13W2FP)	Vertical Power Rails
3106TP60	Top Plain
3106TR60	Top Raised
3106TV60	Top Ventilated
3106AMD39	Door, Acrylic with Metal Surround
3106MD39	Door, Full Metal
3106SP39U60	Side Panel Full Metal, Lockable
3106SPL	Side Panel Lock



3106CAB39F60

PRODUCT FEATURES

- Steel frame with plain top.
- Four vertical panel mounts adjustable through entire depth of frame.
- Leveling feet fitted as standard to all free standing cabinets.
- Ventilation slots in base.
- Comprehensive accessories available.

CATALOGUE NUMBER	DESCRIPTION
3106CAB39F60	39RU Frame 605mm (W) x 600mm (D), APO Grey

39RU Frame 605mm x 800mm

The Clipsal range of frames are available in 19" and 24" models.

The frame's steel construction is designed to cope with heavy equipment including servers, network bridges and routers, all without buckling under the load.

DIMENSIONS

Catalogue Number	Height	Width	Depth	Max. Usable Depth
3106CAB39F80	1859mm	605mm	800mm	684mm

CABLE ENTRIES

Top	4 of 50mm x 100mm break outs 1 of 360mm x 360mm break out
Bottom	1 of 410mm x 440mm break out

ACCESSORIES AVAILABLE

Catalogue Number	Description
3106CT39U15	39RU Cable Tray 150mm
3106CT39U22	39RU Cable Tray 225mm
3106CT39U30	39RU Cable Tray 300mm
3106CAS60LD	Light Duty Castor Set
3106CAS80HD	Heavy Duty Castor Set
3106EK	Universal Earth Kit
3106FT260	2 Fan Tray
3106FT460	4 Fan Tray
3106JK	Joining Kit
3106SC (2U23 to 6U60)	Shelf Cantilever
3106SF (1U41 to 1U61)	Shelf Fixed
3106ST (1U61)	Shelf Telescopic
3106PH (6W1FP to 10W2FP)	Horizontal Power Rails
3106PV (10W2FP to 13W2FP)	Vertical Power Rails
3106TP60	Top Plain
3106TR80	Top Raised
3106TV60	Top Ventilated
3106AMD39	Door, Acrylic with Metal Surround
3106MD39	Door, Full Metal
3106SP39U80	Side Panel Full Metal, Lockable
3106SPL	Side Panel Lock



3106CAB39F80

PRODUCT FEATURES

- Steel frame with plain top.
- Four vertical panel mounts adjustable through entire depth of frame.
- Leveling feet fitted as standard to all free standing cabinets.
- Ventilation slots in base.
- Comprehensive accessories available.

CATALOGUE NUMBER	DESCRIPTION
3106CAB39F80	39RU Frame 605mm (W) x 800mm (D), APO Grey

45RU Frame 605mm x 600mm

The Clipsal range of frames are available in 19" and 24" models.

The frame's steel construction is designed to cope with heavy equipment including servers, network bridges and routers, all without buckling under the load.

DIMENSIONS

Catalogue Number	Height	Width	Depth	Max. Usable Depth
3106CAB45F60	2125mm	605mm	600mm	484mm

CABLE ENTRIES

Top	4 of 50mm x 100mm knock outs 1 of 360mm x 360mm knock out
Bottom	1 of 410mm x 440mm knock out

ACCESSORIES AVAILABLE

Catalogue Number	Description
3106CT45U15	45RU Cable Tray 150mm
3106CT45U22	45RU Cable Tray 225mm
3106CT45U30	45RU Cable Tray 300mm
3106CAS60LD	Light Duty Castor Set
3106CAS60HD	Heavy Duty Castor Set
3106EK	Universal Earth Kit
3106FT260	2 Fan Tray
3106FT460	4 Fan Tray
3106JK	Joining Kit
3106SC (2U23 to 3U30)	Shelf Cantilever
3106SF (1U41 to 1U45)	Shelf Fixed
3106ST (1U41)	Shelf Telescopic
3106PH (6W1FP to 10W2FP)	Horizontal Power Rails
3106PV (10W2FP to 20W2FP)	Vertical Power Rails
3106TP60	Top Plain
3106TR60	Top Raised
3106TV60	Top Ventilated
3106AMD45	Door, Acrylic with Metal Surround
3106GD45	Door, Glass with Metal Surround
3106MD45	Door, Full Metal
3106SP45U60	Side Panel Full Metal, Lockable
3106SPL	Side Panel Lock



3106CAB45F60

PRODUCT FEATURES

- Steel frame with plain top.
- Four vertical panel mounts adjustable through entire depth of frame.
- Leveling feet fitted as standard to all free standing cabinets.
- Ventilation slots in base.
- Comprehensive accessories available.

CATALOGUE NUMBER	DESCRIPTION
3106CAB45F60	45RU Frame 605mm (W) x 600mm (D), APO Grey

45RU Frame 605mm x 800mm

The Clipsal range of frames are available in 19" and 24" models.

The frame's steel construction is designed to cope with heavy equipment including servers, network bridges and routers, all without buckling under the load.

DIMENSIONS

Catalogue Number	Height	Width	Depth	Max. Usable Depth
3106CAB45F80	2125mm	605mm	800mm	684mm

CABLE ENTRIES

Top	4 of 50mm x 100mm break outs 1 of 360mm x 360mm break out
Bottom	1 of 410mm x 440mm break out

ACCESSORIES AVAILABLE

Catalogue Number	Description
3106CT45U15	45RU Cable Tray 150mm
3106CT45U22	45RU Cable Tray 225mm
3106CT45U30	45RU Cable Tray 300mm
3106CAS60LD	Light Duty Castor Set
3106CAS80HD	Heavy Duty Castor Set
3106EK	Universal Earth Kit
3106FT260	2 Fan Tray
3106FT460	4 Fan Tray
3106JK	Joining Kit
3106SC (2U23 to 6U60)	Shelf Cantilever
3106SF (1U41 to 1U61)	Shelf Fixed
3106ST (1U61)	Shelf Telescopic
3106PH (6W1FP to 10W2FP)	Horizontal Power Rails
3106PV (10W2FP to 20W2FP)	Vertical Power Rails
3106TP60	Top Plain
3106TR80	Top Raised
3106TV60	Top Ventilated
3106AMD45	Door, Acrylic with Metal Surround
3106GD45	Door, Glass with Metal Surround
3106MD45	Door, Full Metal
3106SP45U80	Side Panel Full Metal, Lockable
3106SPL	Side Panel Lock



3106CAB45F80

PRODUCT FEATURES

- Steel frame with plain top.
- Four vertical panel mounts adjustable through entire depth of frame.
- Leveling feet fitted as standard to all free standing cabinets.
- Ventilation slots in base.
- Comprehensive accessories available.

CATALOGUE NUMBER DESCRIPTION

3106CAB45F80 45RU Frame 605mm (W) x 800mm (D), APO Grey

45RU Frame 605mm x 900mm

The Clipsal range of frames are available in 19" and 24" models.

The frame's steel construction is designed to cope with heavy equipment including servers, network bridges and routers, all without buckling under the load.

DIMENSIONS

Catalogue Number	Height	Width	Depth	Max. Usable Depth
3106CAB45F90	2125mm	605mm	900mm	784mm

CABLE ENTRIES

Top	4 of 50mm x 100mm knock outs 1 of 360mm x 360mm knock out
Bottom	1 of 410mm x 440mm knock out

ACCESSORIES AVAILABLE

Catalogue Number	Description
3106CT45U15	45RU Cable Tray 150mm
3106CT45U22	45RU Cable Tray 225mm
3106CT45U30	45RU Cable Tray 300mm
3106CAS60LD	Light Duty Castor Set
3106CAS90HD	Heavy Duty Castor Set
3106EK	Universal Earth Kit
3106FT260	2 Fan Tray
3106FT460	4 Fan Tray
3106JK	Joining Kit
3106SC (2U23 to 6U60)	Shelf Cantilever
3106SF (1U41 to 1U71)	Shelf Fixed
3106ST (1U41 to 2U71HD)	Shelf Telescopic
3106PH (6W1FP to 10W2FP)	Horizontal Power Rails
3106PV (10W2FP to 20W2FP)	Vertical Power Rails
3106TP60	Top Plain
3106TV60	Top Ventilated
3106AMD45	Door, Acrylic with Metal Surround
3106GD45	Door, Glass with Metal Surround
3106MD45	Door, Full Metal
3106SP45U90	Side Panel Full Metal, Lockable
3106SPL	Side Panel Lock



3106CAB45F90

PRODUCT FEATURES

- Steel frame with plain top.
- Four vertical panel mounts adjustable through entire depth of frame.
- Leveling feet fitted as standard to all free standing cabinets.
- Ventilation slots in base.
- Comprehensive accessories available.

CATALOGUE NUMBER	DESCRIPTION
3106CAB45F90	45RU Frame 605mm (W) x 900mm (D), APO Grey

45RU Frame 605mm x 1000mm

The Clipsal range of frames are available in 19" and 24" models.

The frame's steel construction is designed to cope with heavy equipment including servers, network bridges and routers, all without buckling under the load.

DIMENSIONS

Catalogue Number	Height	Width	Depth	Max. Usable Depth
3106CAB45F100	2125mm	605mm	1000mm	884mm

CABLE ENTRIES

Top	4 of 50mm x 100mm break outs 1 of 360mm x 360mm break out
Bottom	1 of 410mm x 440mm break out

ACCESSORIES AVAILABLE

Catalogue Number	Description
3106CT45U15	45RU Cable Tray 150mm
3106CT45U22	45RU Cable Tray 225mm
3106CT45U30	45RU Cable Tray 300mm
3106CAS60LD	Light Duty Castor Set
3106CAS60HD	Heavy Duty Castor Set
3106EK	Universal Earth Kit
3106FT260	2 Fan Tray
3106FT460	4 Fan Tray
3106JK	Joining Kit
3106SC (2U23 to 6U60)	Shelf Cantilever
3106SF (1U41 to 1U81)	Shelf Fixed
3106ST (1U41 to 2U71HD)	Shelf Telescopic
3106PH (6W1FP to 10W2FP)	Horizontal Power Rails
3106PV (10W2FP to 20W2FP)	Vertical Power Rails
3106TP60	Top Plain
3106TV60	Top Ventilated
3106AMD45	Door, Acrylic with Metal Surround
3106GD45	Door, Glass with Metal Surround
3106MD45	Door, Full Metal
3106SP45U100	Side Panel Full Metal, Lockable
3106SPL	Side Panel Lock



3106CAB45F100

PRODUCT FEATURES

- Steel frame with plain top.
- Four vertical panel mounts adjustable through entire depth of frame.
- Leveling feet fitted as standard to all free standing cabinets.
- Ventilation slots in base.
- Comprehensive accessories available.

CATALOGUE NUMBER DESCRIPTION

3106CAB45F100 45RU Frame 605mm (W) x 1000mm (D), APO Grey

45RU Frame 605mm x 1100mm

The Clipsal range of frames are available in 19" and 24" models.

The frame's steel construction is designed to cope with heavy equipment including servers, network bridges and routers, all without buckling under the load.

DIMENSIONS

Catalogue Number	Height	Width	Depth	Max. Usable Depth
3106CAB45F110	2125mm	605mm	1100mm	984mm

CABLE ENTRIES

Top	4 of 50mm x 100mm knock outs 1 of 360mm x 360mm knock out
Bottom	1 of 410mm x 440mm knock out

ACCESSORIES AVAILABLE

Catalogue Number	Description
3106CT45U15	45RU Cable Tray 150mm
3106CT45U22	45RU Cable Tray 225mm
3106CT45U30	45RU Cable Tray 300mm
3106CAS60LD	Light Duty Castor Set
3106EK	Universal Earth Kit
3106FT260	2 Fan Tray
3106FT460	4 Fan Tray
3106JK	Joining Kit
3106SC (2U23 to 6U60)	Shelf Cantilever
3106SF (1U41 to 1U91)	Shelf Fixed
3106ST (1U41 to 2U71HD)	Shelf Telescopic
3106PH (6W1FP to 10W2FP)	Horizontal Power Rails
3106PV (10W2FP to 20W2FP)	Vertical Power Rails
3106TP60	Top Plain
3106TV60	Top Ventilated
3106AMD45	Door, Acrylic with Metal Surround
3106GD45	Door, Glass with Metal Surround
3106MD45	Door, Full Metal
3106VSP45U110	Side Panel Full Metal, Lockable
3106SPL	Side Panel Lock



3106CAB45F110

PRODUCT FEATURES

- Steel frame with plain top.
- Four vertical panel mounts adjustable through entire depth of frame.
- Leveling feet fitted as standard to all free standing cabinets.
- Ventilation slots in base.
- Comprehensive accessories available.

CATALOGUE NUMBER DESCRIPTION

3106CAB45F110 45RU Frame 605mm (W) x 1100mm (D), APO Grey

45RU Frame 605mm x 1200mm

The Clipsal range of frames are available in 19" and 24" models.

The frame's steel construction is designed to cope with heavy equipment including servers, network bridges and routers, all without buckling under the load.

DIMENSIONS

Catalogue Number	Height	Width	Depth	Max. Usable Depth
3106CAB45F120	2125mm	605mm	1200mm	1084mm

CABLE ENTRIES

Top	4 of 50mm x 100mm break outs 1 of 360mm x 360mm break out
Bottom	1 of 410mm x 440mm break out

ACCESSORIES AVAILABLE

Catalogue Number	Description
3106CT45U15	45RU Cable Tray 150mm
3106CT45U22	45RU Cable Tray 225mm
3106CT45U30	45RU Cable Tray 300mm
3106CAS60LD	Light Duty Castor Set
3106EK	Universal Earth Kit
3106FT260	2 Fan Tray
3106FT460	4 Fan Tray
3106JK	Joining Kit
3106SC (2U23 to 6U60)	Shelf Cantilever
3106SF (1U41 to 1U101)	Shelf Fixed
3106ST (1U41 to 2U71HD)	Shelf Telescopic
3106PH (6W1FP to 10W2FP)	Horizontal Power Rails
3106PV (10W2FP to 20W2FP)	Vertical Power Rails
3106TP60	Top Plain
3106TR60	Top Raised
3106TV60	Top Ventilated
3106AMD45	Door, Acrylic with Metal Surround
3106GD45	Door, Glass with Metal Surround
3106MD45	Door, Full Metal
3106SP45U120	Side Panel Full Metal, Lockable
3106SPL	Side Panel Lock



3106CAB45F120

PRODUCT FEATURES

- Steel frame with plain top.
- Four vertical panel mounts adjustable through entire depth of frame.
- Leveling feet fitted as standard to all free standing cabinets.
- Ventilation slots in base.
- Comprehensive accessories available.

CATALOGUE NUMBER DESCRIPTION

3106CAB45F120 45RU Frame 605mm (W) x 1200mm (D), APO Grey

45RU Frame 760mm x 800mm

The Clipsal range of frames are available in 19" and 24" models.

The frame's steel construction is designed to cope with heavy equipment including servers, network bridges and routers, all without buckling under the load.

DIMENSIONS

Catalogue Number	Height	Width	Depth	Max. Usable Depth
3106CAB45F824	2125mm	760mm	800mm	684mm

CABLE ENTRIES

Top	4 of 50mm x 100mm break outs 1 of 360mm x 360mm break out
Bottom	1 of 410mm x 440mm break out

ACCESSORIES AVAILABLE

Catalogue Number	Description
3106CT45U15	45RU Cable Tray 150mm
3106CT45U22	45RU Cable Tray 225mm
3106CT45U30	45RU Cable Tray 300mm
3106CAS76LD	Light Duty Castor Set
3106EK	Universal Earth Kit
3106FT260	2 Fan Tray
3106FT460	4 Fan Tray
3106JK	Joining Kit
3106SC (2U23 to 6U60)	Shelf Cantilever
3106SF (1U41 to 1U61)	Shelf Fixed
3106ST (1U41 to 2U61HD)	Shelf Telescopic
3106PH (6W1FP to 10W2FP)	Horizontal Power Rails
3106PV (10W2FP to 20W2FP)	Vertical Power Rails
3106TP60	Top Plain
3106TR60	Top Raised
3106TV60	Top Ventilated
3106AMD4524	Door, Acrylic with Metal Surround
3106MD4524	Door, Full Metal
3106SP45U80	Side Panel Full Metal, Lockable
3106SPL	Side Panel Lock



3106CAB45F824

PRODUCT FEATURES

- Steel frame with plain top.
- Four vertical panel mounts adjustable through entire depth of frame.
- Leveling feet fitted as standard to all free standing cabinets.
- Ventilation slots in base.
- Comprehensive accessories available.
- Includes reducing kits (19" to 24').

CATALOGUE NUMBER	DESCRIPTION
3106CAB45F824	45RU Frame 760mm (W) x 800mm (D), APO Grey

45RU Frame 760mm x 900mm

The Clipsal range of frames are available in 19" and 24" models.

The frame's steel construction is designed to cope with heavy equipment including servers, network bridges and routers, all without buckling under the load.

DIMENSIONS

Catalogue Number	Height	Width	Depth	Max. Usable Depth
3106CAB45F924	2125mm	760mm	900mm	784mm

CABLE ENTRIES

Top	4 of 50mm x 100mm break outs 1 of 360mm x 360mm break out
Bottom	1 of 410mm x 440mm break out

ACCESSORIES AVAILABLE

Catalogue Number	Description
3106CT45U15	45RU Cable Tray 150mm
3106CT45U22	45RU Cable Tray 225mm
3106CT45U30	45RU Cable Tray 300mm
3106CAS76LD	Light Duty Castor Set
3106EK	Universal Earth Kit
3106FT260	2 Fan Tray
3106FT460	4 Fan Tray
3106JK	Joining Kit
3106SC (2U23 to 6U60)	Shelf Cantilever
3106SF (1U41 to 1U71)	Shelf Fixed
3106ST (1U41 to 2U71HD)	Shelf Telescopic
3106PH (6W1FP to 10W2FP)	Horizontal Power Rails
3106PV (10W2FP to 20W2FP)	Vertical Power Rails
3106TP60	Top Plain
3106TR60	Top Raised
3106TV60	Top Ventilated
3106AMD4524	Door, Acrylic with Metal Surround
3106MD4524	Door, Full Metal
3106SP45U90	Side Panel Full Metal, Lockable
3106SPL	Side Panel Lock



3106CAB45F924

PRODUCT FEATURES

- Steel frame with plain top.
- Four vertical panel mounts adjustable through entire depth of frame.
- Leveling feet fitted as standard to all free standing cabinets.
- Ventilation slots in base.
- Comprehensive accessories available.
- Includes reducing kits (19" to 24").

CATALOGUE NUMBER DESCRIPTION

3106CAB45F924 45RU Frame 760mm (W) x 900mm (D), APO Grey

45RU Frame 760mm x 1000mm

The Clipsal range of frames are available in 19" and 24" models.

The frame's steel construction is designed to cope with heavy equipment including servers, network bridges and routers, all without buckling under the load.

DIMENSIONS

Catalogue Number	Height	Width	Depth	Max. Usable Depth
3106CAB45F1024	2125mm	760mm	1000mm	884mm

CABLE ENTRIES

Top	4 of by 50mm x 100mm break outs 1 of 360mm x 360mm break out
Bottom	1 of 410mm x 440mm break out

ACCESSORIES AVAILABLE

Catalogue Number	Description
3106CT45U15	45RU Cable Tray 150mm
3106CT45U22	45RU Cable Tray 225mm
3106CT45U30	45RU Cable Tray 300mm
3106CAS76LD	Light Duty Castor Set
3106EK	Universal Earth Kit
3106FT260	2 Fan Tray
3106FT460	4 Fan Tray
3106JK	Joining Kit
3106SC (2U23 to 6U60)	Shelf Cantilever
3106SF (1U41 to 1U81)	Shelf Fixed
3106ST (1U41 to 2U71HD)	Shelf Telescopic
3106PH (6W1FP to 10W2FP)	Horizontal Power Rails
3106PV (10W2FP to 20W2FP)	Vertical Power Rails
3106TP60	Top Plain
3106TR60	Top Raised
3106TV60	Top Ventilated
3106AMD4524	Door, Acrylic with Metal Surround
3106MD4524	Door, Full Metal
3106SP45U100	Side Panel Full Metal, Lockable
3106SPL	Side Panel Lock



3106CAB45F1024

PRODUCT FEATURES

- Steel frame with plain top.
- Four vertical panel mounts adjustable through entire depth of frame.
- Leveling feet fitted as standard to all free standing cabinets.
- Ventilation slots in base.
- Comprehensive accessories available.
- Includes reducing kits (19" to 24').

CATALOGUE NUMBER	DESCRIPTION
3106CAB45F1024	45RU Frame 760mm (W) x 1000mm (D), APO Grey

45RU Frame 760mm x 1100mm

The Clipsal range of frames are available in 19" and 24" models.

The frame's steel construction is designed to cope with heavy equipment including servers, network bridges and routers, all without buckling under the load.

DIMENSIONS

Catalogue Number	Height	Width	Depth	Max. Usable Depth
3106CAB45F1124	2125mm	760mm	1100mm	984mm

CABLE ENTRIES

Top	4 of 50mm x 100mm break outs 1 of 360mm x 360mm break out
Bottom	1 of 410mm x 440mm break out

ACCESSORIES AVAILABLE

Catalogue Number	Description
3106CT45U15	45RU Cable Tray 150mm
3106CT45U22	45RU Cable Tray 225mm
3106CT45U30	45RU Cable Tray 300mm
3106CAS76LD	Light Duty Castor Set
3106EK	Universal Earth Kit
3106FT260	2 Fan Tray
3106FT460	4 Fan Tray
3106JK	Joining Kit
3106SC (2U23 to 6U60)	Shelf Cantilever
3106SF (1U41 to 1U91)	Shelf Fixed
3106ST (1U41 to 2U71HD)	Shelf Telescopic
3106PH (6W1FP to 10W2FP)	Horizontal Power Rails
3106PV (10W2FP to 20W2FP)	Vertical Power Rails
3106TP60	Top Plain
3106TR60	Top Raised
3106TV60	Top Ventilated
3106AMD4524	Door, Acrylic with Metal Surround
3106MD4524	Door, Full Metal
3106VSP45U110	Side Panel Full Metal, Lockable
3106SPL	Side Panel Lock



3106CAB45F1124

PRODUCT FEATURES

- Steel frame with plain top.
- Four vertical panel mounts adjustable through entire depth of frame.
- Leveling feet fitted as standard to all free standing cabinets.
- Ventilation slots in base.
- Comprehensive accessories available.
- Includes reducing kits (19" to 24').

CATALOGUE NUMBER DESCRIPTION

3106CAB45F1124 45RU Frame 760mm (W) x 1100mm (D), APO Grey

45RU Frame 760mm x 1200mm

The Clipsal range of frames are available in 19" and 24" models.

The frame's steel construction is designed to cope with heavy equipment including servers, network bridges and routers, all without buckling under the load.

DIMENSIONS

Catalogue Number	Height	Width	Depth	Max. Usable Depth
3106CAB45F1224	2125mm	760mm	1200mm	1084mm

CABLE ENTRIES

Top	4 of 50mm x 100mm break outs 1 of 360mm x 360mm break out
Bottom	1 of 410mm x 440mm break out

ACCESSORIES AVAILABLE

Catalogue number	Description
3106CT45U15	45RU Cable Tray 150mm
3106CT45U22	45RU Cable Tray 225mm
3106CT45U30	45RU Cable Tray 300mm
3106CAS76LD	Light Duty Castor Set
3106EK	Universal Earth Kit
3106FT260	2 Fan Tray
3106FT460	4 Fan Tray
3106JK	Joining Kit
3106SC (2U23 to 6U60)	Shelf Cantilever
3106SF (1U41 to 1U101)	Shelf Fixed
3106ST (1U41 to 2U71HD)	Shelf Telescopic
3106PH (6W1FP to 10W2FP)	Horizontal Power Rails
3106PV (10W2FP to 20W2FP)	Vertical Power Rails
3106TP60	Top Plain
3106TR60	Top Raised
3106TV60	Top Ventilated
3106AMD4524	Door, Acrylic with Metal Surround
3106MD4524	Door, Full Metal
3106SP45U120	Side Panel Full Metal, Lockable
3106SPL	Side Panel Lock



3106CAB45F1224

PRODUCT FEATURES

- Steel frame with plain top.
- Four vertical panel mounts adjustable through entire depth of frame.
- Leveling feet fitted as standard to all free standing cabinets.
- Ventilation slots in base.
- Comprehensive accessories available.
- Includes reducing kits (19" to 24').

CATALOGUE NUMBER	DESCRIPTION
3106CAB45F1224	45RU Frame 760mm (W) x 1200mm (D), APO Grey

45RU Restricted Cabinet 605mm x 900mm

Clipsal Datacomms offer a comprehensive selection of Defence Class products, including a quality range of systems enclosures. Carrying full Defence Recognised Supplier approval, Clipsal Datacomms can cater to the individual requirements of the installer and end user.

All Clipsal Datacomms Defence Class Systems Enclosures comply with the stringent conditions of the Australian Defence Authority.

DIMENSIONS

Catalogue Number	Height	Width	Depth
3106D459060	2170mm	605mm	900mm

CABLE ENTRIES

Bottom	440mm x 700mm break out
--------	-------------------------

ACCESSORIES AVAILABLE

Catalogue Number	Description
3106CT45U15	Cable Tray 150mm
3106CT45U22	Cable Tray 225mm
3106CT45U30	Cable Tray 300mm
3106EK	Universal Earth Kit
3106SC (2U23 to 6U60)	Shelf Cantilever
3106S (1U41 to 1U71)	Shelf Fixed
3106ST (1U41 to 2U71HD)	Shelf Telescopic
3106PV (10W2FP to 20W2FP)	Vertical Power Rails
3106PH (6W1FP to 10W2FP)	Horizontal Power Rails
3106JK	Joining Kit



3106D459060

PRODUCT FEATURES

- Metal framed perspex door.
- Rear metal door.
- Tamper resistant nuts.
- Front and rear mounting rails.
- Internally fixed side panels.
- Three point locking – front and rear.
- Four fan, fan tray (tamper proof).

CATALOGUE NUMBER DESCRIPTION

3106D459060 45RU Restricted Complete Cabinet, 605mm (W) x 900mm (D)

45RU Restricted Cabinet 760mm x 800mm

Clipsal Datacomms offer a comprehensive selection of Defence Class products, including a quality range of systems enclosures. Carrying full Defence Recognised Supplier approval, Clipsal Datacomms can cater to the individual requirements of the installer and end user.

All Clipsal Datacomms Defence Class Systems Enclosures comply with the stringent conditions of the Australian Defence Authority.

DIMENSIONS

Catalogue Number	Height	Width	Depth
3106D458076	2170mm	760mm	800mm

CABLE ENTRIES

Top	6 of 50mm x 170mm break outs
Bottom	6 of 50mm x 170mm break outs

ACCESSORIES AVAILABLE

Catalogue Number	Description
3106CT45U15	Cable Tray 150mm
3106CT45U22	Cable Tray 225mm
3106CT45U30	Cable Tray 300mm
3106EK	Universal Earth Kit
3106SC (2U23 to 6U60)	Shelf Cantilever
3106SF (1U45 to 1U61)	Shelf Fixed
3106ST (1U41 to 2U61HD)	Shelf Telescopic
3106PV (10W2FP to 20W2FP)	Vertical Power Rails
3106PH (6W1FP to 10W2FP)	Horizontal Power Rails
3106JK	Joining Kit



3106D458076

PRODUCT FEATURES

- Metal framed perspex door.
- Rear metal door.
- Tamper resistant nuts.
- Front and rear mounting rails.
- Internally fixed side panels.
- Three point locking – front and rear.
- 24" to 19" reducing brackets.
- Four fan, fan tray (tamper proof).

CATALOGUE NUMBER DESCRIPTION

3106D458076 445RU Restricted Complete Cabinet, 760mm (W) x 800mm (D)

39RU Class 'C' Cabinet 600mm x 800mm

Clipsal Datacomms offer a comprehensive selection of Defence Class products, including a quality range of systems enclosures. Carrying full Defence Recognised Supplier approval, Clipsal Datacomms can cater to the individual requirements of the installer and end user.

All Clipsal Datacomms Defence Class Systems Enclosures comply with the stringent conditions of the Australian Defence Authority.

DIMENSIONS

Catalogue Number	Height	Width	Depth
3106C398060	1904mm	600mm	800mm

CABLE ENTRIES

Top	4 of 200mm x 50mm break outs
Bottom Knockout	Full access cable plinth with 4 100mm x 50mm break outs

ACCESSORIES AVAILABLE

Catalogue Number	Description
3106CT39U15	Cable Tray 150mm
3106CT39U22	Cable Tray 225mm
3106CT39U30	Cable Tray 300mm
3106EK	Universal Earth Kit
3106SC (2U23 to 6U60)	Shelf Cantilever
3106SF (1U41 to 1U61)	Shelf Fixed
3106ST (1U41 to 2U61HD)	Shelf Telescopic
3106PV (10W2FP to 13W2FP)	Vertical Power Rails
3106PH (6W1FP to 10W2FP)	Horizontal Power Rails
3106JK	Joining Kit



3106C398060

PRODUCT FEATURES

- ASIO approved bi-lock.
- Metal framed perspex door.
- Rear metal door.
- Tamper resistant nuts.
- Front and rear mounting rails.
- Internally fixed side panels.
- Four fan, fan tray (tamper proof).

CATALOGUE NUMBER DESCRIPTION

3106C398060 39RU Complete Class 'C' Cabinet, 600mm (W) x 800mm (D)

39RU Class 'C' Cabinet 600mm x 900mm

Clipsal Datacomms offer a comprehensive selection of Defence Class products, including a quality range of systems enclosures. Carrying full Defence Recognised Supplier approval, Clipsal Datacomms can cater to the individual requirements of the installer and end user.

All Clipsal Datacomms Defence Class Systems Enclosures comply with the stringent conditions of the Australian Defence Authority.

DIMENSIONS

Catalogue Number	Height	Width	Depth
3106C399060	1904mm	600mm	900mm

CABLE ENTRIES

Top	4 of 200mm x 50mm break outs
Bottom Knockout	Full access cable plinth with 4 100mm x 50mm break outs

ACCESSORIES AVAILABLE

Catalogue Number	Description
3106CT39U15	Cable Tray 150mm
3106CT39U22	Cable Tray 225mm
3106CT39U30	Cable Tray 300mm
3106EK	Universal Earth Kit
3106SC (2U23 to 6U60)	Shelf Cantilever
3106SF (1U41 to 1U71)	Shelf Fixed
3106ST (1U41 to 2U71HD)	Shelf Telescopic
3106PV (10W2FP to 20W2FP)	Vertical Power Rails
3106PH (6W1FP to 10W2FP)	Horizontal Power Rails
3106JK	Joining Kit



3106C399060

PRODUCT FEATURES

- ASIO approved bi-lock.
- Metal framed perspex door.
- Rear metal door.
- Tamper resistant nuts.
- Front and rear mounting rails.
- Internally fixed side panels.
- Four fan, fan tray (tamper proof).

CATALOGUE NUMBER DESCRIPTION

3106C399060 39RU Complete Class 'C' Cabinet, 600mm (W) x 900mm (D)

45RU Class 'C' Cabinet 600mm x 800mm

Clipsal Datacomms offer a comprehensive selection of Defence Class products, including a quality range of systems enclosures. Carrying full Defence Recognised Supplier approval, Clipsal Datacomms can cater to the individual requirements of the installer and end user.

All Clipsal Datacomms Defence Class Systems Enclosures comply with the stringent conditions of the Australian Defence Authority.

DIMENSIONS

Catalogue Number	Height	Width	Depth
3106C458060	2170mm	600mm	800mm

CABLE ENTRIES

Top	4 of 200mm x 50mm break outs
Bottom Knockout	Full access cable plinth with 4 100mm x 50mm break outs

ACCESSORIES AVAILABLE

Catalogue Number	Description
3106CT45U15	Cable Tray 150mm
3106CT45U22	Cable Tray 225mm
3106CT45U30	Cable Tray 300mm
3106EK	Universal Earth Kit
3106SC (2U23 to 6U60)	Shelf Cantilever
3106SF (1U41 to 1U61)	Shelf Fixed
3106ST (1U41 to 2U61HD)	Shelf Telescopic
3106PV (10W2FP to 20W2FP)	Vertical Power Rails
3106PH (6W1FP to 10W2FP)	Horizontal Power Rails
3106JK	Joining Kit



3106C458060

PRODUCT FEATURES

- ASIO approved bi-lock.
- Metal framed perspex door.
- Rear metal door.
- Tamper resistant nuts.
- Front and rear mounting rails.
- Internally fixed side panels.
- Four fan, fan tray (tamper proof).

CATALOGUE NUMBER DESCRIPTION

3106C458060 45RU Complete Class 'C' Cabinet, 600mm (W) x 800mm (D)

45RU Class 'C' Cabinet 600mm x 900mm

Clipsal Datacomms offer a comprehensive selection of Defence Class products, including a quality range of systems enclosures. Carrying full Defence Recognised Supplier approval, Clipsal Datacomms can cater to the individual requirements of the installer and end user.

All Clipsal Datacomms Defence Class Systems Enclosures comply with the stringent conditions of the Australian Defence Authority.

DIMENSIONS

Catalogue Number	Height	Width	Depth
3106C459060	2170mm	600mm	900mm

CABLE ENTRIES

Top	4 of 200mm x 50mm break outs
Bottom Knockout	Full access cable plinth with 4 100mm x 50mm break outs

ACCESSORIES AVAILABLE

Catalogue Number	Description
3106CT45U15	Cable Tray 150mm
3106CT45U22	Cable Tray 225mm
3106CT45U30	Cable Tray 300mm
3106EK	Universal Earth Kit
3106SC (2U23 to 6U60)	Shelf Cantilever
3106SF (1U41 to 1U71)	Shelf Fixed
3106ST (1U41 to 2U71HD)	Shelf Telescopic
3106PV (10W2FP to 20W2FP)	Vertical Power Rails
3106PH (6W1FP to 10W2FP)	Horizontal Power Rails
3106JK	Joining Kit



3106C459060

PRODUCT FEATURES

- ASIO approved bi-lock.
- Metal framed perspex door.
- Rear metal door.
- Tamper resistant nuts.
- Front and rear mounting rails.
- Internally fixed side panels.
- Four fan, fan tray (tamper proof).

CATALOGUE NUMBER DESCRIPTION

3106C459060 45RU Complete Class 'C' Cabinet, 600mm (W) x 900mm (D)

45RU Class 'C' Cabinet 600mm x 1000mm

Clipsal Datacomms offer a comprehensive selection of Defence Class products, including a quality range of systems enclosures. Carrying full Defence Recognised Supplier approval, Clipsal Datacomms can cater to the individual requirements of the installer and end user.

All Clipsal Datacomms Defence Class Systems Enclosures comply with the stringent conditions of the Australian Defence Authority.

DIMENSIONS

Catalogue Number	Height	Width	Depth
3106C4510060	2170mm	600mm	1000mm

CABLE ENTRIES

Top	4 of 200mm x 50mm break outs
Bottom Knockout	Full access cable plinth with 4 100mm x 50mm break outs

ACCESSORIES AVAILABLE

Catalogue Number	Description
3106CT45U15	Cable Tray 150mm
3106CT45U22	Cable Tray 225mm
3106CT45U30	Cable Tray 300mm
3106EK	Universal Earth Kit
3106SC (2U23 to 6U60)	Shelf Cantilever
3106SF (1U41 to 1U81)	Shelf Fixed
3106ST (1U41 to 2U71HD)	Shelf Telescopic
3106PV (10W2FP to 20W2FP)	Vertical Power Rails
3106PH (6W1FP to 10W2FP)	Horizontal Power Rails
3106JK	Joining Kit



3106C4510060

PRODUCT FEATURES

- ASIO approved bi-lock.
- Metal framed perspex door.
- Rear metal door.
- Tamper resistant nuts.
- Front and rear mounting rails.
- Internally fixed side panels.
- Four fan, fan tray (tamper proof).

CATALOGUE NUMBER DESCRIPTION

3106C4510060 45RU Complete Class 'C' Cabinet, 600mm (W) x 1000mm (D)

45RU Class 'C' Cabinet 760mm x 800mm

Clipsal Datacomms offer a comprehensive selection of Defence Class products, including a quality range of systems enclosures. Carrying full Defence Recognised Supplier approval, Clipsal Datacomms can cater to the individual requirements of the installer and end user.

All Clipsal Datacomms Defence Class Systems Enclosures comply with the stringent conditions of the Australian Defence Authority.

DIMENSIONS

Catalogue Number	Height	Width	Depth
3106C458076	2170mm	760mm	800mm

CABLE ENTRIES

Top	4 of 200mm x 50mm break outs
Bottom Knockout	Full access cable plinth with 4 100mm x 50mm Break Outs

ACCESSORIES AVAILABLE

Catalogue Number	Description
3106CT45U15	Cable Tray 150mm
3106CT45U22	Cable Tray 225mm
3106CT45U30	Cable Tray 300mm
3106EK	Universal Earth Kit
3106SC (2U23 to 6U60)	Shelf Cantilever
3106SF (1U41 to 1U61)	Shelf Fixed
3106ST (1U41 to 2U61HD)	Shelf Telescopic
3106PV (10W2FP to 20W2FP)	Vertical Power Rails
3106PH (6W1FP to 10W2FP)	Horizontal Power Rails
3106JK	Joining Kit



3106C458076

PRODUCT FEATURES

- ASIO approved bi-lock.
- Metal framed perspex door.
- Rear metal door.
- Tamper resistant nuts.
- Front and rear mounting rails.
- Internally fixed side panels.
- 24" to 19" reducing brackets.
- Four fan, fan tray (tamper proof).

CATALOGUE NUMBER	DESCRIPTION
3106C458076	45RU Complete Class 'C' Cabinet, 760mm (W) x 800mm (D)

45RU Class 'C' Cabinet 760mm x 900mm

Clipsal Datacomms offer a comprehensive selection of Defence Class products, including a quality range of systems enclosures. Carrying full Defence Recognised Supplier approval, Clipsal Datacomms can cater to the individual requirements of the installer and end user.

All Clipsal Datacomms Defence Class Systems Enclosures comply with the stringent conditions of the Australian Defence Authority.

DIMENSIONS

Catalogue Number	Height	Width	Depth
3106C459076	2170mm	760mm	900mm

CABLE ENTRIES

Top	4 of 200mm x 50mm break outs
Bottom Knockout	Full access cable plinth with 4 100mm x 50mm break outs

ACCESSORIES AVAILABLE

Catalogue Number	Description
3106CT45U15	Cable Tray 150mm
3106CT45U22	Cable Tray 225mm
3106CT45U30	Cable Tray 300mm
3106EK	Universal Earth Kit
3106SC (2U23 to 6U60)	Shelf Cantilever
3106SF (1U41 to 1U71)	Shelf Fixed
3106ST (1U41 to 2U71HD)	Shelf Telescopic
3106PV (10W2FP to 20W2FP)	Vertical Power Rails
3106PH (6W1FP to 10W2FP)	Horizontal Power Rails
3106JK	Joining Kit



3106C459076

PRODUCT FEATURES

- ASIO approved bi-lock.
- Metal framed perspex door.
- Rear metal door.
- Tamper resistant nuts.
- Front and rear mounting rails.
- Internally fixed side panels.
- 24" to 19" reducing brackets.
- Four fan, fan tray (tamper proof).

CATALOGUE NUMBER DESCRIPTION

3106C459076 45RU Complete Class 'C' Cabinet, 760mm (W) x 900mm (D)

6RU Clipsal titanium® Wall Cabinet 350mm Deep

The Clipsal titanium® range of wall mounted enclosures offer a myriad of innovative features, designed for ease of installation and maintenance. The contemporary aesthetics have been styled to enhance the interior décor of modern commercial office environments and residential dwellings.

DIMENSIONS

Catalogue Number	Height	Width	Depth
3106WTC6U35	327mm	572mm	507mm*

*Includes 120mm rear frame.

ACCESSORIES AVAILABLE

Catalogue Number	Description
3106PH (6W1FP to 10W2FP)	Horizontal Power Rails
3106SC (2U23 to 2U28)	Shelf Cantilever
3106WTC6URR	6RU Rear Rail, 2pk

DOOR LOCK KEY NUMBER

92268



3106WTC6U35

PRODUCT FEATURES

- Separate rear hinged frame with rack units.
- Knockouts in rear frame for seamless duct connection.
- Hinged cabinet mounting onto frame or wall.
- Internal latch for cabinet hinging (left or right sides).
- Multiple mounting widths to suit different stud wall requirements.
- Choice of cabinet hinging on either side (left or right).
- Choice of door hinging on either side (left or right).
- Contemporary aesthetics.
- 500mm deep cabinets can accommodate fibre enclosures.
- 2 x shelf mount rails.

CUSTOMER BENEFITS

- Hinged frame allows for ease of installation and maintenance.
- Rack units on rear frame allow for additional equipment.
- Internal latch provides effortless access to the rear of the cabinet.
- Simple and flawless connection to ducting spirit level ensures parallel, horizontal mounting.
- Hinging and locking options to suit customer preferences.
- Superior styling to enhance the latest office décors.

CATALOGUE NUMBER	DESCRIPTION
3106WTC6U35	6RU Wall Cabinet 350mm Deep

6RU Clipsal titanium® Wall Cabinet 500mm Deep

The Clipsal titanium® range of wall mounted enclosures offer a myriad of innovative features, designed for ease of installation and maintenance. The contemporary aesthetics have been styled to enhance the interior décor of modern commercial office environments and residential dwellings.

DIMENSIONS

Catalogue Number	Height	Width	Depth
3106WTC6U50	327mm	572mm	657mm*

*Includes 120mm rear frame.

ACCESSORIES AVAILABLE

Catalogue Number	Description
3106PH (6W1FP to 10W2FP)	Horizontal Power Rails
3106SC (2U23 to 2U28)	Shelf Cantilever
3106WTC6URR	6RU Rear Rail, 2pk

DOOR LOCK KEY NUMBER

92268



3106WTC6U50

PRODUCT FEATURES

- Separate rear hinged frame with rack units.
- Knockouts in rear frame for seamless duct connection.
- Hinged cabinet mounting onto frame or wall.
- Internal latch for cabinet hinging (left or right sides).
- Multiple mounting widths to suit different stud wall requirements.
- Choice of cabinet hinging on either side (left or right).
- Choice of door hinging on either side (left or right).
- Contemporary aesthetics.
- 500mm deep cabinets can accommodate fibre enclosures.
- 2 x shelf mount rails.

CUSTOMER BENEFITS

- Hinged frame allows for ease of installation and maintenance.
- Rack units on rear frame allow for additional equipment.
- Internal latch provides effortless access to the rear of the cabinet.
- Simple and flawless connection to ducting spirit level ensures parallel, horizontal mounting.
- Hinging and locking options to suit customer preferences.
- Superior styling to enhance the latest office décors.

CATALOGUE NUMBER	DESCRIPTION
3106WTC6U50	6RU Wall Cabinet 500mm Deep

12RU Clipsal titanium® Wall Cabinet 350mm Deep

The Clipsal titanium® range of wall mounted enclosures offer a myriad of innovative features, designed for ease of installation and maintenance. The contemporary aesthetics have been styled to enhance the interior décor of modern commercial office environments and residential dwellings.

DIMENSIONS

Catalogue Number	Height	Width	Depth
3106WTC12U35	588mm	572mm	507mm*

*Includes 120mm rear frame.

ACCESSORIES AVAILABLE

Catalogue Number	Description
3106PH (6W1FP to 10W2FP)	Horizontal Power Rails
3106SC (2U23 to 2U28)	Shelf Cantilever
3106WTC12URR	12RU Rear Rail, 2pk
3106CT12U15	12RU Cable Tray 150mm
3106CT12U30	12RU Cable Tray 300mm

DOOR LOCK KEY NUMBER

92268



3106WTC12U35

PRODUCT FEATURES

- Separate rear hinged frame with rack units.
- Knockouts in rear frame for seamless duct connection.
- Hinged cabinet mounting onto frame or wall.
- Internal latch for cabinet hinging (left or right sides).
- Multiple mounting widths to suit different stud wall requirements.
- Choice of cabinet hinging on either side (left or right).
- Choice of door hinging on either side (left or right).
- Contemporary aesthetics.
- 500mm deep cabinets can accommodate fibre enclosures.
- 2 x shelf mount rails.

CUSTOMER BENEFITS

- Hinged frame allows for ease of installation and maintenance.
- Rack units on rear frame allow for additional equipment.
- Internal latch provides effortless access to the rear of the cabinet.
- Simple and flawless connection to ducting spirit level ensures parallel, horizontal mounting.
- Hinging and locking options to suit customer preferences.
- Superior styling to enhance the latest office décors.

CATALOGUE NUMBER	DESCRIPTION
3106WTC12U35	12RU Wall Cabinet 350mm Deep

12RU Clipsal titanium® Wall Cabinet 500mm Deep

The Clipsal titanium® range of wall mounted enclosures offer a myriad of innovative features, designed for ease of installation and maintenance. The contemporary aesthetics have been styled to enhance the interior décor of modern commercial office environments and residential dwellings.

DIMENSIONS

Catalogue Number	Height	Width	Depth
3106WTC12U50	588mm	572mm	657mm*

*Includes 120mm rear frame.

ACCESSORIES AVAILABLE

Catalogue Number	Description
3106PH (6W1FP to 10W2FP)	Horizontal Power Rails
3106SC (2U23 to 2U28)	Shelf Cantilever
3106WTC12URR	12RU Rear Rail, 2pk
3106CT12U15	12RU Cable Tray 150mm
3106CT12U30	12RU Cable Tray 300mm

DOOR LOCK KEY NUMBER

92268



3106WTC12U50

PRODUCT FEATURES

- Separate rear hinged frame with rack units.
- Knockouts in rear frame for seamless duct connection.
- Hinged cabinet mounting onto frame or wall.
- Internal latch for cabinet hinging (left or right sides).
- Multiple mounting widths to suit different stud wall requirements.
- Choice of cabinet hinging on either side (left or right).
- Choice of door hinging on either side (left or right).
- Contemporary aesthetics.
- 500mm deep cabinets can accommodate fibre enclosures.
- 2 x shelf mount rails.

CUSTOMER BENEFITS

- Hinged frame allows for ease of installation and maintenance.
- Rack units on rear frame allow for additional equipment.
- Internal latch provides effortless access to the rear of the cabinet.
- Simple and flawless connection to ducting spirit level ensures parallel, horizontal mounting.
- Hinging and locking options to suit customer preferences.
- Superior styling to enhance the latest office décors.

CATALOGUE NUMBER	DESCRIPTION
3106WTC12U50	12RU Wall Cabinet 500mm Deep

18RU Clipsal titanium® Wall Cabinet 500mm Deep

The Clipsal titanium® range of wall mounted enclosures offer a myriad of innovative features, designed for ease of installation and maintenance. The contemporary aesthetics have been styled to enhance the interior décor of modern commercial office environments and residential dwellings.

DIMENSIONS

Catalogue Number	Height	Width	Depth
3106WTC18U50	855mm	572mm	657mm*

*Includes 120mm rear frame.

ACCESSORIES AVAILABLE

Catalogue Number	Description
3106PH (6W1FP to 10W2FP)	Horizontal Power Rails
3106SC (2U23 to 3U30)	Shelf Cantilever
3106WTC18URR	18RU Rear Rail, 2pk
3106CT18U15	18RU Cable Tray 150mm
3106CT18U22	18RU Cable Tray 225mm
3106CT18U30	18RU Cable Tray 300mm

DOOR LOCK KEY NUMBER

92268



3106WTC18U50

PRODUCT FEATURES

- Separate rear hinged frame with rack units.
- Knockouts in rear frame for seamless duct connection.
- Hinged cabinet mounting onto frame or wall.
- Internal latch for cabinet hinging (left or right sides).
- Multiple mounting widths to suit different stud wall requirements.
- Choice of cabinet hinging on either side (left or right).
- Choice of door hinging on either side (left or right).
- Contemporary aesthetics.
- 500mm deep cabinets can accommodate fibre enclosures.
- 2 x shelf mount rails.

CUSTOMER BENEFITS

- Hinged frame allows for ease of installation and maintenance.
- Rack units on rear frame allow for additional equipment.
- Internal latch provides effortless access to the rear of the cabinet.
- Simple and flawless connection to ducting spirit level ensures parallel, horizontal mounting.
- Hinging and locking options to suit customer preferences.
- Superior styling to enhance the latest office décors.

CATALOGUE NUMBER	DESCRIPTION
3106WTC18U50	18RU Wall Cabinet 500mm Deep

6RU Wall Cabinet 350mm Deep

The Clipsal titanium® range of wall mounted enclosures are available in varying heights and depths to meet your installation requirements.

Combined with a comprehensive range of accessories the Clipsal wall cabinet range offers a great solution.

DIMENSIONS

Catalogue Number	Height	Width	Depth
3106WC6U35	350mm	600mm	350mm
3106HWC6U35	350mm	600mm	410mm
3106HWM6U35	350mm	600mm	410mm

ACCESSORIES AVAILABLE

Catalogue Number	Description
3106PH (6W1FP to 10W2FP)	Horizontal Power Rails
3106SC (2U23 to 2U28)	Shelf Cantilever
3106VPMW6U	6RU Side Rail, 1pk
3106HWMK6U	Hinged Wall Mount Kit

DOOR LOCK KEY NUMBER

CL003

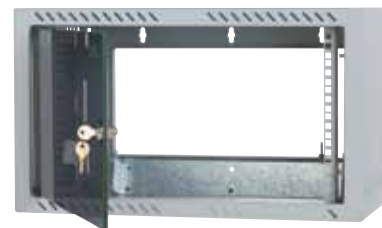

3106WC6U35

PRODUCT FEATURES

- Welded steel enclosure.
- Mounting support bracket.
- Lockable lift off acrylic front door.
- Door hinged left or right.
- 2 x shelf mounting rails.
- Spirit level provided.

CATALOGUE NUMBER	DESCRIPTION
3106WC6U35	6RU Wall Cabinet 350mm Deep, APO Grey
3106HWC6U35	6RU Wall Cabinet with Hinge 410mm Deep, APO Grey
3106HWM6U35	6RU Wall Cabinet with Hinge and Metal Frame Door 410mm Deep, APO Grey

6RU Wall Cabinet 450mm Deep

The Clipsal titanium® range of wall mounted enclosures are available in varying heights and depths to meet your installation requirements.

Combined with a comprehensive range of accessories the Clipsal wall cabinet range offers a great solution.

DIMENSIONS

Catalogue Number	Height	Width	Depth
3106WC6U45	350mm	600mm	450mm
3106HWM6U45	350mm	600mm	510mm

ACCESSORIES AVAILABLE

Catalogue Number	Description
3106PH (6W1FP to 10W2FP)	Horizontal Power Rails
3106SC (2U23 to 2U28)	Shelf Cantilever
3106VPMW6U	6RU Side Rail, 1pk
3106HWMK6U	Hinged Wall Mount Kit

DOOR LOCK KEY NUMBER

CL003



3106WC6U45

PRODUCT FEATURES

- Welded steel enclosure.
- Mounting support bracket.
- Lockable lift off acrylic front door.
- Door hinged left or right.
- 2 x shelf mounting rails.
- Spirit level provided.

CATALOGUE NUMBER	DESCRIPTION
3106WC6U45	6RU Wall Cabinet 450mm Deep, APO Grey
3106HWM6U45	6RU Wall Cabinet with Hinge and Metal Frame Door 510mm Deep, APO Grey

12RU Wall Cabinet 350mm Deep

The Clipsal titanium® range of wall mounted enclosures are available in varying heights and depths to meet your installation requirements.

Combined with a comprehensive range of accessories the Clipsal wall cabinet range offers a great solution.

DIMENSIONS

Catalogue Number	Height	Width	Depth
3106WC12U35	617mm	600mm	350mm
3106HWC12U35	617mm	600mm	410mm
3106HWM12U35	617mm	600mm	410mm

ACCESSORIES AVAILABLE

Catalogue Number	Description
3106PH (6W1FP to 10W2FP)	Horizontal Power Rails
3106SC (2U23 to 2U28)	Shelf Cantilever
3106VPMW12U	12RU Side Rail, 1 Rail
3106HWMK12U	Hinged Wall Mount Kit
3106SWF12U	Swing Frame Internal
3106CT12U15	12RU Cable Tray 150mm
3106CT12U30	12RU Cable Tray 300mm

DOOR LOCK KEY NUMBER

CL003



3106WC12U35

PRODUCT FEATURES

- Welded steel enclosure.
- Mounting support bracket.
- Lockable lift off acrylic front door.
- Door hinged left or right.
- 2 x shelf mounting rails.
- Spirit level provided.

CATALOGUE NUMBER	DESCRIPTION
3106WC12U35	12RU Wall Cabinet 350mm Deep, APO Grey
3106HWC12U35	12RU Hinged Wall Cabinet 410mm Deep, APO Grey
3106HWM12U35	12RU Hinged Wall Frame 410mm Deep, APO Grey

12RU Wall Cabinet 500mm Deep

The Clipsal titanium® range of wall mounted enclosures are available in varying heights and depths to meet your installation requirements.

Combined with a comprehensive range of accessories the Clipsal wall cabinet range offers a great solution.

DIMENSIONS

Catalogue Number	Height	Width	Depth
3106WC12U50	617mm	600mm	500mm
3106HWC12U50	617mm	600mm	570mm
3106HWM12U50	617mm	600mm	570mm

ACCESSORIES AVAILABLE

Catalogue Number	Description
3106PH (6W1FP to 10W2FP)	Horizontal Power Rails
3106SC (2U23 to 3U30)	Shelf Cantilever
3106SF (1U41)	Shelf Front Fixed
3106ST (1U41)	Shelf Telescopic
3106HWMK12U	Hinged Wall Mount Kit
3106SWF12U	Swing Frame Internal
3106CT12U15	12RU Cable Tray 150mm
3106CT12U30	12RU Cable Tray 300mm
3106VPMW12U	12RU Side Rail, 1 Rail

DOOR LOCK KEY NUMBER

CL003



3106WC12U50

PRODUCT FEATURES

- Welded steel enclosure.
- Mounting support bracket.
- Lockable lift off acrylic front door.
- Door hinged left or right.
- 2 x shelf mounting rails.
- Spirit level provided.

CATALOGUE NUMBER	DESCRIPTION
3106WC12U50	12RU Wall Cabinet 500mm Deep, APO Grey
3106HWC12U50	12RU Hinged Wall Cabinet 570mm Deep, APO Grey
3106HWM12U50	12RU Hinged Wall Frame 570mm Deep, APO Grey

18RU Wall Cabinet 350mm Deep

The Clipsal titanium® range of wall mounted enclosures are available in varying heights and depths to meet your installation requirements.

Combined with a comprehensive range of accessories the Clipsal wall cabinet range offers a great solution.

DIMENSIONS

Catalogue Number	Height	Width	Depth
3106WC18U35	884mm	600mm	350mm
3106HWM18U35	884mm	600mm	410mm

ACCESSORIES AVAILABLE

Catalogue Number	Description
3106PH (6W1FP TO 10W2FP)	Horizontal Power Rails
3106SC (2U23 TO 2U28)	Shelf Cantilever
3106HWMK18U	Hinged Wall Mount Kit
3106CT18U15	18RU Cable Tray 150mm
3106CT18U22	18RU Cable Tray 225mm
3106CT18U30	18RU Cable Tray 300mm
3106VPMW18U	18RU Side Rail, 1 Rail

DOOR LOCK KEY NUMBER

CL003



3106WC18U35

PRODUCT FEATURES

- Welded steel enclosure.
- Mounting support bracket.
- Lockable lift off acrylic front door.
- Door hinged left or right.
- 2 x shelf mounting rails.
- Spirit level provided.

CATALOGUE NUMBER	DESCRIPTION
3106WC18U35	18RU Wall Cabinet 350mm Deep, APO Grey
3106HWM18U35	18RU Hinged Wall Frame 410mm Deep, APO Grey

18RU Wall Cabinet 500mm Deep

The Clipsal titanium® range of wall mounted enclosures are available in varying heights and depths to meet your installation requirements.

Combined with a comprehensive range of accessories the Clipsal wall cabinet range offers a great solution.

DIMENSIONS

Catalogue Number	Height	Width	Depth
3106WC18U50	884mm	600mm	500mm
3106HWM18U50	884mm	600mm	570mm

ACCESSORIES AVAILABLE

Catalogue Number	Description
3106PH (6W1FP to 10W2FP)	Horizontal Power Rails
3106SC (2U23 to 3U30)	Shelf Cantilever
3106SF (1U41)	Shelf Front Fixed
3106ST (1U41)	Shelf Telescopic
3106HWMK18U	Hinged Wall Mount Kit
3106CT18U15	18RU Cable Tray 150mm
3106CT18U22	18RU Cable Tray 225mm
3106CT18U30	18RU Cable Tray 300mm
3106VPMW18U	18RU Side Rail

DOOR LOCK KEY NUMBER

CL003



3106WC18U50

PRODUCT FEATURES

- Welded steel enclosure.
- Mounting support bracket.
- Lockable lift off acrylic front door.
- Door hinged left or right.
- 2 x shelf mounting rails.
- Spirit level provided

CATALOGUE NUMBER	DESCRIPTION
3106WC18U50	18RU Wall Cabinet 500mm Deep, APO Grey
3106HWM18U50	18RU Hinged Wall Frame 570mm Deep, APO Grey

Hinged Wall Frames

2RU HINGED WALL FRAME 125mm & 200mm DEEP

DIMENSIONS

Catalogue Number	Height	Width	Depth
3106WFH2U12,BK	2RU	490mm	125mm
3106WFH2U20,BK	2RU	490mm	200mm

ACCESSORIES AVAILABLE

CATALOGUE NUMBER	DESCRIPTION
3106COV12	Top and Bottom Cover 2RU Hinged Wall Frame 125mm
3106COV20	Top and Bottom Cover 2RU Hinged Wall Frame 200mm
3106BP01	1RU 19" Blank Panel, Black

4RU HINGED WALL FRAME 125mm & 200mm DEEP

DIMENSIONS

Catalogue Number	Height	Width	Depth
3106WFH4U12,BK	4RU	490mm	125mm
3106WFH4U20,BK	4RU	490mm	200mm

ACCESSORIES AVAILABLE

Catalogue Number	Description
3106COV12	Top and Bottom Cover 2RU Hinged Wall Frame 125mm
3106COV20	Top and Bottom Cover 2RU Hinged Wall Frame 200mm
3106BP01	1RU 19" Blank Panel, Black
3106BP02	2RU 19" Blank Panel, Black
3106BP03	3RU 19" Blank Panel, Black

6RU HINGED WALL FRAME 300MM DEEP

DIMENSIONS

Catalogue Number	Height	Width	Depth
3106WFH6U30,BK	6RU	490mm	300mm

ACCESSORIES AVAILABLE

Catalogue Number	Description
3106COV30	Top and Bottom Cover
3106BP01	1RU 19" Blank Panel, Black
3106BP02	2RU 19" Blank Panel, Black
3106BP03	3RU 19" Blank Panel, Black



3106WFH4U12,BK



3106WFH4U20,BK



3106WFH6U30,BK



3106COV12,BK



3106COV20,BK

CATALOGUE NUMBER	DESCRIPTION
3106WFH2U12,BK	2RU Hinged Wall Frame 125mm Deep, Black
3106WFH2U20,BK	2RU Hinged Wall Frame 200mm Deep, Black
3106WFH4U12,BK	4RU Hinged Wall Frame 125mm Deep, Black
3106WFH4U20,BK	4RU Hinged Wall Frame 200mm Deep, Black
3106WFH6U30,BK	6RU Hinged Wall Frame 300mm Deep, Black

19" Lab Racks

DIMENSIONS

Catalogue Number	Height	Width	RU
3106LR24	1182mm	500mm	29
3106LR39	1849mm	500mm	39
3106LR45	2116mm	500mm	45

ACCESSORIES AVAILABLE

Catalogue Number	Description
3106SC (2U23 to 6U60)	Shelf Cantilever
3106PH (6W1FP to 10W2FP)	Horizontal Power Rails



3106LR24

CATALOGUE NUMBER	DESCRIPTION
3106LR24	24RU Lab Rack 19"
3106LR39	39RU Lab Rack 19"
3106LR45	45RU Lab Rack 19"

Cabinet Accessories

CABLE MANAGEMENT TRAYS

The range of Clipsal cable trays come in sizes to suit all Clipsal cabinets and frames.

The varying width of the cable trays allows the installer to use the size that best accommodates the amount of cable being used in the cabinet or frame.



3106CT12U15

CATALOGUE NUMBER	DESCRIPTION
3106CT12U15	12RU Cable Tray, 150mm
3106CT12U30	12RU Cable Tray, 300mm
3106CT18U15	18RU Cable Tray, 150mm
3106CT18U22	18RU Cable Tray, 225mm
3106CT18U30	18RU Cable Tray, 300mm
3106CT27U15	27RU Cable Tray, 150mm
3106CT27U22	27RU Cable Tray, 225mm
3106CT39U15	39RU Cable Tray, 150mm
3106CT39U22	39RU Cable Tray, 225mm
3106CT45U15	45RU Cable Tray, 150mm
3106CT45U22	45RU Cable Tray, 225mm
3106CT45U30	45RU Cable Tray, 300mm

CAGE NUTS



3106CN

CATALOGUE NUMBER	DESCRIPTION
3106CN	100 - 8mm Cage Nuts and 16mm x 8mm Bolts

LIGHT AND HEAVY DUTY CASTOR SETS

The Clipsal light duty castor sets are only for positioning.

The Clipsal heavy duty castor sets allow for full movement of the cabinet and frame.



3106CAS60LD

CATALOGUE NUMBER	DESCRIPTION
3106CAS60LD	Castor Set, Light Duty, to Suit 600mm Wide Cabinet, 300kg Maximum, 90mm (H)
3106CAS76LD	Castor Set, Light Duty, to Suit 760mm Wide Cabinet, 300kg Maximum, 90mm (H)
3106CAS60HD	Castor Set, Heavy Duty, to Suit 600mm x 605mm Cabinet, 800kg Maximum, 150mm (H)
3106CAS80HD	Castor Set, Heavy Duty, to Suit 800mm x 600mm Cabinet, 800kg Maximum, 150mm (H)
3106CAS90HD	Castor Set, Heavy Duty, to Suit 900mm x 600mm Cabinet, 800kg Maximum, 150mm (H)
3106CAS4100HD	Castor Set, Heavy Duty, to Suit 1000mm x 600mm Cabinet, 800kg Maximum, 150mm (H)
3106CAS4110HD	Castor Set, Heavy Duty, to Suit 1100mm x 600mm Cabinet, 800kg Maximum, 150mm (H)
3106CAS4120HD	Castor Set, Heavy Duty, to Suit 1200mm x 600mm Cabinet, 800kg Maximum, 150mm (H)

Cabinet Accessories

EARTHING EQUIPMENT

A complete range of earthing equipment is available for the Clipsal cabinet range to protect your equipment.

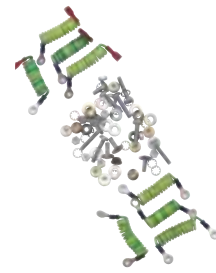

3106EK

CATALOGUE NUMBER	DESCRIPTION
3106EK	Universal Earth Kit
3106EB12	12 Way Earth Neutral Bar
3106EBV18	Earth Bar, Vert Aluminium 18RU
3106EBV39	Earth Bar, Vert Aluminium 39RU
3106EBV45	Earth Bar, Vert Aluminium 45RU

FAN PANEL

If heat is a concern for your installation, then a Clipsal fan panel will be a required item. The fan panels for the Clipsal cabinet range come in two, four and six fan models. With sizing to suit all the Clipsal cabinet range.

The fan panel is used in place of a top cover.

Catalogue Number	Air Movement per Fan	Noise Level per Fan
3106FT SERIES	87 - 107 CFM	45 - 50 dBA



3106FT260

CATALOGUE NUMBER	DESCRIPTION
3106FT260	2 Fan Panel 19" (APO Grey)
3106FT260, TG	2 Fan Panel (Colour to suit Clipsal titanium® Cabinet)
3106FT460	4 Fan Panel 19" (APO Grey)
3106FT460, TG	4 Fan Panel (Colour to suit Clipsal titanium® Cabinet)
3106FT660	6 Fan Panel 19" (APO Grey)

JOINING KITS (BAYING KIT)

The joining kits enable you to join two or more cabinets together.



3106JK

CATALOGUE NUMBER	DESCRIPTION
3106JK	Joining Kit, Suitable to Join Two or More Cabinets Together
3106TCJK	Joining Kit for Clipsal titanium® Cabinet, Suitable to Join Two or More Cabinets Together

Cabinet Accessories

POWER RAILS

If you need a power source in your cabinet, frame or wall cabinet, then the comprehensive range of Clipsal power rails will satisfy all your needs. Power rails can be purchased with two metre flex and plug or with a junction box.

The Clipsal power rails come in both vertical and horizontal versions and are suitable for both Clipsal titanium® and standard cabinets.

Note: Specials available to suit individual requirements.



3106PH6W2FP



3106PV20WJB

DIMENSIONS - POWER VERTICAL

Catalogue Number	Height	Width	Length
3106PV10W2FP	45mm	67mm	1045mm
3106PV13W2FP	45mm	67mm	1600mm
3106PV16W2FP	45mm	67mm	1865mm
3106PV20W2FP	45mm	67mm	1865mm

DIMENSIONS - POWER HORIZONTAL

Catalogue Number	Width	Length	Depth	First to Last	Between Centres of Power Points	Between Edges of Power Points
3106PH6W2FP	87mm	482.8mm	74mm	350mm	70mm	28mm
3106PH10W2FP	128mm	482.8mm	74mm	322mm (H) 56mm (V)	80.5mm (H) 56mm (V)	NA

CATALOGUE NUMBER	DESCRIPTION
3106PH6W1FP	Power Horizontal 6 Way Economy 1M 10A Flex and Plug
3106PH6W2FP	Power Horizontal 6 Way 2M 10A Flex and Plug
3106PH10W2FP	Power Horizontal 10 Way 2M 10A Flex and Plug
3106PV13W2FP	Power Vertical 13 Way 2M 10A Flex and Plug
3106PV16W2FP	Power Vertical 16 Way 2M 10A Flex and Plug
3106PV20W2FP	Power Vertical 20 Way 2M 10A Flex and Plug
3106PV10WJB	Power Vertical 10 Way Junction Box
3106PV16WJB	Power Vertical 16 Way Junction Box
3106PV20WJB	Power Vertical 20 Way Junction Box

Cabinet Accessories

SHELVES

The range of shelves available for the Clipsal cabinet range will fulfil all of your needs. The shelves come in cantilever, telescopic and front fixed versions, in varying depths and heights.

Comes complete with cage nuts and bolts to mount in the Clipsal range of cabinets.



Cantilever



Front Fixed



Telescopic

CATALOGUE NUMBER	DESCRIPTION
Cantilever	
3106SC2U23	2RU Shelf Cantilever 19", 15kg, 230mm
3106SC2U28	2RU Shelf Cantilever 19", 20kg, 280mm
3106SC3U30	3RU Shelf Cantilever 19", 25kg, 300mm
3106SC5U50	5RU Shelf Cantilever 19", 30kg, 500mm
3106SC6U60	6RU Shelf Cantilever 19", 35kg, 600mm
Front Fixed	
3106SF1U41	1RU Shelf Front Fixed 19", 40kg, 410mm
3106SF1U45	1RU Shelf Front Fixed 19", 40kg, 450mm
3106SF1U61	1RU Shelf Front Fixed 19", 40kg, 610mm
3106SF1U71	1RU Shelf Front Fixed 19", 40kg, 710mm
3106SF1U75	1RU Shelf Front Fixed 19", 40kg, 750mm
3106SF1U81	1RU Shelf Front Fixed 19", 40kg, 810mm
3106SF1U91	1RU Shelf Front Fixed 19", 40kg, 910mm
3106SF1U101	1RU Shelf Front Fixed 19", 40kg, 1010mm
Telescopic	
3106ST1U41	1RU Shelf Telescopic 19", 40kg, 410mm
3106ST1U61	1RU Shelf Telescopic 19", 40kg, 610mm
3106ST2U61HD	2RU Shelf Telescopic 19" Heavy Duty, 100kg, 610mm
3106ST2U71HD	2RU Shelf Telescopic 19" Heavy Duty, 100kg, 710mm

Cabinet Accessories

TOPS

The Clipsal cabinet range offers a comprehensive range of tops for your cabinets.

Note: Not suitable for Clipsal titanium® cabinets.

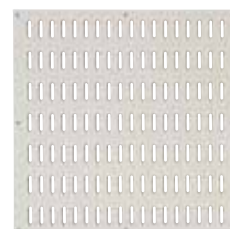

Ventilated Top



Raised Top

CATALOGUE NUMBER	DESCRIPTION
Plain Top	
3106TP60	Top Plain 19", Suits all Clipsal Standard Cabinets
Ventilated Top	
3106TV60	Top Ventilated 19", Suits all Clipsal Standard Cabinets
Raised Top	
3106TR60	Top Raised 19" 600mm x 605mm
3106TR80	Top Raised 19" 800mm x 605mm

SIDE RAILS FOR FREE STANDING CABINETS AND FRAMES

Note: Not suitable for Clipsal titanium® cabinets.

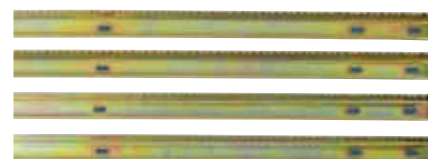

3106VPM18U
(Portion of the Rail Shown)

CATALOGUE NUMBER	DESCRIPTION
3106VPM18U	18RU Vertical Panel Mount Fully Adjustable, 1 Rail
3106VPM39U	39RU Vertical Panel Mount Fully Adjustable, 1 Rail
3106VPM45U	45RU Vertical Panel Mount Fully Adjustable, 1 Rail

Cabinet Accessories

DOORS

A complete range of doors are available to suit all size cabinets. The doors are available in acrylic/metal, glass/metal or full metal and mesh (suitable for front and rear doors).

Note: Not suitable for Clipsal titanium® cabinets.

SPECIFICATIONS - MESH DOOR

Mild Steel	1.6mm
Punch Diameter	4.76mm
Pitch	6.35mm
Open Air Flow	51 y

KEY NUMBER

CL003



3106AMD39

CATALOGUE NUMBER	DESCRIPTION
Acrylic/Metal	
3106AMD18	18RU Door, Tinted Acrylic with Metal Surround (APO Grey)
3106AMD27	27RU Door, Tinted Acrylic with Metal Surround (APO Grey)
3106AMD39	39RU Door, Tinted Acrylic with Metal Surround (APO Grey)
3106AMD45	45RU Door, Tinted Acrylic with Metal Surround (APO Grey)
3106AMD4524	45RU 760mm Door, Tinted Acrylic with Metal Surround (APO Grey)
GLASS/METAL	
3106GD45	45RU Door, Glass with Metal Surround
Metal	
3106MD27	27RU Door, Full Metal (APO Grey)
3106MD39	39RU Door, Full Metal (APO Grey)
3106MD45	45RU Door, Full Metal (APO Grey)
3106MD4524	45RU 760mm Door, Full Metal (APO Grey)
Mesh Doors	
3106BMMD39	39RU 605mm Door, Mesh (Black Mesh with APO Grey Metal Surround)
3106BMMD45	45RU 605mm Door, Mesh (Black Mesh with APO Grey Metal Surround)
3106BMMD4524	45RU 760mm Door, Mesh (Black Mesh with APO Grey Metal Surround)
Door Packs	
3106DP18	Door Pack 18RU Front and Rear, Front Door Metal/ Tinted Acrylic - Rear Door Metal (APO Grey)
3106DP27	Door Pack 27RU Front and Rear, Front Door Metal/ Tinted Acrylic - Rear Door Metal (APO Grey)
3106DP39	Door Pack 39RU Front and Rear, Front Door Metal/ Tinted Acrylic - Rear Door Metal (APO Grey)
3106DP45	Door Pack 45RU Front and Rear, Front Door Metal/ Tinted Acrylic - Rear Door Metal (APO Grey)
3106DP4524	Door Pack 45RU Front and Rear, Front Door Metal/ Tinted Acrylic - Rear Door Metal, 760mm (APO Grey)

Cabinet Accessories

SIDE PANELS

Side panels are available to suit all size cabinets including 600mm, 800mm, 900mm, 1000mm, 1100mm, and 1200mm deep units.

PRODUCT FEATURES

- Three rows of vents, top and bottom of panel.
- Snap-lockable, provision for key lock.



3106VSP39U60

CATALOGUE NUMBER	DESCRIPTION
Side Panels	
3106SP18U60	18RU Side Panel Full Metal Lockable 600mm Deep
3106SP27U60	27RU Side Panel Full Metal Lockable 600mm Deep
3106SP39U60	39RU Side Panel Full Metal Lockable 600mm Deep
3106SP39U80	39RU Side Panel Full Metal Lockable 800mm Deep
3106SP45U60	45RU Side Panel Full Metal Lockable 600mm Deep
3106SP45U80	45RU Side Panel Full Metal Lockable 800mm Deep
3106SP45U90	45RU Side Panel Full Metal Lockable 900mm Deep
3106SP45U100	45RU Side Panel Full Metal Lockable 1000mm Deep
3106SP45U120	45RU Side Panel Full Metal Lockable 1200mm Deep
Vented Side Panels	
3106VSP18U60	18RU Vented Side Panels 600mm Deep, 2pk
3106VSP27U60	27RU Vented Side Panels 600mm Deep, 2pk
3106VSP39U60	39RU Vented Side Panels 600mm Deep, 2pk
3106VSP39U80	39RU Vented Side Panels 800mm Deep, 2pk
3106VSP39U90	39RU Vented Side Panels 900mm Deep, 2pk
3106VSP45U60	45RU Vented Side Panels 600mm Deep, 2pk
3106VSP45U80	45RU Vented Side Panels 800mm Deep, 2pk
3106VSP45U90	45RU Vented Side Panels 900mm Deep, 2pk
3106VSP45U100	45RU Vented Side Panels 1000mm Deep, 2pk
3106VSP45U110	45RU Vented Side Panels 1100mm Deep, 2pk
3106VSP45U120	45RU Vented Side Panels 1200mm Deep, 2pk

SIDE PANEL LOCK

If you wish to lock the side panels, an easy-to-fit lock is available.

Note: Not suitable for Clipsal titanium® cabinets.



3106SPL

CATALOGUE NUMBER	DESCRIPTION
3106SPL	Side Panel Cam Lock #CL003

Cabinet Accessories

CABLE MANAGEMENT PRODUCTS - CLIPSAL TITANIUM®

A comprehensive range of cable management products are available to suit the Clipsal titanium® range. Horizontal and vertical rails are available for all installation needs.



3106TVCM27 - Vertical
(Portion of the cable management shown)



3106THCM80 - Horizontal

CATALOGUE NUMBER	DESCRIPTION
3106TVCM39	Cable Management Vertical, to Suit 39RU titanium® Cabinet
3106TVCM45	Cable Management Vertical, to Suit 45RU titanium® Cabinet
3106THCM80	Cable Manager, Front to Rear Rail, to Suit 800mm Deep Clipsal titanium® cabinet
3106THCM90	Cable Manager, Front to Rear Rail, to Suit 900mm Deep Clipsal titanium® cabinet
3106THCM100	Cable Manager, Front to Rear Rail, to Suit 1000mm Deep Clipsal titanium® cabinet

CHIMNEYS

Chimneys are an excellent means of routing cables between the roof space and the top of a cabinet. These telescopic chimneys allow installers to alter the height to their own specific requirements.



3106TCD55/100

CATALOGUE NUMBER	DESCRIPTION
3106TCD55/100	Clipsal titanium® Cabinet Cable Chimney, 550-1000mm, 300mm (W) x 100mm (D)
3106CD55/100	Cabinet Cable Chimney, 550-1000mm, 300mm (W) x 100mm (D)
3106CD85/160	Cabinet Cable Chimney, 850-1600mm, 300mm (W) x 100mm (D)

Cabinet Accessories

CABLE TRAYS

Cable trays are available for the 12RU and 18RU wall cabinets. Available in three different widths, the cable trays can cater for all different size installations.

Note: Not suitable for Clipsal titanium® cabinets.

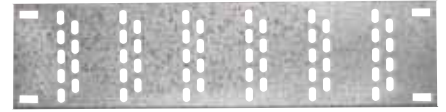

3106CT12U15

CATALOGUE NUMBER	DESCRIPTION
3106CT12U15	12RU Cable Tray 150mm
3106CT12U30	12RU Cable Tray 300mm
3106CT18U15	18RU Cable Tray 150mm
3106CT18U22	18RU Cable Tray 225mm
3106CT18U30	18RU Cable Tray 300mm

DOORS - WALL CABINET ACCESSORIES

A range of fully acrylic doors are available for the wall cabinets. For the 18RU wall cabinets a stronger door using acrylic with a metal surround, is available.

Note: Not suitable for Clipsal titanium® cabinets.



3106DA6U

DOOR LOCK KEY NUMBER

CL003

CATALOGUE NUMBER	DESCRIPTION
3106DA6U	6RU Door Full Acrylic
3106DA12U	12RU Door Full Acrylic
3106DMA12U	12RU Door Acrylic/Metal Surround (APO Grey)
3106DMA18U	18RU Door Acrylic/Metal Surround (APO Grey)

HINGED WALL MOUNT KITS - WALL CABINET ACCESSORIES

Many installations call for a hinged wall cabinet. By the use of the hinged wall mount kit with its unique "invisible" hinge, any Clipsal wall cabinet can become a lockable hinged wall cabinet.

Note: Not suitable for Clipsal titanium® cabinets.



3106HWMK6U

CATALOGUE NUMBER	DESCRIPTION
3106HWMK6U	6RU Hinged Wall Mount Kit, APO Grey
3106HWMK12U	12RU Hinged Wall Mount Kit, APO Grey
3106HWMK18U	18RU Hinged Wall Mount Kit, APO Grey

Cabinet Accessories

REAR MOUNT RAILS - WALL CABINET

Rear mount rails can be used for mounting accessories into the back of wall cabinets.

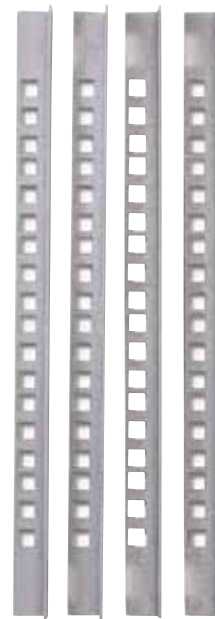

3106VPMW6U

CATALOGUE NUMBER	DESCRIPTION
3106VPMW6U	6RU VPM Front Fixed, Wall Cabinet
3106VPMW12U	12RU VPM Front Fixed, Wall Cabinet
3106VPMW18U	18RU VPM Front Fixed, Wall Cabinet

REAR MOUNT RAILS - WALL CABINET, CLIPSAL TITANIUM®

Rear mount rails can be used for mounting accessories into the back of a Clipsal titanium® wall cabinet.

CATALOGUE NUMBER	DESCRIPTION
3106WTC6URR	6RU Rear Mount Rails, 1 Set of 2
3106WTC12URR	12RU Rear Mount Rails, 1 Set of 2
3106WTC618URR	18RU Rear Mount Rails, 1 Set of 2

Cabinet Accessories

VERTICAL CABLE MANAGEMENT DUCT

The Clipsal vertical cable management duct is part of the standard 3106 Series range of cabinets accessories that is used to manage patch cords within the cabinet. One supplied per pack.

DIMENSIONS

Catalogue Number	Rack Unit	Depth	Width
3106VCMD45, BK	45	65mm	70mm



3106VCMD45, BK

PRODUCT FEATURES

- Heavy duty.
- Sectional cover.
- Hinged.
- Black ripple finish.
- Easy to install.
- Fits standard 3106 Series cabinets 800mm wide (24").
- Two required per cabinet.
- Fixing hardware supplied.

CATALOGUE NUMBER	DESCRIPTION
3106VCMD27, BK	27RU Metal Hinged Cable Duct
3106VCMD45, BK	45RU Metal Hinged Cable Duct



DUCTING AND FITTINGS

Inspection Elbows and Tees

Couplings and Bends

Clear Conduit Fittings

Ducting Systems

Duct Fittings

Adaptors

Elbows

Duct Couplings

Intersection Tees

Mounting Accessories

Mounting Blocks

Adhesive Tape

Jointing Cement

Clipsal Ducting and Fittings

Clipsal provides a range of ducting and fittings to suit many types of data installations - from the secure application for defence, to the smaller, less secure application using standard white fittings. All Clipsal fittings are manufactured from high quality, high impact Polyvinyl Chloride (PVC) containing titanium dioxide for UV and chemical resistance.

MANUFACTURING SPECIFICATIONS

All Clipsal non metallic conduit and fittings are manufactured in strict accordance with relevant sections of AS/NZS 2053 Conduit and Fittings for Electrical Installations. Operative temperature range -15°C to +65°C. Most Clipsal conduit fittings are suitable for use underground and are marked HD (heavy duty).

Note: Screw threads of nominal sizes of conduit 16 to 63mm are metric conduit threads with a 1.5mm pitch, complying with AS 1721. Sizes 80 to 150 are BSP threads complying with AS 1722. Unless specified otherwise, all dimensions are nominal.

CHEMICAL RESISTANCE

Resistance to most common corroding agents, including the majority of oils and fats, inorganic acids, alkalis and salts, is a feature of these products. However, they are not recommended for use with ketones, esters or aromatic or chlorinated hydrocarbons.

JOINTING - RECOMMENDED METHOD FOR CONDUIT FITTINGS

The following is a simple, quick method using Clipsal Jointing Cement.

1. Cut conduit to length and remove all burrs.
2. Remove any dirt or grease with a clean cloth dipped in methylated spirits.
3. Coat both surfaces to be joined and, within one minute, push together. Give a quarter turn to spread cement evenly and wipe off excess immediately.
4. Do not handle joint for five minutes and allow 24 hours drying time before testing or rough handling.

Please refer to page 210 for complete details on Clipsal jointing cement.

Inspection Elbows and Tees

INSPECTION ELBOWS - 90° ANGLE

The C244 Series is a range of 90 degree inspection elbows, from 20mm through to 32mm. The design allows the elbow to fit into corners neatly and the inspection cover removes, to allow easy wiring and rewiring.

DIMENSIONS

Product	Nominal Size	Height (inc. Lid)	I.D.	O.D.	A	B
C244/20	20mm	28mm	20mm	25mm	59mm	59mm
C244/25	25mm	35mm	25mm	30mm	66mm	66mm
C244/32	32mm	41mm	32mm	37mm	80mm	80mm



C244 Series

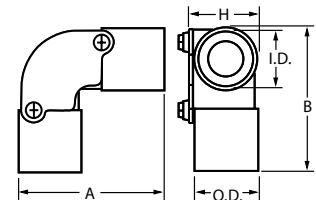

CATALOGUE NUMBER	DESCRIPTION
C244/20	20mm Inspection Elbow - 90° Angle
C244/25	25mm Inspection Elbow - 90° Angle
C244/32	32mm Inspection Elbow - 90° Angle

SOLID ELBOWS - 90° ANGLE

The C245 Series is a range of 90 degree solid elbows in 20mm and 25mm. The design allows the elbow to fit into corners neatly.

DIMENSIONS

Product	Nominal Size	I.D.	O.D.	A	R
C245/20	20mm	20mm	25mm	54mm	22mm
C245/25	25mm	25mm	30mm	66mm	28mm



C245 Series

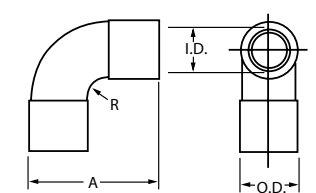

CATALOGUE NUMBER	DESCRIPTION
C245/20	20mm Solid Elbow - 90° Angle
C245/25	25mm Solid Elbow - 90° Angle

INSPECTION TEES

The C246 Series is a range of inspection tees from 20mm through to 32mm. The screw fixed inspection cover removes to allow easy wiring and rewiring.

DIMENSIONS

Product	Nominal Size	Height (inc. Lid)	I.D.	O.D.	A	B
C246/20	20mm	29mm	20mm	25mm	55mm	92mm
C246/25	25mm	37mm	25mm	30mm	69mm	108mm
C246/32	32mm	44mm	32mm	37mm	82mm	127mm



C246 Series

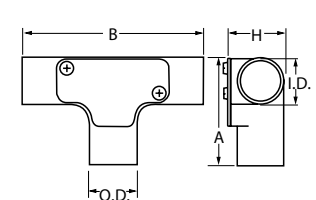

CATALOGUE NUMBER	DESCRIPTION
C246/20	20mm Inspection Tee
C246/25	25mm Inspection Tee
C246/32	32mm Inspection Tee

Couplings and Bends

COUPLINGS

Plain couplings allow joining of two lengths of conduit of the same size.

DIMENSIONS

Product	Nominal Size	I.D.	O.D.	L
C242/20	20mm	20mm	25mm	42mm
C242/25	25mm	25mm	30mm	42mm
C242/32	32mm	32mm	37mm	52mm
C242/40	40mm	40mm	45mm	58mm
C242/50	50mm	50mm	57mm	80mm

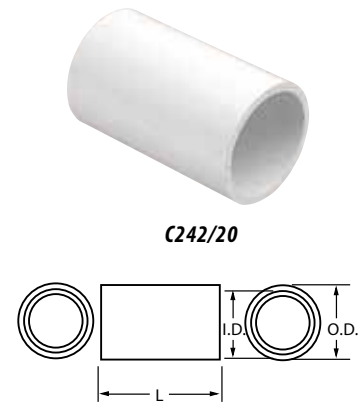

C242/20

CATALOGUE NUMBER	DESCRIPTION
C242/20	20mm Plain Coupling
C242/25	25mm Plain Coupling
C242/32	32mm Plain Coupling
C242/40	40mm Plain Coupling
C242/50	50mm Plain Coupling

BENDS - 90° ANGLE

The range of standard bends is from 20mm through to 32mm.

DIMENSIONS

Product	Nominal Size	I.D.	O.D.	A	R
C247/20	20mm	20mm	24mm	83mm	54mm
C247/25	25mm	25mm	29mm	106mm	76mm
C247/32	32mm	32mm	37mm	153mm	108mm



C247 Series

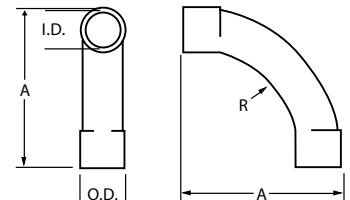

CATALOGUE NUMBER	DESCRIPTION
C247/20	20mm Bend - 90° Angle
C247/25	25mm Bend - 90° Angle
C247/32	32mm Bend - 90° Angle

LARGE SWEEP BENDS - 90° ANGLE

Available in a range of sizes from 20mm to 50mm sizes.

DIMENSIONS

Product	Nominal Size	I.D.	O.D.	A	R
C247L20	20mm	20mm	22mm	185mm	150mm
C247L25	25mm	25mm	28mm	192mm	150mm
C247L32	32mm	32mm	35mm	350mm	312mm
C247L50	50mm	50mm	53mm	360mm	320mm



C247L Series

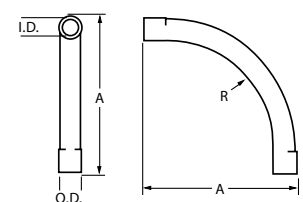

CATALOGUE NUMBER	DESCRIPTION
C247L20	20mm Large Sweep Bend - 90° Angle
C247L25	25mm Large Sweep Bend - 90° Angle
C247L32	32mm Large Sweep Bend - 90° Angle
C247L50	50mm Large Sweep Bend - 90° Angle

Clear Conduit Fittings

With the increasing need for certainty of integrity of data and security cabling systems, Clipsal offers a range of transparent conduit and fittings. Clipsal's security conduit and fittings are specially designed for cabling systems used in high security areas for carrying highly sensitive or confidential data. Being transparent enables the integrity of the cable to be inspected at all points along the route, ensuring that any damage or tampering is immediately identified. Transparent conduit also ensures that a security conduit run isn't mistaken for electrical or other data and communications circuitry, and opened in error. Another advantage is that it allows easy identification of entry of pests, vermin, moisture or other contaminants, which may affect the performance of the system. Normal clear conduit cement is ideal for bonding of the joints.

PLAIN TO SCREW ADAPTORS

Plain to screwed adaptors allow rigid conduit to be terminated into an enclosure and secured with a lock ring or lock nut. They are available for conduit sizes 20mm through to 50mm. Lock rings are purchased separately.



SC263/32

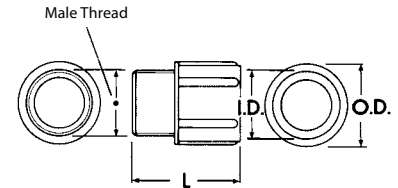

DIMENSIONS

Product	Male Thread Number	Length	Nominal Inside Diameter	Nominal Outside Diameter
SC263/20	20mm	36mm	20mm	25mm
SC263/25	25mm	42mm	25mm	32mm
SC263/32	32mm	46mm	32mm	38mm
SC263/40	40mm	50mm	40mm	47mm
SC263/50	50mm	64mm	50mm	59mm

CATALOGUE NUMBER	DESCRIPTION
SC263/20	20mm Plain to Screwed Adaptor
SC263/25	25mm Plain to Screwed Adaptor
SC263/32	32mm Plain to Screwed Adaptor
SC263/40	40mm Plain to Screwed Adaptor
SC263/50	50mm Plain to Screwed Adaptor

LOCK RINGS

To suit 263 Series plain to screwed adaptors. Colours: Grey (GY), Orange (EO).



260/20

DIMENSIONS

Product	Internal Thread	Nominal Outside Diameter	Nominal Thickness
260/16	16mm	25mm	4.6mm
260/20	20mm	29mm	5mm
260/25, GY	25mm	34mm	5mm
260/32	32mm	40mm	9.5mm
260/40	40mm	50mm	11mm
260/50	50mm	60mm	12.5mm

CATALOGUE NUMBER	DESCRIPTION
260/16	16mm Lock Rings
260/20	20mm Lock Rings
260/25, GY	25mm Lock Rings
260/32	32mm Lock Rings
260/40	40mm Lock Rings
260/50	50mm Lock Rings

Clear Conduit Fittings

90° BENDS

The range of standard bends is from 16mm through to 50mm.

DIMENSIONS

Product	Nominal Size	A	R
SC247/16	16mm	68mm	41mm
SC247/20	20mm	83mm	47mm
SC247/25	25mm	106mm	64mm
SC247/32	32mm	134mm	83mm
SC247/40	40mm	155mm	100mm
SC247/50	50mm	205mm	120mm



SC247/20

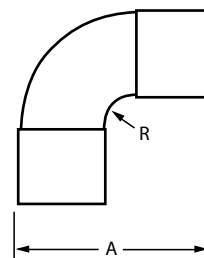

CATALOGUE NUMBER	DESCRIPTION
SC247/20	20mm Bend - 90° Angle
SC247/25	25mm Bend - 90° Angle
SC247/32	32mm Bend - 90° Angle

INSPECTION TEES

The 246 Series is a range of inspection tees from 16mm through to 50mm. The screw fixed inspection cover removes to allow easy wiring and rewiring. The lid is removed by inserting a screwdriver in the tab slots and levering.

DIMENSIONS

Product	Nominal Size	Inside Diameter	Outside Diameter	A	B	Height
SC246/16	16mm	16mm	20mm	55mm	92mm	29mm
SC246/20	20mm	20mm	25mm	55mm	92mm	29mm
SC246/25	25mm	25mm	30mm	69mm	108mm	37mm
SC246/32	32mm	32mm	37mm	82mm	127mm	44mm



SC246 Series

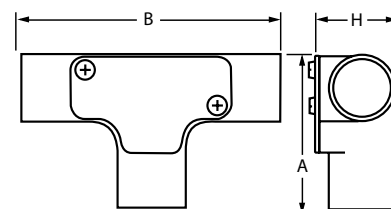

CATALOGUE NUMBER	DESCRIPTION
SC246/16	16mm Inspection Tee
SC246/20	20mm Inspection Tee
SC246/25	25mm Inspection Tee
SC246/32	32mm Inspection Tee

Clear Conduit Fittings

90° SOLID ELBOWS

The 245 Series is a range of 90 degree solid elbows in sizes 20mm and 25mm. The design allows the elbow to fit into corners neatly.

DIMENSIONS

Product	Nominal Size	Nominal Outside Diameter	A
SC245/20	20mm	25mm	54mm
SC245/25	25mm	30mm	66mm



SC245/20

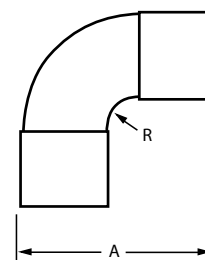

CATALOGUE NUMBER	DESCRIPTION
SC245/20	20mm Solid Elbow
SC245/25	25mm Solid Elbow

COUPLINGS

Plain couplings allow joining of two lengths of conduit the same size.

DIMENSIONS

Product	Nominal Size (I.D.)	Outside Diameter	Length
SC242/20	20mm	25mm	42mm
SC242/25	25mm	30mm	42mm
SC242/32	32mm	37mm	52mm
SC242/40	40mm	45mm	58mm
SC242/50	50mm	57mm	80mm



SC242/20

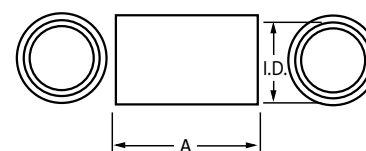

CATALOGUE NUMBER	DESCRIPTION
SC242/20	20mm Plain Coupling
SC242/25	25mm Plain Coupling
SC242/32	32mm Plain Coupling
SC242/40	40mm Plain Coupling
SC242/50	50mm Plain Coupling

JUNCTION BOX LID

A useful accessory when mounting light fittings on a jack chain. The 240L provides a suspension point for the chain, and enables the supply flex to exit the junction box adjacent to it, allowing it to run neatly down the chain to the fitting.



SC240L

CATALOGUE NUMBER	DESCRIPTION
SC240L	240 Series Junction Box Lid

Ducting Systems

Ducting systems are the ideal alternative to conduit for surface wiring in domestic, commercial, and industrial environments, particularly when renovations, rewiring, and additions are being undertaken.

Ducting systems are easily installed, either fastened with screws or with double sided tape. A broad range of accessories makes installation easy. Butt or mitre joints are also suitable. The range extends from 16mm x 10mm through to 100mm x 100mm. Colour options are White Electric (WE) and Grey (GY). Not all products are available in all colours.

900 SERIES MINI DUCT

Clipsal duct is divided into mini duct and maxi duct.

Colours: White Electric (WE) and Grey (GY).

Standard length is 4 metres. Some 3.1 metre products also available.



900/40/16

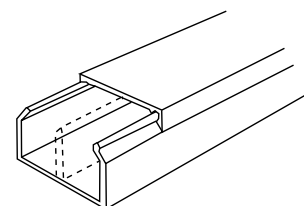

900/25, 900/40, 900/40/2

CATALOGUE NUMBER	DESCRIPTION
900/16/10	16 x 10mm Mini Duct
900/16/16	16 x 16mm Mini Duct
900/16/16PT	16 x 16mm Pre-taped Mini Duct
900/25/16	25 x 16mm Mini Duct
900/25/16PT	25 x 16mm Pre-taped Mini Duct
900/25/25	25 x 25mm Mini Duct
900/25/25PT	25 x 25mm Pre-taped Mini Duct
900/40/16, WE	40 x 16mm Mini Duct
900/40/25	40 x 25mm Mini Duct
900/40/25/2	40 x 25mm Twin Compartment Rectangular Mini Duct
900/50/25, WE	50 x 25mm Mini Duct
900/60/25	60 x 25mm Mini Duct
900/60/40, WE	60 x 40mm Mini Duct

Ducting Systems

900 SERIES MAXI DUCT

Standard colour Grey (GY). Some products also available in White Electric (WE). Standard length is 4 metres.

The Clipsal maxi duct range offers larger sizes to accommodate more cables. These ducts are manufactured from PVC.

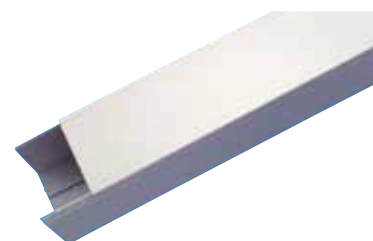

900/100/100



900/150/50

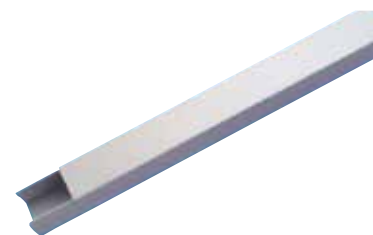

900/50/50

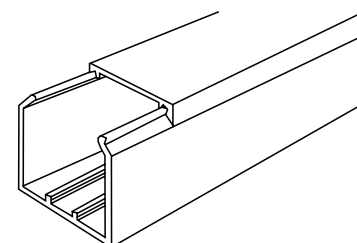

Maxi Trunking

CATALOGUE NUMBER	DESCRIPTION
900/50/50, GY	50 x 50mm Maxi Trunking
900/75/50, GY	75 x 50mm Maxi Trunking
900/100/50, GY	100 x 50mm Maxi Trunking
900/75/75, GY	75 x 75mm Maxi Trunking
900/100/75, GY	100 x 75mm Maxi Trunking
900/100/100*	100 x 100mm Maxi Trunking
900/150/50, GY	150 x 50mm Maxi Trunking
900/150/75, GY	150 x 75mm Maxi Trunking

*Available in White Electric (WE)

Duct Fittings

DUCT FITTINGS

A broad range of Clipsal fittings are available for the various duct sizes.

Colour: White (WE)



900/16/16P

DIMENSIONS

Product	Length	Width	Height
900/16/16P	13mm	16mm	16mm
900/25/16P	13mm	25mm	16mm
900/40/25P	14mm	40mm	25mm

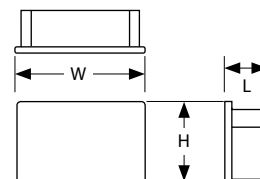

CATALOGUE NUMBER	DESCRIPTION
900/16/16P, WE	Plug for 16 x 16mm Duct
900/25/16P, WE	Plug for 25 x 16mm Duct
900/40/25P, WE	Plug for 40 x 25mm Duct

END PLUGS

End plugs are used to blank off a duct end.

Colour: Grey (GY)



900/50/50P

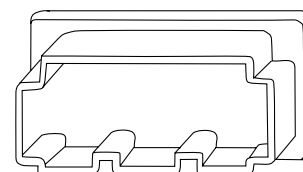

End Plug

CATALOGUE NUMBER	DESCRIPTION
900/50/50P, GY	50 x 50mm End Plug
900/75/50P, GY	75 x 50mm End Plug
900/100/50P, GY	100 x 50mm End Plug
900/75/75P, GY	75 x 75mm End Plug
900/100/75P, GY	100 x 75mm End Plug
900/100/100P, GY	100 x 100mm End Plug

Adaptors

Adaptors allow conversion of various duct sizes to 16mm x 25mm duct and accessories.

Colour: White (WE)

DIMENSIONS

Product	Length	Width	Height
900/40TA25	60mm	66mm	22.8mm
900/16A16	47.4mm	17.75mm	25.2mm
900/25A25	47.4mm	27mm	29.81mm
900/40A25	37.80mm	40mm	17.3mm



900/40A25

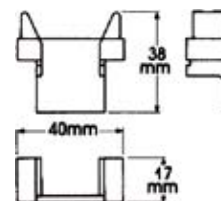

900/40A25

CATALOGUE NUMBER	DESCRIPTION
900/40TA25, WE	Allows 25 x 16mm Duct to Tee Off a 40 x 25mm Duct
900/16A16, WE	Converts 16 x 16mm Duct to 25 x 16mm Duct and Accessories with 25 x 16mm Entries
900/25A25, WE	Converts 25 x 25mm Duct to 25 x 16mm Duct and Accessories with 25 x 16mm Entries
900/40A25, WE	Converts 40 x 25mm Duct to 25 x 16mm Duct and Accessories with 25 x 16mm Entries

Elbows

MINI DUCT INTERNAL ELBOWS

Mini duct elbows are clip-on covers for internal corners. Colour: White (WE).

Product	Length	Width	Height
900/16/16EI	43mm	20mm	43mm
900/25/16EI	41mm	29mm	41mm
900/40/25EI	57mm	39mm	57mm



900/25/16EI

CATALOGUE NUMBER	DESCRIPTION
900/16/16EI, WE	Internal Elbow for 16 x 16mm Duct
900/25/16EI, WE	Internal Elbow for 25 x 16mm Duct
900/40/25EI, WE	Internal Elbow for 40 x 25mm Duct

MAXI DUCT INTERNAL ELBOWS

Maxi duct elbows are a prefabricated corner piece. Colour: Grey (GY).



900/50/100EI

CATALOGUE NUMBER	DESCRIPTION
900/50/50EI, GY	50 x 50mm Internal Elbow
900/75/50EI, GY	75 x 50mm Internal Elbow
900/100/50EI, GY	100 x 50mm Internal Elbow
900/75/75EI, GY	75 x 75mm Internal Elbow
900/100/75EI, GY	100 x 75mm Internal Elbow

MINI DUCT EXTERNAL ELBOWS

Mini duct elbows are clip-on covers for internal corners. Colour: White (WE).

Product	Length	Width	Height
900/16/16EE	43mm	20mm	43mm
900/25/16EE	43mm	29mm	43mm
900/40/25EE	59mm	44mm	59mm



900EE Series

CATALOGUE NUMBER	DESCRIPTION
900/16/16EE, WE	External Elbow for 16 x 16mm Duct
900/25/16EE, WE	External Elbow for 25 x 16mm Duct
900/40/25EE, WE	External Elbow for 40 x 25mm Duct

MAXI DUCT EXTERNAL ELBOWS

Maxi duct elbows are a prefabricated corner piece. Colour: Grey (GY).



External Elbow

CATALOGUE NUMBER	DESCRIPTION
900/50/50EE, GY	50 x 50mm External Elbow
900/75/50EE, GY	75 x 50mm External Elbow
900/100/50EE, GY	100 x 50mm External Elbow
900/75/75EE, GY	75 x 75mm External Elbow
900/100/75EE, GY	100 x 75mm External Elbow

Duct Couplings

MINI DUCT COUPLINGS

Couplings are clip-on covers to butt joints in duct. Colour: White (WE).

DIMENSIONS

Product	Length (A)	Width (B)	Height (C)
900/16/16C	50mm	20mm	18mm
900/25/16C	50mm	29mm	18mm
900/40/25C	44mm	37mm	21mm



900/25/16C

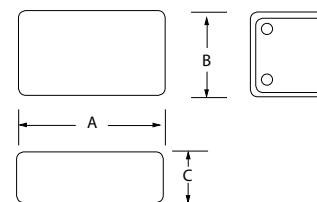

900/25/16C

CATALOGUE NUMBER	DESCRIPTION
900/16/16C, WE	Coupling for 16 x 16mm Duct
900/25/16C, WE	Coupling for 25 x 16mm Duct
900/40/25C, WE	Coupling for 40 x 25mm Duct

MAXI DUCT COUPLINGS

Clip-on covers to butt joints in duct. Colour: Grey (GY).



900/75C

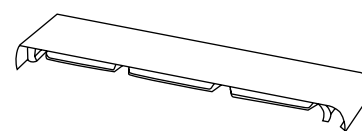

Coupling

CATALOGUE NUMBER	DESCRIPTION
900/50C, GY	50mm Coupling
900/75C, GY	75mm Coupling
900/100C, GY	100mm Coupling

Intersection Tees

INTERSECTION TEES

Clip-on covers to tee off a flat elbow at right angles. Left and right hand versions are available. Only available in some mini duct sizes. Colour: White (WE).



900/25/16TR

DIMENSIONS

Product	Length	Width	Height
900/25/16TR	52mm	40mm	52mm
900/25/16TL	52mm	40mm	52mm

CATALOGUE NUMBER	DESCRIPTION
900/25/16TR, WE	Right Tee (Intersection) for 25 x 16mm Duct
900/25/16TL, WE	Left Tee (Intersection) for 25 x 16mm Duct

CLIP-IN SEPARATORS - MAXI TRUNKING

Clip-in divider to provide segregation in 50mm and 75mm maxi duct.

Standard length: 4 metres. Colour: White (WE).



900D75S

CATALOGUE NUMBER	DESCRIPTION
900D50S, WE	Suits 100 x 50mm Maxi Trunking
900D75S, WE	Suits 100 x 75mm Maxi Trunking

CONNECTOR CLIP - MAXI TRUNKING

Clips to join lengths of maxi trunking together. Suits all maxi trunking except 50 x 50mm size two.

Colour: White (WE)



900CC

CATALOGUE NUMBER	DESCRIPTION
900CC, WE	Connector Clip to Join All Sizes of Maxi Trunking (50 x 50mm size excepted).

CLIP-IN CABLE RETAINERS

Clip to retain cable in duct prior to installation of the lid. Available in White Electric (WE).



900C75

CATALOGUE NUMBER	DESCRIPTION
900C75	100 x 75mm Maxi Trunking

Mounting Accessories

STANDARD PATTERN MOUNTING BOX

The 900SPMB is a standard pattern surface mounting box for single gang accessories. Internal depth is 33mm. Features four 25 x 16mm trunking entries, including one on each end and side. Supplied with three Cat. No. 900MBC clip-in/push-out caps, four Cat. No. 220/10 Insulating Caps and two M3.5 x 0.8 x 16mm long pan head screws. Screws thread into brass inserts.

Colour: White (WE) and Grey (GY)

DIMENSIONS

PRODUCT	Length	Width	Height
900SPMB	116mm	74mm	38mm



900SPMB

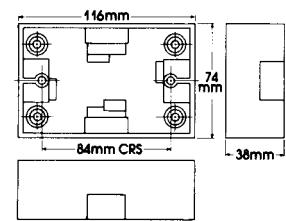

900SPMB

CATALOGUE NUMBER	DESCRIPTION
900SPMB	Standard Pattern Mounting Box - 38mm High

ROUND MOUNTING BLOCK

The 900RMB is a round surface mounting block for mounting round accessories. Internal depth: 15mm. Features two 25 x 16mm trunking entries. Through entries number of mounting positions: two. Supplied with one (Cat No. 900MBC) clip-in/push-out cap, two (Cat. No. 220/10) insulating caps, and two 3/ 16" BSW x 12mm long pan head screws.

Colour: White (WE)

DIMENSIONS

Product	Length	Width	Height
900RMB	84mm	66mm	18mm



900RMB

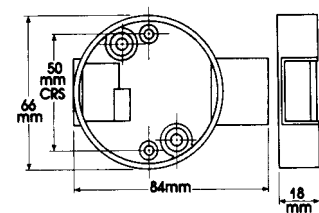

900RMB

CATALOGUE NUMBER	DESCRIPTION
900RMB	Round Mounting Block - 18mm High

Mounting Blocks

MOUNTING BLOCK/BOX ENTRY CAP

Spare entry blanking cap for mounting accessories.



900MBC

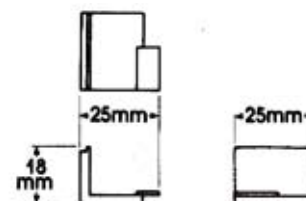

900MBC

CATALOGUE NUMBER	DESCRIPTION
900MBC, WE	Mounting Block Entry Cap Suitable for 25 x 16mm Trunking Entries. Colour: White (WE).

STANDARD PATTERN MOUNTING BLOCK

The 900SPBP is a single gang standard pattern mounting block. Accepts 25 x 16mm and 16 x 16mm trunking through twelve 16 x 16mm and eight 25 x 16mm combination head screws for mounting.

Colour: White (WE)

DIMENSIONS

Product	Length	Width	Height	Mounting Centres
900SPBP	120mm	76mm	20mm	84mm



900SPBP

CATALOGUE NUMBER	DESCRIPTION
900SPBP	Standard Pattern Mounting Block - 20mm High

Adhesive Tape

DOUBLE-SIDED ADHESIVE TAPE

Double-sided tape provides a quick and convenient method of mounting duct. Surfaces must be clean and dry, and free of dirt, dust, moisture, grease and flaking paint. It must be firmly applied along the full length of the duct to ensure secure fixing. Large sizes may require two rows of tape.



900AT Series

CATALOGUE NUMBER	DESCRIPTION
900AT12	12mm Wide Double-Sided Impact Adhesive Tape, 50m Roll
900AT18	18mm Wide Double-Sided Impact Adhesive Tape, 50m Roll
900AT24	24mm Wide Double-Sided Impact Adhesive Tape, 50m Roll

Jointing Cement

JOINTING CEMENT

Clipsal low vapour jointing cement is the result of our strong commitment to the preservation and protection of the environment. Safer for the user and environment, this cement is a single, low toxic, biodegradable solvent that also offers improved bonding. With virtually no smell or fumes, it is ideal for use in confined spaces or areas with poor ventilation. Its convenient 250ml twist top squeeze bottles enable "no spill" use in the tightest situations and have chemical stability and low flammability, for safe transporting and storage.

PVC SOLVENT CEMENT RANGE

Clipsal solvent jointing cements are benzene free for greater safety; thicker in consistency to avoid spillage and packaged in long life, airtight storage containers. They are available in blue and clear, in a choice of four container sizes, each with a brush incorporated into the lid. The clear cement is also available in a handy twist-top 250ml squeeze bottle for no spill, safe handling.



240/250GR



240/500CL



240/500BU

CATALOGUE NUMBER	DESCRIPTION
Medium Gap Filling Safety Jointing Cement	
240/250GR	250ml Squeeze Bottle
Medium Gap Filling Clear PVC Jointing Cement	
240A	250ml Squeeze Bottle
240/125CL	125ml Bottle with Brush
240/250CL	250ml Bottle with Brush
240/500CL	500ml Bottle with Brush
240/1000CL	1000ml Bottle with Brush
Medium Gap Filling Blue PVC Jointing Cement	
240/125BU	125ml Bottle with Brush
240/250BU	250ml Bottle with Brush
240/500BU	500ml Bottle with Brush
240/1000BU	1000ml Bottle with Brush



MISCELLANEOUS SECTION

Installation Tools

Line Testers

Installation Tools

TERMINATION TOOLS

Clipsal's IDC termination tools are designed to provide a reliable connection. Their cut-off gives positive wire trimming even on older blocks. They have a low impact force to ease strain and prevent damage to installations.

The 3100RJA5V tool has a swivel head, allowing termination of the Clipsal 3100 Patch by Exception Series modules.



3100RJA5V



TRJ45PDT



TRJ45PDTB

CATALOGUE NUMBER	DESCRIPTION
3100RJA5V	IDC Termination Tool. Will Terminate the Clipsal 3104 and 3100 Series Modules as well as KATT and Krone Terminations
TRJ45PDT	110 Punchdown Tool. Will Terminate the Clipsal Actassi Range of RJ45 Connectors
TRJ45PDTB	Punchdown Tool Replacement Blade for the 110 Punchdown Tool, TRJ45PDT. Will Terminate the Clipsal Actassi Range of RJ45 Connectors

Line Testers

The Clipsal single line tester provides instant identification of the most common voice and data cabling problems, including short, open and incorrect polarity. The master and remote units separate for end-to-end testing of installed cabling. Short, open or mis-wires are easily detected within seconds. The continuously sequencing LED display immediately alerts you to problems in the cabling system. Both pieces simply snap and lock together when not in use, making it easy to carry and store. Designed to fit neatly into a toolbox or pocket, the tester has a durable nylon carry case to ensure the protection of the device when not in use.



SLT



SLTU

PRODUCT FEATURES

- Innovative 3-in-1 design features modular sockets for testing USOC, 568A/B and RS423 (MMJ) cabling systems.
- Accurately verifies the continuity and sequence of 1, 2, 3 and four pair voice and data channels.
- Continuously sequencing LED display provides a diagnostic read out that immediately detects shorts, opens, reversals, and mis-wires at a glance.
- Simply snap-and-lock master and remote units together when not in use.
- Ergonomically designed hand-held unit is lightweight, rugged and impact resistant.

CATALOGUE NUMBER	DESCRIPTION
SLT	Line Tester Coax/UTP
SLTU	Line Tester UTP

CAUTION: DO NOT USE ON LIVE CIRCUITS

CLIPSAL DATACOMMS LIFETIME WARRANTY

Clipsal Datacomms Product and Applications Lifetime Warranty Program

LIFETIME WARRANTY PROGRAM

This warranty specifically applies to Clipsal Datacomms products as defined in the Clipsal Datacomms Product Selection Guide. In order to comply with this warranty the product must be purchased from an Authorised Clipsal Datacomms Distributor, installed by a Clipsal Datacomms Certified Installer/Endorsed Partner and the site must have a certified registered certificate issued by Clipsal Datacomms.

The product warranty covers the passive components that are registered in the Clipsal Datacomms range of products in the Clipsal Datacomms Product Selection Guide. Passive products are those not requiring energy or exhibiting gain.

The Clipsal Datacomms products are free from manufactured defects in material or workmanship under normal and proper use. All Clipsal products including the entire Clipsal Datacomms installation meet or exceed the relevant AS/NZS 3080:2003 Standard.

The product warranty is only applicable to the original site of installation and Clipsal Datacomms will either replace or repair the defective product. Clipsal Datacomms will replace product either itself or through one of its Clipsal Datacomms Certified Installer/Endorsed Partners – including labour.

Lifetime expressly refers to the operation of the product in the original site of installation and is owned by the original end user as listed on the Clipsal Datacomms Product and Applications Assurance Warranty issued by Clipsal Datacomms.

APPLICATIONS ASSURANCE

This directly refers to the application as listed on the Clipsal Datacomms Product and Applications Assurance Certificate. Clipsal Datacomms guarantees the stated application on the warranty will operate for the lifetime of the site.

The Applications Assurance is only applicable to the original site of installation and Clipsal Datacomms will either replace or repair defective product. Clipsal Datacomms will replace product either itself or through one of its Certified Installer/Endorsed Partners – including labour. It will ensure that the site is returned to support the original application as listed on the original Clipsal Datacomms Product and Applications Assurance Warranty. In the event that the Category of product is no longer available, Clipsal Datacomms will provide the next highest rated product available. The reinstall will only cover the defective product and not the replacement of the entire system.

The Assurance Program also covers any applications in accordance with recognised standards from either EIA/TIA or ISO 11801 that apply to the originally installed system.

Lifetime expressly refers to the operation of the product in the original site of installation and is owned by the original end user as listed on the Clipsal Datacomms Product and Applications Assurance Warranty issued by Clipsal Datacomms.

CLAIMS

In the event of a claim for a site, the end user must determine the site application that fails due to the cabling system, the end user must notify Clipsal Datacomms. Clipsal Datacomms will verify the claim and determine a resolution to the claim.

If the investigation shows that the site cabling is not the cause of failure of operation, Clipsal Datacomms reserves the right to charge a site visit fee to recover costs of that visit.

COVERAGE

This lifetime warranty is only for the benefit for the original end user purchaser as listed on the Clipsal Datacomms Product and Applications Assurance Warranty.

MOVES AND ADDITIONS

All additions must be fully documented to Clipsal Datacomms and must be carried out by an Authorised Clipsal Datacomms Certified Installer/Endorsed Partner. All product used must be Clipsal Datacomms Product as listed in the Clipsal Datacomms Product Selection Guide. Any other brand of products used will void this warranty and systems assurance completely.

AUDITS

Clipsal will audit each year a percentage of new sites to ensure quality and compliance of the installation.

What is not covered by this warranty?

This warranty does not cover the failure of the installer to follow AS/NZS 3080:2003 guidelines for the appropriate Category of product used in the installation in either design or installation.

As previously mentioned any other product that is not Clipsal Datacomms product as listed in the Clipsal Datacomms Product Selection Guide or any other vendors product will not be covered and if used will void the warranty completely.

Any installation work subsequent to the original installation that is not carried out by a Clipsal Datacomms Certified Installer/Endorsed Partner.

Any installation work subsequent to the original installation that has not been submitted for site amendment and updated certificate issued.

Any accidents, damage in transit, alteration, unauthorised repair, failure to follow instructions, misuse, fire, flood, acts of God, civil unrest or wars.

Any product reinstalled at any site automatically makes this warranty null and void. This warranty does not cover any loss of time, inconvenience, loss of use of the Clipsal Datacomms product or any associated product, property damage caused by failure of the product to work or any other incidental or consequential damages.

FINAL STATEMENT

This warranty and assurance is the only warranty on Clipsal product and it sets forth all Clipsal Datacomms' responsibilities regarding the product. Repair or replacement by Clipsal Datacomms or its Authorised Clipsal Datacomms Certified Installer/Endorsed Partner is the exclusive remedy.

The Clipsal Difference

The Clipsal Datacomms extensive product and applications guarantee program is backed by the National Association of Testing Authorities accredited third party test verification. This ensures that the end user, Engineering Consultant and the Installer have complete peace of mind.

The third party test verification will report on the following:

COPPER REPORTING

- Copied/duplicated test results.
- NVP change.
- Deleted test results.
- Fails.
- Standard/Performance level changes.
- Use of inappropriate adaptors.
- Testing to withdrawn standards.
- Missing tests.

FIBRE REPORTING

- Loss length propagation delay, continuity and polarity.

THE CLIPSAL DIFFERENCE

Unlike other manufacturers, the Clipsal Datacomms Lifetime Warranty includes all of the infrastructure. This incorporates items that are often neglected such as:

- Backbone cabling
- Underground cabling
- Conduit
- Cable tray
- Cabinets.

In fact, any passive device in the structured cabling system is covered by this industry-leading guarantee.

Clipsal Datacomms offers the simplicity and convenience of dealing with one vendor for all of your voice and data communication needs, backed by a product and applications warranty that is second to none in the industry.

**TECHNICAL INFORMATION,
GLOSSARY AND INDEX**

Australian/New Zealand Standard

NETWORK STANDARD: AS/NZS 3080:2003

Telecommunications installations – generic cabling for commercial premises.

- i. Planning and installing of structured wiring systems.
- ii. Cable and cross-connecting hardware specifications, performance and installation requirements.
- iii. Physical star topology.
- iv. Cabling divisions: horizontal and backbone.

HORIZONTAL: THE MAXIMUM CHANNEL LENGTH SHALL BE LESS THAN 100M

- i. Cabling installed between the floor distributor (FD) and the telecommunications outlet (TO).
- ii. Maximum distance of 90m for UTP and fibre from FD to TO, 5m for workstation jumpers and 5m for cross-connect jumpers/patch cords.
- iii. Two wall outlets per workstation
 - One cable must be 4 pair 100 Ohm UTP Category 5e minimum
 - Other cable can be any of the recognised media.
- iv. Recognised media:
 - 4 pair, 100 Ohm UTP
 - 4 pair 100 Ohm ScTP (F/UTP)
 - 50 or 62.5 µm optic fibre.

BACKBONE: THE MAXIMUM CHANNEL LENGTH SHALL BE LESS THAN 2KM AND MAY REQUIRE A MIX OF CABLING MEDIA AND PERFORMANCE

- i. Cabling between building entrance facility, campus/building distributor and floor distributor.
- ii. Conventionally, vertical shaft cable; but also used in a star topology in a campus type network.
- iii. Recognised media:
 - 100 Ohm multipair UTP
 - 100 Ohm multipair ScTP (FTP)
 - 50 or 62.5 µm optic fibre
 - Single mode fibre.

WORK AREA

- i. Cabling extended from telecommunications outlet to work station equipment.
- ii. Work area cord and balun with a maximum length of 5M.

TELECOMMUNICATIONS ROOM(S)

- i. Termination of Horizontal and Backbone cables to be compatible with connecting hardware.
- ii. Recognised media:
 - Patch cord
 - Wire jumper
 - Connecting hardware.

EQUIPMENT ROOM(S)

- i. Provides a controlled environment to house telecommunications equipment and protection apparatus where applicable.

Twisted-Pair Performance

PERMANENT LINK AND CONSOLIDATION POINT (CP) LINK MODEL

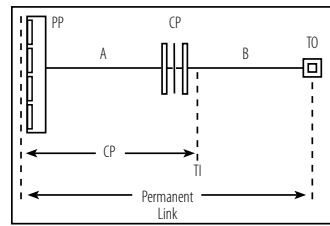

LEGEND

- PP = Patch Panel
- TO = Telecommunications Outlet
- TI = Test Interface Point
- CP = Consolidation Point

- The cabling under test in configuration A is termed the CP link. This configuration is cabled with fixed cabling only.
- The cable under test in configuration A + B is termed the permanent link. This configuration is cabled with fixed cabling only.
- The consolidation point (CP) shall only contain passive connection hardware, which shall be located so there is at least 15m from it to the floor distributor.

CHANNEL MODEL

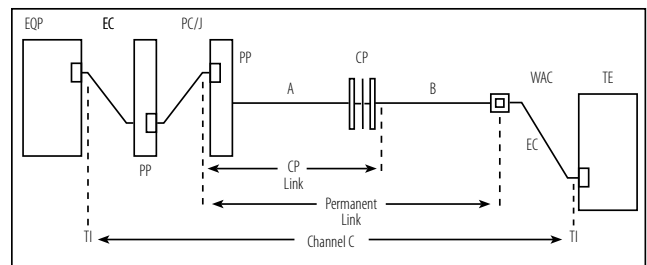

LEGEND

- EQP = Equipment Patch Panel
- EC = Equipment Cord
- PC/J = Patch Cord/Jumper
- PP = Patch Panel
- TO = Telecommunications Outlet
- TI = Test Interface
- CP = Consolidation Point
- WAC = Work Area Cord
- TE = Telecommunications Equipment

- The cabling under test in configuration C is termed the Channel. This configuration is cabled with fixed cabling and includes the performance of the Equipment Cord, Patch and Jumper Cord, Work Area Cord and the Consolidation Point.

Twisted-Pair Media

The following table defines the AS/NZS 3080: 2003 CLASS (Category) for horizontal copper cables.

CLASS A (CATEGORY 1) AND CLASS B (CATEGORY 2)

These twisted-pair cables are not recognised in the ANSI/TIA/EIA-568-A Standard. Typically used for voice and low speed data (9600 b/s or less) transmission rates. The characteristics of these cables are specified up to 100KHz and 1 MHz respectively.

CLASS C (CATEGORY 3)

This designation applies to twisted-pair cable and connection hardware currently specified in the AS/NZS 3080: 2003 Standard. The characteristics of these cables are specified up to 16MHz. They are typically used for voice and data transmission rates up to 10Mb/s (e.g. IEE 802.5 4Mb/s twisted-pair annex and IEE 802.3 10Base-T).

CLASS D (CATEGORY 5)

The characteristics of these twisted-pair cable and components are specified up to 100MHz. They are intended to be used for voice and data transmission rates up to 1000mb/s. Previously referred to as Category 5e, these products are designed with additional parameters necessary to support application that make use of all four pairs in the cable for simultaneous bidirectional transmission (such as IEEE 802.3 1000BASE-T) Gigabit Ethernet.

CLASS E (CATEGORY 6)

Continued development of high-speed applications drove the need for more bandwidth than Class D cabling systems. Class E channels have a power sum ACR that is greater than zero at 200 Mhz, and parameters are specified up to 250 MHz.

CLASS EA (CATEGORY 6A)

For cable connecting hardware products with transmission characteristics specified to 500 MHz, used to support digital transmission of 10Gbs.

CLASS FA (CATEGORY 7A)

For cable connecting hardware products with transmission characteristics specified to 1200 MHz, used to support digital transmission of 40Gbs.

FTP (SCTP)

The characteristics of these cables and components are defined in terms of impedance and class (category). The cables and components shall have the same nominal impedance i.e: 100Ω for Class A to Class F.

Solid vs. Stranded Cable

UTP SOLID CABLE

For runs between Building Distributor and Floor Distributor to a wall plate, choose regular UTP cable. These solid-conductor cables, designed for horizontal and backbone cable runs, should not be flexed, bent or twisted repeatedly and should be installed in accordance with recommended installation guidelines.

UTP STRANDED PATCH CABLE

Use stranded patch cable for connecting your workstation NICs to the wall plate, with patch panels and with other equipment such as switches. Since it's made with stranded wires, stranded patch cable is excellent for applications that call for repeated flexing without damaging the cable.

Since attenuation is higher in stranded cables than in solid-conductor cables, you should try to keep these cable runs short, to lower the chance of introducing even more attenuation into your system. It's best to keep lengths of stranded patch cables under 5m; if a total cord length of 10m per channel is to be exceeded, then the PL discounting formulae must be applied.

Unshielded vs. Shielded Twisted Pair Cable

In noisy environments such as airports and manufacturing facilities, shielded twisted-pair FTP (SCTP) cable is preferred. These environments contain radio frequency interference (RFI) and/or electromagnetic interference (EMI). The shielding protects the data being transmitted through the cable and it keeps the cable itself from emitting EMI and RFI.

Cables feature the same core and jacket as the widely used Unshielded Twisted Pair (UTP) cables. And they contain a drain wire and foil shield that covers all four pairs. The plugs are also shielded.

STP cables use individually screened pairs with an overall braid shield, which sets them apart from less expensive FTP (SCTP) cables.

Choosing Fibre Type

As a general guideline in premises applications for backbone cabling:

- i. 62.5/125µm or 50/125 µm multi mode optical fibre is recommended for:
 - Distances 2km and under for OM1, OM2 and OM3 optical fibre types in both
 - 850nm and 1300nm wavelengths
 - Data rates to 1000Mb/s and beyond.
- ii. Single-mode fibre is recommended for greater distances or higher data rates:
 - Distances 3km and under for OS1 in both 1310nm and 1550nm wavelengths
 - Data rates up to 10 Gb/s IEEE802.3:10GBASE-LR/LW + ER/EW respectively.

Often a backbone comprised of both multi-mode and single-mode fibre is recommended to satisfy present and future needs in the backbone.

- i. For horizontal cabling, 62.5/125µm or 50/125µm multi-mode optical fibre is recommended for:
 - Distances up to 90m
 - Data rates up to 10 Gb/s.
- ii. For centralised cabling, 62.5/125µm or 50/125µm multi-mode optical fibre is recommended for:
 - Distances up to 300m
 - Data rates up to 10 Gb/s.

Always follow the original equipment manufacturer (OEM) electronic equipment specifications for optical fibre core size when designing an optical fibre telecommunications system. Contact the OEM if:

- Specifications vary from the 62.5/125µm or 50/125µm multi-mode standard
- The fibre is used for a unique application.

The most common identification of fibres is in 12-fibre groups with each group colour coded as follows:

(1). Blue	(5). Grey	(9). Yellow
(2). Orange	(6). White	(10). Violet
(3). Green	(7). Red	(11). Light Blue/Aqua
(4). Brown	(8). Black	(12). Pink.

Note: OM3 multi mode optical fibre can now support 10Gb/s IEEE 802.3: 10GBASE-SR/SW.

Segregation of UTP/STP from Power Cable

When routing UTP cable, maintain the following minimum distances from power source:

- 15cm (6 in.) from powerlines of 2 KVA or less
- 30cm (12 in.) from lighting (including fluorescent)
- 90cm (36 in.) from powerlines of 5 KVA or greater
- 100cm (40 in.) from transformers and motors.

When routing STP cable, maintain the following minimum distances from power source:

- 6.5cm (3 in.) from powerlines of 2 KVA or less
- 15cm (6 in.) from powerlines of 2 KVA or less
- 30cm (12 in.) from lighting (including fluorescent)
- 90cm (36 in.) from powerlines of 5 KVA or greater.

Sequence Options

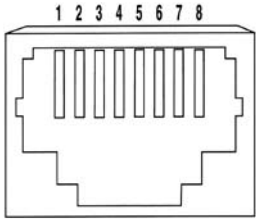

RJ-45 Modular Jack Female

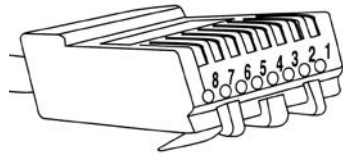

RJ-45 Modular Jack Male

Sequence is defined as the order in which the incoming pairs are terminated into the modular interface pins. Each pair is designated with a transmit conductor and a receive conductor.



10 BASE-T

Used with the WE8W polarisation, this is a modification of the T-568A sequence, leaving pair #1 open and starting with pair #2. This provides an additional level of protection from interconnection of voice and data equipment. If voice equipment is always wired on pins 4 and 5 (pair #1), and data equipment never has pins 4 and 5 active, no interconnection is possible.

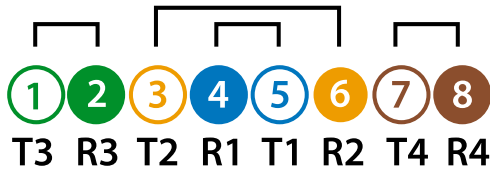

T-568A

This is the preferred connection sequence for Australia and New Zealand as stated in AS/NZS 3080-2003; also the EIA Commercial Cabling Specification for termination of UTP data cable. The international standard for ISDN also states this standard. This is similar to the T-568B sequence except that pairs #2 and #3 are transposed.

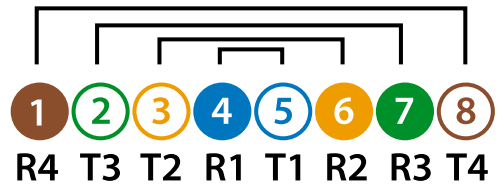

T-568B

This is the legacy connection sequence for the U.S. and is derived from IEEE 802.3 10 Base-T Ethernet over twisted pair. This standard is only applicable to eight wire polarisation (WE8W).

USOC (UNIVERSAL SERVICE ORDER CODE)

Historically the most common sequence, and is used by U.S. telephone systems. Pairs are 'nested', i.e. pair #1 is centred, pair #2 is the next two contacts out, etc. This maintains pair-to-pair continuity when, for instance, one pair equipment is connected through a 4 pair circuit. Nesting of pairs also enables a reversal to be made within each pair through the use of simple 'reversing' line cord (1 to 8, 2 to 7).

USOC is applicable to WE2W, WE4W, WE6W and WE8W polarisations. An advantage of the pair nesting of the USOC sequence is that a WE4W/6W plug inserted into a WE8W jack works fine as long as quality (correctly tolerated) components are used.

Note: USOC pin/pair sequences are rarely used outside of North America.

Glossary

°C	Degrees Celsius.	Balanced Coupler	A coupler having an even ratio of power splits i.e. 1X4-25/25/25/25.
10BASE-T	An implementation of the Institute of Electrical and Electronic Engineers (IEEE) Ethernet Standard on 24-AWG, unshielded, twisted-pair wiring, a baseband medium of 10Mb/s.	Bandwidth	The range of frequencies that can be used for transmitting information on a channel. It indicates the transmission – carrying capacity of a channel. Thus, the larger the bandwidth, the greater the amount of information that can pass through the circuit. Measured in Hertz MHz km (for fibre) or MHz.
100BASE-T	Official project name for 100 Mb/s Fast Ethernet on Class C.	Bend Loss	A form of increased attenuation caused by either having the fibre curved around a restrictive radius of curvature, or microbends caused by minute distortions in the fibre imposed by externally induced perturbations. Excessive bend loss may result from poor drawing or cable manufacturing techniques.
100BASE-TX	100 Mb/s Fast Ethernet using 2-pair Category 5 cable.	Bend Radius	The radius of curvature that fibre or copper can bend without breaking or causing excessive loss.
1000BASE-T	A specification for Gigabit Ethernet over copper wire (IEEE Standard 802.3ab). The standard defines 1 Gb/s data transfer over distances of up to 100 metres using four pairs of Class D balanced copper cabling and a 5-level coding scheme.	Bidirectional	The movement of signals in opposite directions through a common cable.
1000BASE-TX	A specification for Gigabit Ethernet over copper wire (TIA/EIA). The standard defines 1 Gb/s data transfer over distances of up to 100 metres using four pairs of Category 6 balanced copper cabling.	Broadband	Networks in which the bandwidth can be shared by multiple simultaneous signals that are encoded using modulation techniques.
10GBASE-LX4 ER/EW, SR/SW LR/LW	IEEE specification of 10 Gigabit Ethernet over optical fibre cabling, with specifications for Multi Mode and Single Mode fibre.	Buffer	The plastic material that surrounds the core and cladding of an optical fibre strand. This coating adds strength and flexibility to the fibre strand. Typically 250µm in size.
802.3	Defined by the Institute of Electrical and Electronic Engineer (IEEE), these standards govern the use of the Carrier Sense Multiple Access/Collision Detection (CSMA/CD) network access method used by Ethernet networks.	Cable Assembly	Cable that has connectors installed on one or both ends. General use of these cable assemblies includes the interconnection of cable systems. If connectors are attached to only one end of the cable, it is known as a Pigtail. If connectors are attached to both ends, it is known as a jumper or patch cord.
802.5	Defined by the Institute of Electrical and Electronic Engineer (IEEE), these standards govern the use of the token ring network access method.	Cable Fill	The ratio of cable installed into a conduit/trunking against the theoretical maximum capacity of the conduit/trunking.
802.11	Defined by the Institute of Electrical and Electronic Engineer (IEEE), these standards govern the use of wireless LANs.	Cabinet	A physical enclosure for rack-mount equipment; standard cabinets have 19" wide horizontal spacing between mounting rails.
A	see Ampere (A).	Cabling	A system of telecommunication cables, cords and connecting hardware that can support the connection of information technology equipment.
Adaptor	A device that: (1) enables different sizes or types of plugs to mate with one another or to fit into an information outlet, (2) provides for the rearrangement of leads, (3) allows large cables with numerous wires to fan out into smaller groups of wires, or (4) makes interconnections between cables.	Capacitance	The property in a system of conductors and dielectrics that permits the storage of electrically separated charges whenever a difference in potential exists between the conductors. Capacitance is undesirable in copper wire cable because it interferes with signals travelling on the wire by opposing the desired flow of current.
American National Standards Institute (ANSI)	ANSI is the principal group in the United States for defining standards. ANSI represents the U.S in the International Standards Organisation (ISO).	Category 3	For cable and connecting hardware products with transmission characteristics specified to 16 MHz, typically used to support digital transmission of 10Mb/s.
American Wire Gauge (AWG)	The standard gauge for measuring the diameter of copper, aluminium, and other conductors.	Category 5e	This is an enhanced version of Category 5, with additional parameters specified to enable parallel transmission with full duplex across the four pairs. Enhanced Category 5 specifications for cable and connecting hardware products with transmission characteristics specified to 100 MHz, intended to support digital transmission of 1000 Mb/s.
Ampere (A)	A standard unit of current. One ampere of current is produced by one coulomb of charge passing a point in one second.	Category 6	For cable and connecting hardware products with transmission characteristics specified to 250 MHz, used to support digital transmission of 1 Gb/s and above.
Analogue Transmission	A method of signal transmission in which the shape of the signal is a continuously variable and directly measurable physical quantity.	Category 6A	For cable and connecting hardware products with transmission characteristics specified to 500 MHz, used to support digital transmission of 10 Gb/s.
ANSI	see American National Standards Institute (ANSI).	Category 7A	For cable and connecting hardware products with transmission characteristics specified to 1200 MHz, used to support digital transmission of 40 Gb/s.
ANSI/TIA/EIA 568B	North American Commercial Building Telecommunications Wiring Standard.	CATV	An acronym for cable television, derived from Community Antenna Television.
Asynchronous Transfer Mode (ATM)	ATM is a high speed (155Mbps/622Mb/s) cell relay, switching and transport technology for either local or wide area environments.		
Attachment Unit Interface (AUI)	Most commonly used with reference to the 15 pin D type connector and cables used to connect single and multiple channel equipment to an Ethernet transceiver.		
Attenuation	The effect of signal reduction, experienced with accumulation line length or distance of radio transmission.		
Attenuator	A device inserted into the electrical or optical path to lessen or weaken the signal.		
Australian Standard /New Zealand (AS/NZ)	Joint Australian and New Zealand standards.		

Glossary

Central Processing Unit (CPU)	The key component of a computer system, which contains the circuitry necessary to interpret and execute program instructions.	Data Communication Equipment (DCE)	General terminology for data communication equipment such as modems. A device that terminated a data communication session and provides encoding or conversion if necessary. See also Data Terminating Equipment (DTE).
Characteristic Impedance	A frequency-dependant resistance that quantifies the complex opposition to current flow offered by a transmission line. (Expressed as Z° and typically 100 – 2).	Data Terminating Equipment (DTE)	The term used to describe any type of computer or other equipment, when connected to a data communication network.
Circuit	A two-way communication path between electronic devices.	Decibel (dB)	A unit used to measure relative increase or decrease in power, voltage or current using a logarithmic scale.
Cladding	The low refractive index material that surrounds the core of an optical fibre, usually pure silica (typically 125 μ m).	Delay Skew	Delay skew is the difference in propagation delay between pairs within the same cable sheath.
Client-Server	A technique by which processing can be distributed between nodes requesting information (clients) and those maintaining data (servers).	Dielectric	A non-conducting or insulating material that resists passage of electric current.
Coating	A protective layer of material over the cladding of an optical fibre (typically 250 μ m).	Dielectric Cable	A non-conducting cable, such as fibre optic cable, without metallic members.
Coaxial Cable (Coax)	A cable with a centre conductor surrounded by thick dielectric, surrounded by a conductor made of metal braid. An outer jacket insulation is optional.	Dielectric Constant	The ratio of the capacitance of the insulated wire to that of the same wire uninsulated in air.
Composite Cable	A cable construction technique that combines multiple cables or media in a single overjacket.	Dielectric Strength	A measure of the maximum voltage that the insulation of a particular cable can withstand without breakdown.
Conductor	A medium such as copper wire that can carry electrical current.	Digital Signal	A signal that represents information by a series of fixed, encoded, rectangular pulses, usually consisting of two possible voltage levels. Each voltage level indicates one of two possible values or logic states, such as on or off, open or closed, true or false.
Conduit	A pipe, usually metal, that runs underground from floor to floor, or along a floor or ceiling, to protect cables. In Riser Backbone Subsystems, when riser telecommunication closets are not aligned, conduit is used to protect cable and provide the means for pulling cable from floor to floor. In the horizontal Subsystem, conduit may be used between a telecommunication closet and an information outlet in an office or other room. Conduit is also used for in-conduit campus distribution, where it is run underground between buildings and intermediate manholes and is made of plastic encased in concrete.	Digital Transmission	A technique in which all information is converted into binary digits for transmission.
Connecting Block	A flame-retardant plastic block containing metal wiring terminal (IDC's) that establishes an electrically tight connection between the cable and the cross-connect wire.	Dispersion	The tendency of light to spread out and lose its focus in fibre optic cables.
Connector	A device that allows you physically to connect and disconnect copper wires or fibres to cable equipment or to other wires or fibres. Copper wire and fibre optic connectors must often join transmission media to equipment or cross-connects.	Distributor	The term used for the function of a collection of components (for example, patch panels, patch cords) used to connect cables.
Core	The central transmission area of fibre. The core always has a refractive index higher than that of the cladding.	Drop cable	The coaxial cable that connects the feeder portion of the distribution system to the subscriber's premises.
Cords	A short length of copper wire or fibre optic cable with connectors on each end. Used to connect equipment to cabling, or to connect cabling segments (cross-connection).	Duplex	A duplex cable contains two fibres, a duplex connector links two pairs of fibres.
Coulomb (C)	A quantity of electricity transferred by a current of one ampere in one second.	EIA/TIA	North American Standards organisation.
Coupling	Transfer of light into or out of an optical fibre. Note: that coupling does not require a coupler.	EIA/TIA 568B	North American Commercial Building Telecommunications Wiring Standard.
Coupler	A device that connects three or more fibre ends, dividing one input between two or more outputs or combining two or more inputs into one output.	EIA/TIA569A	North American commercial building standard for telecommunication pathways and spaces. Its purpose is to standardise specific cabling accommodation practices within and between buildings which are in support of telecommunication media and equipment.
CPU	See Central Processing Unit (CPU).	EIA/TIA 606A	North American administration standard for the telecommunications infrastructure of commercial buildings. Its purpose is to provide guidelines for a uniform administration scheme for the cabling infrastructure.
CRC	See Cyclic Redundancy Check (CRC).	Electromagnetic Compatibility (EMC)	The ability of a system, equipment or device to operate satisfactorily in its environment without introducing unacceptable electromagnetic disturbance, or being affected by that environment.
Cross Connect	A facility enabling the termination of cable elements and their interconnection, primarily by means of Patch Cords or jumpers.	Electronics Industries Association (EIA)	North American Electronics Association.
Crosstalk	An electromagnetic coupling between two physically isolated circuits in a system. This coupling causes a signal on one circuit to induce a noise voltage on adjacent circuits, thereby causing signal interference.	Electromagnetic Flux	Electric and magnetic fields (commonly referred to as emission) generated by equipment or system.
Cyclic Redundancy Check (CRC)	A coded sequence of information allowing error checking and correction.	Electromagnetic Interference	The interference in signal transmission or reception caused by the radiation of electric and magnetic fields (EMI).
		EMC	See Electromagnetic Compatibility.
		EMI	See Electromagnetic Interference.

Glossary

EN 50173	The European standard for generic cabling for customer premises similar to ISO/IEC 11801.	Fibre Optic Interconnect	It provides interconnection for individual optical fibre but, unlike the fibre optic cross-connect panel, it does not use patch panel cords or jumpers. The fibre optic interconnect provides some capability for routing and re-routing circuits, but is usually used where circuit rearrangements are infrequent.
EN 50174	A proposed European cabling system planning and installing standard developed by CENELEC similar to EIA/TIA 569A.	Fibre Optic Splice	A fibre optic cable splice is used to join together two fibre optic cable ends permanently (mechanical or fusion).
Equal Level Far End Crosstalk (ELFEXT)	Is the same as FEXT, except that the coupled signal at the remote end is relative to the attenuated signal at the remote end.	Foil Screened Twisted Pair Cable (FTP)	A cable that uses a metallic foil to surround the conductors in a Twisted Pair Cable. FTP is used mostly by the ISO/IEC. USA uses 5cTP.
Equipment Cable	A cable connecting equipment to a distributor.	Frame	A metallic structure for hanging switch hardware.
Equipment Room	The room in which voice and data common equipment is housed, protected, and maintained and where circuit administration is done using distribution cross-connects.	Frequency	The number of cycles completed by a signal in one second: measured in Hertz (Hz).
Equipment Subsystem	The part of a premises distribution system that includes the cable and distribution components in an equipment room and that interconnects system-common equipment, other associated equipment, and cross-connects.	FTP	See Foil Screened Twisted Pair Cable.
Ethernet	The common name for the most widely used local area network (LAN), generally conforming to the Institute of Electrical and Electronic Engineers (IEEE) 802.3 Standard.	Full Duplex	In contrast to half-duplex devices, full duplex ones allow permanent, simultaneous two-way transmission of information, without interaction or interference of receive and transmit signals.
ETL	Electrical Testing Laboratory (US).	Fusing	The actual operation of joining fibres together by fusing or melting (e.g. fusion splicing).
Far End Crosstalk (FEXT)	Refers to the undesired coupling of signals from the transmit pair onto (FEXT) the receive pair at the other (=far) end. FEXT loss is also expressed in dB. For some applications this is an important parameter; for most applications, however, the NEXT values are more important.	Gauge	A measure of a conducting wire's physical size; usually referred to as AWG (American Wire Gauge). See also American Wire Gauge (AWG).
Fast Ethernet	Fast Ethernet A 100 Mb/s LAN Based On CSMA/CD Protocol. See 100BASE-T.	Graded-Index Fibre	Fibre design in which the refractive index of the core is lower toward the outside of the fibre core and increases toward the center of the core allows light to travel faster in the lower index of refraction region. This type of fibre provides high bandwidth capabilities.
Federal Communication Commission (FCC)	A board of five commissioners, appointed by the president (U.S.), that regulates all electronic communications systems originating in the United States, including telephone systems.	Half Duplex	A telecommunication device allowing two-way transmission of signals or other information, but only in one direction at a time. Thus, a half-duplex device cannot simultaneously transmit and receive, though interspersed burst in each direction are possible.
Ferrule	The alignment sleeve portion of an optical connector.	Headend	The central facility where signals are combined and distributed in a cable television system.
Fibre	Any filament or fibre that guides light. See also fibre optics.	Hertz (Hz)	The standard unit of frequency; equal to one cycle per second.
Fibre Channel	This is an ANSI standard describing point and switched point to point physical interface, transmission protocol, signalling protocol, services and command set mapping of a high performance serial link for uses between mainframe computers and computer peripherals.	Horizontal Cable	A cable connecting the floor distributor to the telecommunications outlet(s).
Fibre Distributed Data Interface (FDDI)	An American National Standards Institute (ANSI) standard for a fibre-based token ring physical and data link protocol that operates at a 100 Mb/s data transfer rate.	Insulation Displacement Contact (IDC)	A type of wire terminating connection, in which the insulating jacket is cut by the connector when the wire is inserted.
Fibre Optic	A fibre optic cable in which individual optical fibres are formed into a cable.	Institute of Electrical and Electronic Engineers (IEEE)	This organisation is also involved in producing Local Area Network standards such as Ethernet and Token Ring.
Fibre Optics	A technique of conveying light or images through glass or plastic fibres.	Insertion Loss	The amount of signal loss (attenuation) as the signal passes through a connection, interface, or channel.
Fibre Optic Cable	A transmission medium consisting of a core of glass or plastic surrounded by a cladding, strengthening material and outer jacket. Signals are transmitted as light pulses, introduced into the fibre by a light transmitter either a laser or light-emitting diode (LED). Some of the advantages offered by fibre optic cable are low data loss, high speed transmission, large bandwidth, small physical size, light weight, and freedom from electromagnetic interference and grounding problems.	Insulation	A material having high resistance to flow of electric current. Thin conducting wires are covered with colour coded insulation for protection.
Fibre Optic Connectors	Connectors designed to connect and disconnect either single or multiple optical fibres repeatedly. Fibre optic connectors are used to connect fibre cable to equipment and interconnect cables.	Insulation Resistance	The measure of ability of an insulation material to resist the flow of current through it; usually measured in Megohm.
Fibre Optic Cross-Connection	Fibre optic apparatus for terminating cable. Designed for high-density cross-connection fields, the apparatus can terminate multiple fibres on each shelf. Single shelves can also be wall mounted. Cross-connections are handled with fibre optic Patch Cords. See also Patch Cords.	Interconnect	A circuit administration point, other than a cross-connect or information outlets, that provides capability for routing and re-routing circuits. It does not use patch cords or jumpers. Typically, it is a jack and plug device used in smaller distribution arrangements or to connect circuits in large cables to those in smaller cables.
		Interference	A signal impairment caused by the interaction of another unwanted signal.

Glossary

Integrated Services Digital Network (ISDN)	A CCITT standard providing switched end to end simultaneous handling of digitised voice and data traffic.	Modulation	Coding of information onto the carrier frequency. This includes amplitude, frequency or phase modulation techniques.
International Standard Organisation (ISO)	The organisation responsible for the Open Systems Interconnect (OSI) Standards.	Multifibre Cable	An optical cable that contains two or more fibres, each of which provides a separate information channel.
Interoperability	The ability to operate and exchange information in a heterogeneous network.	Multi Mode	Many light rays (modes) propagating through the fibre core.
ISO/IEC 11801	An international standard for generic cabling for customer premises (AS/NZS 3080 is derived from this standard).	Multi Mode Fibre	Optical Fibres that have a large core and that permit non-axial rays or modes to propagate through the core. 62.5 or 50 micron are the common standard core sizes for premises cabling systems.
ISO/IEC 14763-1	The international standard for basic administration of generic cabling.	Multiplexing	The process of combining multiple signals, usually by time-division multiplexing (TDM) on a high-frequency carrier, to optimise the use of available transmission media.
Jack	A receptacle used with a plug to make electrical contact between communications circuits. Jacks and their associated plugs are used in a variety of connecting hardware applications including adaptor, information outlets, and equipment connections.	Nanometre (nm)	A unit of length in the metric system denoting one-billionth of a metre (10nm). Measure of wavelength.
Jacket	The flexible covering of a cable, used to protect the colour coded conductors inside.	NATA	National Association for Testing Authorities.
Jumper	A cable unit or cable element without connectors, used to make a connection on a cross-connect.	Near End Crosstalk (NEXT)	Refers to the undesired coupling of signals from the transmit pair onto the receive pair on the same (near) end. NEXT isolation is expressed in dB and is a measure of how well the pairs in a cable are isolated from each other.
Jumper Wire	A short length of copper wire used to route a circuit by linking two cross-connect termination points.	Network	The local and long-distance telecommunications capability provided by common carriers for switch and private line telecommunications services.
Kevlar	An aramid yarn used to provide crush resistance and pulling strength in a fibre cable. Kevlar is a trademark of the Du Pont Company.	Network Architecture	Network topology and design.
LAN	See Local Area Network.	Network Interface	The point of interconnection between building communications wiring and outside communications lines (telephone company facilities, e.g. MDF).
Link	The transmission path between any two interfaces of generic cabling. It excludes equipment cable and work area cables.	Network Interface Card (NIC)	The piece of equipment that is installed into the expansion port of a personal computer and allows communication between the PC and the network.
LIU	Live interface unit.	Node(s)	A piece of communication equipment on the network.
Laser	A device that amplifies light waves and concentrates them in a narrow, very intense beam.	Noise	The term used for spurious signals produced in a conductor by sources other than the transmitter to which it is connected. Noise can affect a legitimate signal to the extent that it is inaccurate or indecipherable when it reaches the receiver. The higher the speed of data transmission, the worse the effects of noise become.
Light Emitting Diode (LED)	A device used in a transmitter to convert information from electric to optical form. It typically has a large spectral width.	Numerical Aperture	The number that expresses the light gathering ability of a fibre.
Local Area Network (LAN)	A data communication network consisting of host computers or other equipment interconnected to terminal devices, such as personal computers, often via twisted-pair or coaxial cables. LANs allow users to share information and computer resources. Typically, a network is limited to a single premises.	Ohm(w)	The standard unit of electrical resistance. One volt will cause one ampere of current to flow through one ohm of resistance.
Loose Tube	A protective tube loosely surrounding a fibre is often filled with gel for external plant applications.	Open System Interconnection (OSI) (Model)	The model describes the seven layer process of communication between 'co-operating' computers. The model provides a standard for the development of communication protocols allowing for computers of different manufacturers to be interconnected.
Macrobanding	Excess bending in fibre.	Optical Connectors	See Fibre Optic Connectors.
Mechanical Splicing	One of several available devices for splicing fibres in lieu of fusion splicing. Mechanical splices are primarily designed for any environment where a permanent, low loss joint is required.	Optical Fibre	A transmission medium consisting of a core of glass or plastic surrounded by a cladding. Signals are transmitted as light pulses, introduced into the fibre by a light transmitter i.e. Laser or an LED.
Megabit (Mb)	One million binary bits.	Optical Time-Domain Reflectometre (OTDR)	An instrument that characterises cable loss by measuring the amount of injected light as a function of time. It is useful for estimating attenuation and for locating splices, connecting and break.
Megabits per second (Mbps)	Rate of data transmission.	Outlets	A term used to describe the sockets provided in the work location of a Structured Cabling System. These are usually eight pin modular sockets which can support a variety of service e.g. voice, video and data (e.g. RJ45).
Megahertz (MHz)	One million hertz (cycles per second).	Pair	Two wires (usually twisted) together and marked with reciprocal colour coding. See also Twisted Pair.
Microbanding	Bends in the fibre, usually of a radius less than 1mm, that cause a localised increase in the loss of the fibre due to the leaking of light through the core-cladding interface.		
Micron (µm)	A micrometre; one-millionth of a metre.		
Modem	A modulator / demodulator unit used for data transmission. It converts digital data into analogue tones when transmitting over standard voice-grade telephone lines and reverses this process when receiving.		

Glossary

Passive Device	A static device that requires no power for its intended function.
Patch Cord(s)	A short length of copper wire or fibre optic cable with a connector on each end used to join communication circuits as a cross-connect.
Patch Panel(s)	A cross-connect designed to accommodate the use of patch cords. It facilitates administration for moves and changes.
PCB	Printed Circuit Board.
Pigtail	Fibre optic cable that has connectors installed on one end. See also Cable Assembly.
Plenum Cable	Cable specifically designed for use in a plenum, the space above a suspended ceiling used to circulate air back to the heating or cooling system in a building. Plenum cable has insulated conductors often jacketed with TEFLON or HALAR on the copper and low smoke PVC on fibre optics to give them low flame-producing and low smoke producing properties.
Polyvinyl Chloride (PVC)	A flame-retardant thermoplastic insulation material that is commonly used in jacks or building cables.
Port	The cable terminations in the equipment system at which various types of communication devices, switching equipment, and other devices are connected to the transmission network.
Power Sum	A method of testing and measuring crosstalk in multi-pair cables that accounts for the sum of crosstalk affecting a pair when all other pairs are active.
Primary Rate Interface (PRI)	ISDN standard interface comprising 23 B+1D Channel for North America, and 30B+1D Channel for Europe. See Basic Rate Interface (BRI) and Integrated Services Digital Network (ISDN).
Propagation Delay	A signal travelling from end to end of a link is delayed in time by an amount equal to the length of cable divided by the velocity of propagation for that transmission medium. The delay is called Propagation Delay.
Protocol(s)	A rule of procedure by which computer devices intercommunicate. Thus a protocol is the equivalent of a human language, with punctuation and grammatical rules.
Pulling Tension	The amount of pull placed on a cable during installation. Expressed in Newton-metres or foot-pounds.
Registered Jack (RJ)	Acronym describing Modular Jacks in 4 (RJ11), 6 (RJ12) and 8 (RJ45) wire versions.
Riser Backbone Subsystem	The part of a premises distribution system that includes a main cable route and structure for supporting the cable from an equipment room (often in the building basement) to the upper floors, or along the same floor. It is terminated on a cross-connect in a telecommunications room, at the network interface, or at distribution components of the Campus Backbone Subsystem. The Riser Backbone Subsystem usually extends from an equipment room (often in a building's basement) to the upper floors in a multistorey building, or along the same floor in a low-rise building. It is terminated on a cross-connect in a riser telecommunication room, at the network interface, or on the distribution components of the Campus Backbone Subsystem.
Riser Cable	Used in applications for indoor cables that pass between floors. It is normally used in a vertical shaft or space.
Router(s)	A router can be used to connect networks with similar protocols (802.5 token ring local area network [LANs] or dissimilar Open System Interconnection (OSI) model protocols (802.5 token ring LANs and X.25 packet-switching networks). Routers are more sophisticated than bridges and can be used to prevent some of the speed mismatch, security and reliability problems that occur in large networks. An intermediate system between two or more networks capable of forwarding data packets at the network layer (layer three).
Serial Data Transmission	Data transmission between computer devices using only a single circuit path. Whole bytes of information (eight bits) are sent in sequential pattern.
Serial Port(s)/ Transmission	Normally a DB 9 pin connector located on the motherboard of a PC. A technique in which each bit of information is sent sequentially on a single channel.
Server(s)	Host computer(s).
Sheath	A common term for the jacket over twisted pairs of multi pair cables.
Shield	The metallic layer that surrounds insulated conductors in shielded cable. The shield may be the metallic sheath of the cable or the metallic layer inside a non-metallic sheath.
Shielded Twisted Pair Cable (STP)	A cable comprising of one or more elements each of which is individually shielded. There may be an overall shield in which case the cable is referred to as a shielded twisted pair cable with an overall shield.
Simplex	A transmission means allowing only one direction of transmission.
Single Mode	Optical fibre with a small core diameter in which only single mode is capable of propagation. 8.3 micron is the common standard core size.
Sleeves	Short length of rigid metal pipe, approximately four inches (10.0cm) in diameter, located in riser telecommunication rooms that allows cables to pass from floor to floor when rooms are vertically aligned. Sleeves also provide for easy pulling of cable.
Slots	Opening in the floor of riser telecommunications closets that allow cables to pass through from floor to floor when rooms are vertically aligned. A slot accommodates more cable than an individual sleeve.
Splice	The physical joining of two or more copper wire or optical fibres.
Splice Closure	A container used to organise and protect splice trays.
Splitter	Another name for coupler. See also coupler.
Splitting Ratio	The ratio of power emerging from multiple output ports of a coupler.
Straight-Tip (ST) Connector	A fibre optic connector.
Stranded Cable	A strong, woven copper wire used to support cable in aerial distribution systems. The cable is lashed to the stranded cable during installation.
Structured Cabling	Cabling scheme which allows rapid reconfiguration for office moves through patching.
Surge	A sudden voltage rise and fall in an electrical circuit.
Telecommunication Closet/Room	An enclosed space for housing telecommunication equipment, cable terminations, and cross-connect cabling. The telecommunications closet is a recognised cross-connect point between the backbone and horizontal cabling subsystems.
Telecommunication Outlet	A connector where the horizontal cables terminate in the work area.
Thick coax	The transmission medium used for Ethernet or IEEE 802.3 10Base5 LANs. It is a 50 ohm thick coax cable (commonly referred to as the thick yellow cable).
Thin coax	The transmission medium used for IEEE 802.3 10Base2 LANs (sometimes referred to as CheaperNet). It is a 50 ohm thin coax cable.
TIA/EIA	North American Standards Organisation.
TP-PMD	Twisted Pair Physical medium dependent. A twisted pair version of the FDDI standard that allows 100Mb/s transmission over Category 5 copper.

Glossary

Transport Control Protocol/Internet Protocol (TCP/IP)	A common network layer and transport layer data networking protocol.
Transport Layer	Layer four of the OSI model. The transport layer provides for end-to-end data relaying services across any type of data network and is responsible for end-to-end reliability.
Twisted Pair(s)	Two insulated copper wires twisted together. The twists, or lays, are varied in length to reduce the potential for signal interference between pairs. In cables greater than 25 pairs, the twisted pairs are grouped and bound together in a common sheath. Twisted pair is the most common type of transmission media. Often referred to as balanced twisted pairs.
UL	Underwriters' Laboratories, Inc.
Uniformity	The variation of power level between the optical outputs of a splitter.
Unshielded Twisted Pair (UTP) Cable	Normal copper building cable, capable of high-speed data transmission.
Volt (V)	The standard unit of electromotive force or electrical pressure. One volt is the amount of pressure that will cause one ampere of current to flow through one ohm of resistance.
Watt (W)	A unit of power equal to one joule per second.
Wavelength	The physical distance of one electromagnetic wave cycle.
Wavelength Division Multiplexer (WDM)	A passive device that transmits signals at different wavelength through the same fibre.
Wide Area Network (WAN)	Any physical network topology that spans large geographic distances. WANs usually operate at lower speeds and have higher delays than local area networks (LANs).
Wireless LANs	Local area network that communicates using radio technology.
Wiring Closet	See Telecommunication Closet/Room.

Index by Catalogue Number

2000/2	40, 56	2T100PIPV	19	3100RB50	14	3106CAB45C924	139
2000/3	40, 56	2T100POJPEBN6	23	3100RJA5V	14, 63, 214	3106CAB45F100	150
2000/4	40, 56	2T100POJPN6	24	3100VCM10C	7	3106CAB45F1024	155
2000H2	40, 56	2T100POJPP4	22	3100VDM10C	7	3106CAB45F110	151
2000H4	40, 56	2T10PIPV	19	3100VDM10C2	7	3106CAB45F1124	156
2031VH	84	2T10POJPEBN6	23	3100VEM10	7	3106CAB45F120	152
2031VRJA5	85	2T10POJPN6	24	3104A250/1	63	3106CAB45F1224	157
2031VRJT	85	2T10POJPP4	22	3104M8/3	63	3106CAB45F60	147
2032VH	84	2T20PIPV	19	3104PBE13F	62	3106CAB45F80	148
2032VRJA5	85	2T25PIPV	19	3104PBE35F	62	3106CAB45F824	153
2033VH	84	2T2CIGW5	15	3104PBE4L	63	3106CAB45F90	149
2034VH	84	2T2CIRW5	15	3104PBE8,IV	61	3106CAB45F924	154
2035VH	84	2T2PIPV3B	18	3104PBE8P6,BU	61	3106CAS4100HD	180
2036VH	84	2T2POJN6	21	3104PBE8P6,GY	61	3106CAS4110HD	180
224/1	40, 56	2T2POJPE4	20	3104PBE8P6,YL	61	3106CAS4120HD	180
224/2	40, 56	2T30POJPEBN6	23	3104PBEFL	63	3106CAS60HD	180
240/1000BU	210	2T30POJPN6	24	3104PBELL	63	3106CAS60LD	180
240/1000CL	210	2T30POJPP4	22	3104PBEMC	63	3106CAS76LD	180
240/125BU	210	2T3PIPV3B	18	3104PL1/2	64	3106CAS80HD	180
240/125CL	210	2T50PIPV	19	3104PL1/3	64	3106CAS90HD	180
240/250BU	210	2T50POJPEBN6	23	3104PL1/5	64	3106CD55/100	187
240/250CL	210	2T50POJPN6	24	3104PL2/3	64	3106CD85/160	187
240/250GR	210	2T50POJPP4	22	3104PL2/5	64	3106CN	180
240/500BU	210	2T6PIPV	19	3104PL2RJ1	64	3106CT12U15	180, 188
240/500CL	210	30PID	86	3104PL2RJ2	64	3106CT12U30	180, 188
240A	210	30PIDA4L	86	3104PL2RJ4	64	3106CT18U15	180, 188
260/16	197	30RJ45SMA5	30	3104PL4/1	64	3106CT18U22	180, 188
260/20	197	30RJ45SMA5SH	32	3104PL4/3	64	3106CT18U30	180, 188
260/25, GY	197	30RJ45SMA6	46	3104PL4/4	64	3106CT27U15	180
260/32	197	30RJ45SMA6A	70	3104PL4RJ1	64	3106CT27U22	180
260/40	197	30RJ45SMA6AS	72	3104PL4RJ3	64	3106CT39U15	180
260/50	197	30RJ45SMA6SH	48	3104PL4RJ5	64	3106CT39U22	180
2D4P5IPV3B	37	30RJ64SM	6	3106AMD18	185	3106CT45U15	180
2D4P5IPV5B,BU	37	30RJ64SMT	6	3106AMD27	185	3106CT45U22	180
2D4P6AIPV3R,BU	75	30RJ66SM	6	3106AMD39	185	3106CT45U30	180
2D4P6IPV3B	53	30RJ66SMT	6	3106AMD45	185	3106D458076	159
2F12CMIOR50	102	30RJSM5/10	30	3106AMD4524	185	3106D459060	158
2F12CMOLDN	104	31003U180MDF	8	3106BMMD39	185	3106DA12U	188
2F12CMOLPN50	105	3100A230/1	14	3106BMMD45	185	3106DA6U	188
2F12CSOLDN	106	3100C100MDF	11, 62	3106BMMD4524	185	3106DMA12U	188
2F12MMIOLR	101	3100C100MDF,TR	11	3106C398060	160	3106DMA18U	188
2F12S12MOLDN	107	3100C250MDF	11, 62	3106C399060	161	3106DP18	185
2F24CMIOR50	102	3100CMH	10, 65	3106C4510060	164	3106DP27	185
2F24CMOLDN	104	3100CMV100F	10, 65	3106C458060	162	3106DP39	185
2F24CSOLDN	106	3100CMV250F	10, 65	3106C458076	165	3106DP45	185
2F24MMIOLR	101	3100E100IDF	12	3106C459060	163	3106DP4524	185
2F4CMIOHB	103	3100E10IDFL	12	3106C459076	166	3106EB12	181
2F4CMIOR50	102	3100E20IDFL	12	3106CAB18C60	128	3106EBV18	181
2F4CMOLDN	104	3100E30IDF	12	3106CAB18F60	143	3106EBV39	181
2F4CMOLPN50	105	3100E50IDF	12	3106CAB27C60	129	3106EBV45	181
2F4MMIOLR	101	3100E50IDFIP	13	3106CAB27F60	144	3106EK	181
2F6CMIOHB	103	3100EXIDF	13	3106CAB39C60	130	3106FT260	181
2F6CMIOR50	102	3100F100F	8	3106CAB39C80	131	3106FT460	181
2F6CMOLDN	104	3100F100MDF	8	3106CAB39F60	145	3106FT660	181
2F6CMOLPN50	105	3100F100MDFC	9	3106CAB39F80	146	3106GD45	185
2F6CSOLDN	106	3100F250MDF	8	3106CAB45C100	135	3106HWC12U35	174
2F6MMIOLR	101	3100F250MDFC	9	3106CAB45C1024	140	3106HWC12U50	175
2F6S12MOLDN	107	3100F540MDF	8	3106CAB45C110	136	3106HWC6U35	172
2F6S6MOLDN	107	3100F540MDFC	9	3106CAB45C120	137	3106HWM12U35	174
2F6SMIOLR	100	3100LAB1HLDR	7	3106CAB45C1224	141	3106HWM12U50	175
2F8CMIOR50	102	3100LABHLDRH	7	3106CAB45C1224	142	3106HWM18U35	176
2F8CMOLDN	104	3100LHLDR	7	3106CAB45C60	132	3106HWM18U50	177
2F8CMOLPN50	105	3100M10/3	14	3106CAB45C80	133	3106HWM6U35	172
2F8CSOLDN	106	3100RB1000	14	3106CAB45C824	138	3106HWM6U45	173
2F8MMIOLR	101	3100RB250	14	3106CAB45C90	134	3106HWMK12U	188

Index by Catalogue Number

3106HWMK18U	188	3106TR80	184	900/16/16C	205	C2033VH	83
3106HWMK6U	188	3106TV60	184	900/16/16EE	204	C2033VI	83
3106JK	181	3106TVCM39	187	900/16/16EI	204	C2034HI	83
3106LR24	179	3106TVCM45	187	900/16/16P	202	C2034VH	83
3106LR39	179	3106VCMD27	190	900/16/16PT	200	C2034VI	83
3106LR45	179	3106VCMD45	190	900/16A16	203	C2035HI	83
3106MD27	185	3106VPM18U	184	900/25/16	200	C2035VH	83
3106MD39	185	3106VPM39U	184	900/25/16C	205	C2035VI	83
3106MD45	185	3106VPM45U	184	900/25/16EE	204	C2036HI	83
3106MD4524	185	3106VPMW12U	189	900/25/16EI	204	C2036VH	83
3106PH10W2FP	182	3106VPMW18U	189	900/25/16P	202	C2036VI	83
3106PH6W1FP	182	3106VPMW6U	189	900/25/16PT	200	C242/20	196
3106PH6W2FP	182	3106VSP18U60	186	900/25/16TL	206	C242/25	196
3106PV10WJB	182	3106VSP27U60	186	900/25/16TR	206	C242/32	196
3106PV13W2FP	182	3106VSP39U60	186	900/25/25	200	C242/40	196
3106PV16W2FP	182	3106VSP39U80	186	900/25/25PT	200	C242/50	196
3106PV16WJB	182	3106VSP39U90	186	900/25A25	203	C244/20	195
3106PV20W2FP	182	3106VSP45U100	186	900/40/16	200	C244/25	195
3106PV20WJB	182	3106VSP45U110	186	900/40/25	200	C244/32	195
3106SC2U23	183	3106VSP45U120	186	900/40/25/2	200	C245/20	195
3106SC2U28	183	3106VSP45U60	186	900/40/25C	205	C245/25	195
3106SC3U30	183	3106VSP45U80	186	900/40/25EE	204	C246/20	195
3106SC5U50	183	3106VSP45U90	186	900/40/25EI	204	C246/25	195
3106SC6U60	183	3106WC12U35	174	900/40/25P	202	C246/32	195
3106SF1U101	183	3106WC12U50	175	900/40A25	203	C247/20	196
3106SF1U41	183	3106WC18U35	176	900/40TA25	203	C247/25	196
3106SF1U45	183	3106WC18U50	177	900/50/25	200	C247/32	196
3106SF1U61	183	3106WC6U35	172	900/50/50	201	C247L20	196
3106SF1U71	183	3106WC6U45	173	900/50/50EE	204	C247L25	196
3106SF1U75	183	3106WFH2U12	178	900/50/50EI	204	C247L32	196
3106SF1U81	183	3106WFH2U20	178	900/50/50P	202	C247L50	196
3106SF1U91	183	3106WFH4U12	178	900/50C	205	RJ1HUDSR	39, 55, 77
3106SP18U60	186	3106WFH4U20	178	900/60/25	200	RJ1HUSSR	39, 55, 77
3106SP27U60	186	3106WFH6U30	178	900/60/40	200	RJ1UCMPC	38, 54, 76
3106SP39U60	186	3106WTC12U35	169	900/75/50	201	RJ1UCMPSC	38
3106SP39U80	186	3106WTC12U50	170	900/75/50EE	204	RJ45SMA5	31
3106SP45U100	186	3106WTC12URR	189	900/75/50EI	204	RJ45SMA5SH	33
3106SP45U120	186	3106WTC18U50	171	900/75/50P	202	RJ45SMA6	47
3106SP45U60	186	3106WTC618URR	189	900/75/75	201	RJ45SMA6A	71
3106SP45U80	186	3106WTC6U35	167	900/75/75EE	204	RJ45SMA6AS	73
3106SP45U90	186	3106WTC6U50	168	900/75/75EI	204	RJ45SMA6SH	49
3106SPL	186	3106WTC6URR	189	900/75/75P	202	RJ5/05PL	29
3106ST1U41	183	31VRJ	85	900/75C	205	RJ5/100PL	29
3106ST1U61	183	4031VH	80	900AT12	209	RJ5/10PL	29
3106ST2U61HD	183	4032VH	80	900AT18	209	RJ5/15PL	29
3106ST2U71HD	183	4033VH	80	900AT24	209	RJ5/16PP	34
3106TC27C1024	118	4034VH	80	900C75	206	RJ5/20PL	29
3106TC27C1224	119	4036VH	80	900CC	206	RJ5/24PP	34
3106TC27C824	116	5LT	215	900D50S	206	RJ5/30PL	29
3106TC27C924	117	5LTU	215	900D75S	206	RJ5/50PL	29
3106TC39C1024	122	900/100/100	201	900MBC	208	RJ5/6CTWLS	36, 52
3106TC39C1224	123	900/100/100P	202	900RMB	207	RJ5A1/16PP	34
3106TC39C824	120	900/100/50	201	900SPBP	208	RJ5A1/24PP	34
3106TC39C924	121	900/100/50EE	204	900SPMB	207	RJ5H1/16PP	35
3106TC45C1024	126	900/100/50EI	204	95CMCSC/A	110	RJ6/05PL	45
3106TC45C1224	127	900/100/50P	202	95CMCST/A	110	RJ6/10PL	45
3106TC45C824	124	900/100/75	201	C2000A4L	86	RJ6/15PL	45
3106TC45C924	125	900/100/75EE	204	C2031HI	83	RJ6/20PL	45
3106TCD55/100	187	900/100/75EI	204	C2031VH	83	RJ6/24PPSH	51
3106TCJK	181	900/100/75P	202	C2031VI	83	RJ6/30PL	45
3106THCM100	187	900/100C	205	C2031VX	83	RJ6/50PL	45
3106THCM80	187	900/150/50	201	C2032HI	83	RJ6A1/24PP	50
3106THCM90	187	900/150/75	201	C2032VH	83	RJ6AF8A10LPL	69
3106TP60	184	900/16/10	200	C2032VI	83	RJ6AF8A20LPL	69
3106TR60	184	900/16/16	200	C2033HI	83	RJ6AF8A30LPL	69

Index by Catalogue Number

RJ6AF8A50LPL	69	TFP1C3M16M05	94	TFP2L3M35M05	96
RJ6AU/24PP	74	TFP1C3M16M10	94	TFP2L3M35M10	96
RJ6AU/24PPLS	74	TFP1C3M16M100	94	TFP2L3M35M100	96
RJ6AU/24PPS	74	TFP1C3M16M20	94	TFP2L3M35M20	96
RJ88P	29	TFP1C3M16M50	94	TFP2L3M35M50	96
SC2031VH	81	TFP1C3M35M05	96	TFP2L3S19S05	93
SC2031VHI	81	TFP1C3M35M10	96	TFP2L3S19S10	93
SC2032VH	81	TFP1C3M35M100	96	TFP2L3S19S100	93
SC2032VHI	81	TFP1C3M35M20	96	TFP2L3S19S20	93
SC2033VH	81	TFP1C3M35M50	96	TFP2L3S19S50	93
SC2033VHI	81	TFP1C3S19S05	93	TFP2T3M16M05	94
SC2034VH	81	TFP1C3S19S10	93	TFP2T3M16M10	94
SC2034VHI	81	TFP1C3S19S100	93	TFP2T3M16M100	94
SC2035VH	81	TFP1C3S19S20	93	TFP2T3M16M20	94
SC2035VHI	81	TFP1C3S19S50	93	TFP2T3M16M50	94
SC2036VH	81	TFP1L3S19S05	93	TFP2T3M35M05	96
SC2036VHI	81	TFP1L3S19S10	93	TFP2T3M35M10	96
SC240L	199	TFP1L3S19S100	93	TFP2T3M35M100	96
SC242/20	199	TFP1L3S19S20	93	TFP2T3M35M20	96
SC242/25	199	TFP1L3S19S50	93	TFP2T3M35M50	96
SC242/32	199	TFP1T3M16M05	94	TFP2T3S19S05	93
SC242/40	199	TFP1T3M16M10	94	TFP2T3S19S10	93
SC242/50	199	TFP1T3M16M100	94	TFP2T3S19S100	93
SC245/20	199	TFP1T3M16M20	94	TFP2T3S19S20	93
SC245/25	199	TFP1T3M16M50	94	TFP2T3S19S50	93
SC246/16	198	TFP1T3M35M05	96	TFP2TC3M16M05	95
SC246/20	198	TFP1T3M35M10	96	TFP2TC3M16M10	95
SC246/25	198	TFP1T3M35M100	96	TFP2TC3M16M100	95
SC246/32	198	TFP1T3M35M20	96	TFP2TC3M16M20	95
SC247/20	198	TFP1T3M35M50	96	TFP2TC3M16M50	95
SC247/25	198	TFP1T3S19S05	93	TFP2TC3M35M05	97
SC247/32	198	TFP1T3S19S10	93	TFP2TC3M35M10	97
SC263/20	197	TFP1T3S19S100	93	TFP2TC3M35M100	97
SC263/25	197	TFP1T3S19S20	93	TFP2TC3M35M20	97
SC263/32	197	TFP1T3S19S50	93	TFP2TC3M35M50	97
SC263/40	197	TFP2C3M16M05	94	TFT12C3M16M10	99
SC263/50	197	TFP2C3M16M10	94	TFT12C3M35M10	99
SL2031VH	82	TFP2C3M16M100	94	TFT12C3S19S10	99
SL2031VHI	82	TFP2C3M16M20	94	TFT12L3M16M10	99
SL2032VH	82	TFP2C3M16M50	94	TFT12L3M35M10	99
SL2032VHI	82	TFP2C3M35M05	96	TFT12L3S19S10	99
SL2033VH	82	TFP2C3M35M10	96	TFT1C3M16M10	98
SL2033VHI	82	TFP2C3M35M100	96	TFT1C3M16M20	98
SL2034VH	82	TFP2C3M35M20	96	TFT1C3M35M10	98
SL2034VHI	82	TFP2C3M35M50	96	TFT1C3M35M20	98
SL2035VH	82	TFP2C3S19S05	93	TFT1C3S19S10	98
SL2035VHI	82	TFP2C3S19S10	93	TFT1C3S19S20	98
SL2036VH	82	TFP2C3S19S100	93	TFT1L3M16M10	98
SL2036VHI	82	TFP2C3S19S20	93	TFT1L3M16M20	98
SMRJ45A5/1	41	TFP2C3S19S50	93	TFT1L3M35M10	98
SMRJ45A5/2	41	TFP2CL3M16M05	95	TFT1L3M35M20	98
SMRJ45A5/4	41	TFP2CL3M16M10	95	TFT1L3S19S10	98
SMRJ45A5/6	41	TFP2CL3M16M100	95	TFT1L3S19S20	98
SMRJ45A6/1	57	TFP2CL3M16M20	95	TFT1T3M16M10	98
SMRJ45A6/2	57	TFP2CL3M16M50	95	TFT1T3M16M20	98
SMRJ45A6/4	57	TFP2CL3M35M05	97	TFT1T3M35M10	98
SMRJ45A6/6	57	TFP2CL3M35M10	97	TFT1T3M35M20	98
TFM1U	90	TFP2CL3M35M100	97	TFT1T3S19S10	98
TFM1UBLANKP	92	TFP2CL3M35M20	97	TFT1T3S19S20	98
TFM1UF	91	TFP2CL3M35M50	97	TRJ45PDT	214
TFM1ULCD4P	92	TFP2L3M16M05	94	TRJ45PDTB	214
TFM1ULCD8P	92	TFP2L3M16M10	94		
TFM1USCD4P	92	TFP2L3M16M100	94		
TFM1USTS8P	92	TFP2L3M16M20	94		
TFMSPT	91	TFP2L3M16M50	94		

Clipsal Datacomms Lifetime Warranty

Our Product Portfolio & Warranty Offer

Clipsal Datacomms provides a complete end-to-end solution, with products catering to any type or size of installation. Our comprehensive range ensures that installers and end-users have the convenience of purchasing from one vendor and having their network system covered by the industry leading lifetime warranty. The lifetime warranty is fully outlined on page 218 of this Product Selection Guide.

Our product portfolio incorporates:

- Voice Equipment
- Structured Cabling Solutions
- Fibre Optic
- Workstation Outlets
- Cable Management
- Systems Enclosures
- Copper and Fibre Optic Cables
- Conduit and Ducting
- Inter-building Cabling
- Cabinet Accessories (fan trays, power rails, etc).

Clipsal Datacomms offers comprehensive training programs for consultants and installers alike. Installer accreditation is coupled with innovative product and a system lifetime warranty program to provide end users with peace of mind.

The Clipsal Datacomm's warranty is only issued after third party verification of installation results through NATA to ensure the highest standard of compliance.

Clipsal Datacomms is exclusive in offering cabinets, underground cables, pathways and spaces, as well as cable and cross connect product all under the one warranty, giving credence to our adage "the complete end-to-end solution".

 **CLIPSAL**[®]

by Schneider Electric 235



by **Schneider** Electric

Clipsal Australia Pty Ltd

A member of Schneider Electric

Head Office

33-37 Port Wakefield Road, Gepps Cross
South Australia 5094

printed on recycled paper

clipsal.com

Website clipsal.com
Contact us clipsal.com/feedback

National Customer Care Enquiries:
1300 2025 25

Clipsal Australia Pty Ltd reserves the right to change specifications, modify designs and discontinue items without incurring obligation and whilst every effort is made to ensure that descriptions, specifications and other information in this catalogue are correct, no warranty is given in respect thereof and the company shall not be liable for any error therein.

© Clipsal Australia Pty Ltd.